



United States Department of Agriculture

National Proceedings: Forest and Conservation Nursery Associations—2013



Forest Service

Rocky Mountain Research Station

Proceedings RMRS-P-72

December 2014

Wilkinson KM, Haase DL, Pinto JR, technical coordinators. 2014. **National Proceedings: Forest and Conservation Nursery Associations—2013**. Fort Collins, CO: U.S. Department of Agriculture, Forest Service, Rocky Mountain Research Station. Proc. RMRS-P-72. 79 p.

Available at: http://www.fs.fed.us/rm/pubs/rmrs_p072.html

Abstract

These proceedings are a compilation of 14 papers that were presented at the regional meetings of the forest and conservation nursery associations in the United States in 2013. The Joint Northeast and Southern Forest Nursery Conference was held at the Holiday Inn City Centre, Lafayette, Indiana, July 22 to 25, 2013. Subject matter for the technical sections included nursery fertilization, black walnut research, and exploring the threat of hybrid Phytophthoras (and how to prevent this). Field trips included tours of the Purdue Department of Forestry and Natural Resources, the Hardwood Tree Improvement and Regeneration Center plantings, the Martell Forest –Wright Forestry Center, ArborAmerica, and Vallonia Nursery. The meeting of the Western Forest and Conservation Nursery Association was held at the Red Lion Hotel, Olympia, Washington, August 6 to 7, 2013. Subject matter for the sessions was themed around management of soils, growing media, and roots in the production of forest and conservation seedlings. This included tree pathology, Methyl Bromide alternatives, mycofiltration technology, photoperiod manipulation, fertilization, root zone heating, evaluating alternative growing media components and conducting effective research in the nursery. The meeting was hosted by the Washington Department of Natural Resources (DNR). An afternoon field trip included tours of Washington DNR's Meridian Seed Orchard, Lawyer Nursery, and Washington DNR's Webster Nursery. Evening presentations centered around the local area, historic shellfish growing, and tree farms.

Key Words—bareroot nursery, container nursery, nursery practices, fertilization, pest management, seeds, reforestation, restoration, tree physiology, hardwood species, native species

Papers were edited to a uniform style; however, authors are responsible for content and accuracy.

Pesticide Precautionary Statement

This publication reports research involving pesticides. It does not contain recommendations for their use, nor does it imply that the uses discussed here have been registered. All uses of pesticides must be registered by the appropriate state and/or federal agencies before they can be recommended.

CAUTION: Pesticides can injure humans, domestic animals, desirable plants, fish, and wildlife if they are not handled or applied properly. Use all pesticides selectively and carefully. Follow recommended practices for the disposal of surplus pesticides and their containers.

The use of trade or firm names in this publication is for reader information and does not imply endorsement of any product or service by any of the organizations represented here.

National Proceedings: Forest and Conservation Nursery Associations—2013

Technical Coordinators:

Kim M Wilkinson is an Environmental Management Specialist, 3-693 Corlett Road, Gibsons BC V0N 1V9 Canada; E-mail: kim.m.wilkinson@gmail.com

Diane L Haase is Western Nursery Specialist, USDA Forest Service, PO Box 3623, Portland, OR 97208; Tel: 503.808.2349; E-mail: dlhaase@fs.fed.us

Jeremiah R Pinto is Research Plant Physiologist, USDA Forest Service, Rocky Mountain Research Station, 1221 South Main Street, Moscow, ID 83843; Tel: 208.883.2352; E-mail: jpinto@fs.fed.us

Acknowledgments:

The Funding for this publication was provided as a technology transfer service by the USDA Forest Service, State and Private Forestry through the National Reforestation, Nurseries, and Genetic Resources (RNCR) Program. The compilers thank Jim Marin, Lane Eskew, Nancy Chadwick, and Phillip Cates for their assistance in the preparation, printing, and distribution of this publication.

Searchable Internet Database—www.rngr.net

The National Nursery Proceedings database includes papers published in the regional nursery proceedings (Western, Intermountain, Northeastern, and Southern) since 1949. The database can be searched by date, author, or keyword and papers are available in portable document format (PDF).

Table of Contents

Joint meeting of the Northeast Forest and Conservation Nursery Association and Southern Forest Nursery Association, Lafayette, Indiana, July 22 to 25, 2013

Advances in Fertilization for Forest Regeneration. 3
Douglass F Jacobs

Performance of Select Walnut in Indiana After 10 Years 6
James R McKenna and Philip A O'Connor

The Threat of Hybrid *Phytophthoras* 12
Janna Beckerman, Stephen Goodwin and Kevin Gibson

Meeting photos 18-20

Western Forest and Conservation Nursery Association Meeting, Olympia, Washington, August 6 to 7, 2013

Implementing Fungal Cultivation in Biofiltration Systems – The Past, Present, and Future of Mycofiltration 23
Alex W Taylor and Paul E Stamets

Biofumigation Potential of *Brassica* Soil Amendments in Douglas-fir Seedlings. 29
Bodh R Paudel and Lynne A Carpenter-Boggs

Soil Fumigation: Regulatory Update, Phase II Labels, Buffer Zone Specifics. 35
Jeff Fowler

Understanding the Pathology of Douglas-fir Seedlings in Pacific Northwest Nurseries 38
Jerry Weiland

Effect of Nursery Photoperiod Manipulation on Coastal Douglas-fir Seedling Root Development Following Planting 41
Douglass F Jacobs

Quantification of *Fusarium commune* in Douglas-fir Seedling Nurseries 44
Anna Leon

Evaluating Alternative Growing Media Components 50
Richard P Regan

Benefits of Small-Prill Controlled-Release Fertilizer in Container Production 54
Nabil Khadduri

New and Emerging Herbicide Tools for Weed Control in Conifer Nurseries 57
Tim Miller and Ed Peachey

Root Zone Heating Systems 62
John W Bartok

Beyond Cowboy Science: Simple Methods for Conducting Credible and Valid Research 66
Diane L Haase

Meeting photos 78-79

Joint meeting of the Northeast Forest and Conservation Nursery Association and Southern Forest Nursery Association

Lafayette, Indiana

July 22 to 25, 2013



Joint meeting of the Northeast Forest and Conservation Nursery
Association and Southern Forest Nursery Association

Illustration courtesy of College of Natural Resources, University of Idaho

Advances in Fertilization for Forest Regeneration

Douglass F Jacobs

Douglass F Jacobs is the Fred M. van Eck Professor of Forest Biology with the Hardwood Tree Improvement and Regeneration Center, Department of Forestry and Natural Resources, Purdue University, West Lafayette, IN 47907; E-mail: djacobs@purdue.edu

Jacobs, DF. 2014. Advances in Fertilization for Forest Regeneration. In: Wilkinson KM, Haase DL, Pinto JR, technical coordinators. National Proceedings: Forest and Conservation Nursery Associations—2013. Fort Collins (CO): USDA Forest Service, Rocky Mountain Research Station. Proceedings RMRS-P-72. 3-5. Available at: http://www.fs.fed.us/rm/pubs/rmrs_p072.html

Abstract: Advancements in fertilizer products and application methods have led to improvements in reforestation and restoration productivity. Supplemental nutrition through fertilization is necessary to produce high quality nursery seedlings and is important to help overcome nutrient deficiencies on some field sites. Nursery nutrient loading is a relatively new technique that may be used to maximize seedling nutrient content; these nutrients may then be re-translocated (mobilized from old to new tissues [Salifu and others 2008, 2009a]) to support new growth following field planting. While effects on plant cold hardiness are a potential risk when applying high fertilization rates in fall, most studies have shown a positive relationship between nitrogen fertilization and frost resistance. Field fertilization using controlled-release fertilizer has also recently emerged as an effective means of stimulating early growth of planted trees. Increased browse susceptibility of field-fertilized trees is a valid concern, but responses are species-specific and past research has mainly focused on broadcast applications of immediately available fertilizer. Future research examining targeted root zone application of controlled-release fertilizer across more silvicultural systems may continue to provide important new insight into the relationship.

Key Words: controlled-release fertilizer, nitrogen, nutrient loading, nursery propagation, seedling quality

Introduction

This paper presents an overview of recent research by the Hardwood Tree Improvement and Regeneration Center (HTIRC) at Purdue University and elsewhere to examine new techniques in fertilization for reforestation and restoration. Much of the HTIRC's work has focused on hardwood species, although some projects have examined responses of conifers. Many of the discoveries and advances in regeneration technologies made over the last several decades with conifers have since been tested for a diverse group of temperate deciduous species in eastern North America including oaks, walnuts, chestnut and cherry (Jacobs 2011). This paper covers a brief overview of why and when to fertilize, the concept of nursery nutrient loading and its application to hardwoods, the influence of nutrient loading on seedling cold hardening, recent advances in fertilization at field planting, and the influence of fertilization on browse susceptibility.

Why and When to Fertilize?

Following germination, most forest trees quickly deplete nutrients stored in seeds and must rely upon nutrient taken up from the soil. Many basic plant physiological processes depend upon adequate plant nutrient levels, and nutrient-deprived seedlings generally have reduced photosynthesis, grow poorly, and are more susceptible to stresses. Thus, quality of seedlings grown in nurseries depends strongly on provision of supplemental nutrition. Large, nutrient rich seedlings usually establish better in the field, especially under harsh site conditions characteristic of many forest restoration projects (Villar-Salvador and others 2012). As expectations for reforestation productivity continue to rise, fertilization at or soon after planting is also increasingly used to overcome site limitations especially when the goal is to maximize fiber production (Fox

2000). For these reasons, fertilization has long been a part of nursery propagation and silvicultural management in the field; technological advances over the last several decades have made fertilization programs more commonplace and efficient (Jacobs and Timmer 2005; Haase and Jacobs 2013).

Nutrient Loading of Nursery Stock

Introduced in the late-1990s, nursery nutrient loading has been studied extensively with boreal conifers and relies upon the premise that fertilization inputs should be matched to plant demand by exponentially increasing supply over the course of the growing period (Timmer 1997). As detailed in Salifu and Jacobs (2006), the goal of nutrient loading is to maximize plant nutrient (i.e., nitrogen) content by fertilizing at a level that promotes luxury nutrient uptake without causing toxicity. This is done most effectively through exponential increases of fertilizer supply, which helps to improve fertilizer use efficiency and decrease nutrient leaching (Dumroese and others 2005).

This practice has recently been studied for hardwoods in the Central Region of the U.S., which are usually produced in bareroot nurseries and characterized by survival rates around 65% (Jacobs and others 2004). Many hardwood seedlings are also planted onto relatively harsh sites, such as those being reclaimed after mining operations. We have shown that exponential fertilization can be successfully applied to nursery propagation of container (Salifu and Jacobs 2006) and bareroot (Birge and others 2006) seedlings. These stored nutrients may then be re-translocated to support new growth following field planting (Salifu and others 2008; 2009a), which may enhance field performance (Salifu and others 2009b). Increased nutrient storage in nutrient loaded trees along with demonstrated improvements in fertilizer use efficiency through exponential fertilization have prompted some operational nurseries to begin using this fertilization technique.

Nutrient Loading and Cold Hardening

One potential concern of nutrient loading via high rates of fertilizer application late in the growing season is that seedlings may not adequately harden prior to exposure to fall frost. Research results concerning effects of fertilization on frost hardiness of forest trees vary widely, but a recent review of about 50 papers published since 1990 examining responses of plants (i.e., mainly forest trees) reported that the positive effects of nitrogen for plant frost hardiness exceeded the negative effects (Taulavuori and others 2014). Responses varied largely on nutrient supply, nitrogen source, and tissue nitrogen concentrations. We examined red pine (*Pinus resinosa*) cold hardiness in response to fall fertilization with a wide range of ammonium nitrate rates (Islam and others 2009). In support of the aforementioned trend, seedlings fertilized at the highest rate (89 kg N ha⁻¹ [79 lb N ac⁻¹]) had greater cold tolerance than those fertilized at 0 or 11 kg N ha⁻¹ (9.8 lb N ac⁻¹). Thus, while knowledge of late-season fertilization is still incomplete, nutrient loading is unlikely to negatively effect cold tolerance if done with informed caution.

Fertilization at Planting

Field fertilization provides another means of alleviating nutrient deficiencies in forest trees during the plantation establishment phase. Improvements in controlled-release fertilization technology allow for targeted application of fertilizer to seedling root systems (figure 1) and gradual fertilizer release for up to 2 years with a single application

(Jacobs and Timmer 2005; Jacobs and others 2005). This has been shown to improve early plantation growth in a variety of silvicultural systems. For example, fertilization with 60 g (about 2 oz) per seedling of a 15N-9P-10K (plus other macros and minors) 16-18 month release rate controlled release fertilizer increased first-year height and root-collar diameter growth by 52 and 33%, respectively, for three hardwood species on an afforestation site in Indiana (Jacobs and others 2005). Similarly, Sloan and Jacobs (2013) reported that 15N-9P-10K controlled-release fertilizer improved growth of white spruce (*Picea glauca*) and aspen (*Populus tremuloides*) compared to unfertilized controls on a mine reclamation site in northern Alberta. In this study, controlled-release fertilization produced equal or better responses to fertilization with a 20N-20P-20K immediately available fertilizer, but at 90-95% lower nitrogen application rates.

Fertilization and Browse Damage

Regardless of whether nutrient loading or field fertilization is used to enhance seedling tissue nutrient levels in forest regeneration programs, another potential concern is the possibility for increased susceptibility of fertilized trees to browsing. Burney and Jacobs (2013) recently reviewed the literature on this topic and concluded that while a generally higher likelihood of browsing occurs for fertilized trees, species-specific exceptions to this trend exist. For example, western red-cedar (*Thuja plicata*) preferentially allocates nutrient resources toward plant chemical defenses (e.g., terpenoids), which may actually



Figure 1. Targeted application of controlled-release fertilizer to the root zone of white spruce (*Picea glauca*) on a field planting site.

decrease likelihood of browsing for fertilized trees (Burney and Jacobs 2011; Burney and others 2012). Additionally, most past studies on this theme have used broadcast application of immediately available fertilizer, thereby increasing nutritional value not only for trees, but for all vegetation on the site (Burney and Jacobs 2013). Thus, future research with controlled-release fertilizer across more combinations of species and silvicultural systems may find that growth benefits could generally outweigh the negative impacts of browse.

References

- Birge ZKD, Salifu KF, Jacobs DF. 2006. Modified exponential nitrogen loading to promote morphological quality and nutrient storage of bareroot-cultured *Quercus rubra* and *Quercus alba* seedlings. *Scandinavian Journal of Forest Research* 21:306-316.
- Burney OT, Jacobs DF. 2011. Ungulate herbivory of regenerating conifers in relation to foliar nutrition and terpenoid production. *Forest Ecology and Management* 262:1834-1845.
- Burney OT, Jacobs DF. 2013. Ungulate herbivory of forest regeneration in relation to plant mineral nutrition and secondary metabolites. *New Forests* 44:753-768.
- Burney OT, Davis AS, Jacobs DF. 2012. Phenology of foliar and volatile terpenoid production for *Thuja plicata* families under differential nutrient availability. *Environmental and Experimental Botany* 77:44-52.
- Dumroese RK, Page-Dumroese DS, Salifu KF, Jacobs DF. 2005. Exponential fertilization of *Pinus monticola* seedlings: nutrient uptake efficiency, leaching fractions, and early outplanting performance. *Canadian Journal of Forest Research* 35:2961-2967.
- Fox TR. 2000. Sustained productivity in intensively managed forest plantations. *Forest Ecology and Management* 138:187-202.
- Haase DL, Jacobs DF. 2013. Nutrient dynamics of planted forests. *New Forests* 44:629-633.
- Islam MA, Apostol KG, Jacobs DF, Dumroese RK. 2009. Fall fertilization of *Pinus resinosa* seedlings: nutrient uptake, cold hardiness, and morphological development. *Annals of Forest Science* 66:704.
- Jacobs DF. 2011. Targeting hardwoods. In Riley, L.E., Haase, D.L., and Pinto, J.R., technical coordinators. *National Proceedings: Forest and Conservation Nursery Associations-2010*. USDA Forest Service Rocky Mountain Research Station Proceedings RMRS-P-65:115-120.
- Jacobs DF, Timmer VR. 2005. Fertilizer-induced changes in rhizosphere electrical conductivity: relation to forest tree seedling root system growth and function. *New Forests* 30:147-166.
- Jacobs DF, Ross-Davis AL, Davis AS. 2004. Establishment success of conservation tree plantations in relation to silvicultural practices in Indiana, USA. *New Forests* 28: 23-36.
- Jacobs DF, Salifu KF, Seifert JR. 2005. Growth and nutritional response of hardwood seedlings to controlled-release fertilization at outplanting. *Forest Ecology and Management* 214:28-39.
- Salifu KF, Jacobs DF. 2006. Characterizing fertility targets and multi-element interactions for exponential nutrient loading of *Quercus rubra* seedlings. *Annals of Forest Science* 63:231-237.
- Salifu KF, Apostol KG, Jacobs DF, Islam MA. 2008. Growth, physiology, and nutrient retranslocation in nitrogen-15 fertilized *Quercus rubra* seedlings. *Annals of Forest Science* 65:101.
- Salifu KF, Islam MA, Jacobs DF. 2009a. Retranslocation, plant and soil recovery of nitrogen-15 applied to bareroot *Juglans nigra* seedlings. *Communications in Soil Science and Plant Analysis* 40:1408-1417.
- Salifu KF, Jacobs DF, Birge ZKD. 2009b. Nursery nitrogen loading improves field performance of bareroot oak seedlings planted on abandoned mine land. *Restoration Ecology* 17:339-349.
- Sloan JL, Jacobs DF. 2013. Fertilization at planting influences seedling growth and vegetative competition on a post-mining boreal reclamation site. *New Forests* 44:687-701.
- Taulavuori K, Taulavuori E, Sheppard LJ. 2014. Truths or myths, fact or fiction, setting the record straight concerning nitrogen effects on levels of frost hardiness. *Environmental and Experimental Botany*. <http://dx.doi.org/10.1016/j.envexpbot.2013.12.022>.
- Timmer VR. 1997. Exponential nutrient loading: a new fertilization technique to improve seedling performance on competitive sites. *New Forests* 13: 279 – 299.
- Villar Salvador P, Puértolas J, Cuesta B, Peñuelas Rubira J, Uscola, M, Heredia-Guerrero N, Rey Benayas JM. 2012. Increase in size and nitrogen concentration enhances seedling survival in Mediterranean plantations. Insights from an ecophysiological conceptual model of plant survival. *New Forests* 43:755-770.

Performance of Select Walnut in Indiana After 10 Years

James R McKenna and Philip A O'Connor

James R McKenna, Operational Tree Breeder, USDA Forest Service, Northern Research Station Purdue University Department of Forestry & Natural Resources, West Lafayette, IN 47907; E-mail: jrmckenn@purdue.edu

Philip A O'Connor, Tree Improvement Specialist, Indiana Department of Natural Resources Division of Forestry, Vallonia, IN 47281; E-mail: poconnor@dnr.IN.gov

McKenna JR, O'Connor PA. 2014. Performance of Select Walnut in Indiana after 10 Years. In: Wilkinson KM, Haase DL, Pinto JR, technical coordinators. National Proceedings: Forest and Conservation Nursery Associations—2013. Fort Collins (CO): USDA Forest Service, Rocky Mountain Research Station. Proceedings RMRS-P-72. 6-11. Available at: http://www.fs.fed.us/rm/pubs/rmrs_p072.html

Abstract: Ten-year growth and stem quality of seedlings were compared among seven black walnut (*Juglans nigra*) populations and one half-sibling ("half-sib") family. Seed was collected and sown in the fall of 2001 in the Indiana Division of Forestry (IN DoF) Vallonia Nursery, and 1-0 seedlings were out-planted at two central Indiana sites in 2003. A companion planting of half-sib seedlings from a single phenotypic plus-tree selection was planted adjacent to each test planting by direct seeding in May 2003. Growth varied significantly between sites but was not statistically significant among populations at either site after ten years. Population, however, had a highly significant effect on timber-form quality. Significantly better stem quality was observed for the two select seed sources and the companion half-sib family. Average performance of the two select orchard populations was 13 percent above the plantation mean based on a compilation of all measured criteria.

Key Words: plus-tree selection, forest tree improvement, plantation forestry, progeny testing, seed source testing

Introduction

Black walnut (*Juglans nigra* L.) has historically been one of the most valuable timber species in the Central Hardwood Region of the US (Funk 1973), used to produce fine furniture, cabinetry, molding, and paneling (Cassens 2004). Throughout the last century, it was believed that the genetic quality of black walnut had been eroded due to high grading (Schmidt and Kingsley 1997; McGuire and others 1999). The supply of merchantable walnut logs was in decline by the early 1970s (Hoover 1995). State and federal agencies, partnered with Land Grant Universities in an attempt to mitigate this scarcity, and improve the genetic quality of future walnut timber. The shared goal among groups was to develop both high-quality and faster growing walnut seedling stock. By the 1970s and 1980s, regional cooperatives, supported by the U.S. Forest Service, began testing regional provenances and half-sibling families of walnut to identify geographically adapted, superior genetic sources for seed orchards (Bey 1980; Beineke 1989). All initial accessions in these programs were phenotypic plus-tree selections based on wild trees with very straight apically dominant stems with few defects, and high growth rates.

Walnut seed collected for forestry purposes is rarely collected from natural forest stands. Seed collectors typically harvest walnut seed from more accessible street, yard, park, and cemetery trees. Collectors view mowed lawns where understory vegetation is absent as ideal. Most collectors harvest trees that are accessible to a vehicle in order to facilitate loading seed, since black walnut is among one of the heaviest hardwood seeds. Only seven to eight fresh walnut seeds weigh one pound (Bonner and Karrfalt 2008). More importantly, forest conditions present severe challenges to both walnut seed production and collection since small tree crowns, low light conditions, and intense predation all combine to reduce the number of harvestable walnuts. Instead, walnut collectors prefer mostly open grown trees with large crops to maximize their labor return.

Many of the early black walnut progeny tests were planted “off-site” on soils that were not suited to vigorous walnut growth (Victory and others 2004). Little useful information was obtained from these studies beyond the admonition to only plant future progeny tests on land well suited to walnut. The present study was established on two moderately suitable walnut sites based on the recent black walnut suitability index (Wallace and Young 2008). This study is designed to demonstrate the increase in performance for some of the top-ranked selections in Indiana from an Indiana Division of Forestry (IN DoF) seed orchard and from a Purdue University clone bank (West Lafayette, IN) compared to seeds provided by local collectors in the area. In contrast to the bulk mixed seed of multi-tree populations, we also included a single open-pollinated half-sib family, from a previously untested plus-tree selection in the Purdue collection, to examine the performance of the progeny from a single select parent.

Methods

Plant Material

Seeds were collected from trees representing seven discrete populations in the fall of 2001 (table 1). Populations of seed were identified during 2000 and 2001 to represent typical black walnut collection sites that supply the IN DoF State Nursery (Vallonia, IN), a wild-type forest source, and two select genetic sources composed of grafted clones selected as phenotypic plus-trees: the IN DoF Vallonia Subline 1 seed orchard and the Purdue University Martell Black Walnut Clone Bank 1. Additionally, about 1,000 open-pollinated seeds from clone #226 were harvested from the Martell Clone Bank 2 and stratified in 2002, to provide a single half-sib family with a low level of genetic variation. This seed was pre-germinated and direct seeded adjacent to each provenance test site one month after the larger populations were planted.

Nursery Production

Seeds from each population were bulked at harvest and hulled in a commercial walnut huller to remove husks. The seed was sown in uniform beds at the IN DoF State Nursery, in the fall of 2001, among other black walnut production beds. All seedlings were grown following standard IN DoF nursery practices including: pre-plant soil fumigation, winter mulching, hand and chemical weed control, fertilization, tap-root undercutting, and pest control. Prior to lifting, the stems of each population were painted a unique color to avoid misidentification in the field prior to lifting. A tractor drawn, PTO driven Fobro lifter was

set to an approximate 16 in (40.6 cm) depth to maximize the amount of root retained as the beds were lifted.

Outplanting Experimental Design

Seedlings of the seven bulk populations were planted at two central Indiana locations, near the cities of Fishers and Martinsville, in a randomized complete block design, with ten replicates of 30 seedlings per population at each site. Each randomly assigned population was planted as adjacent 15 tree row-plots at Fishers, or as 30-tree row-plots at Martinsville. White pine (*Pinus strobus*) was used as a single tree perimeter border at Fishers and green ash (*Fraxinus pennsylvanica*) was used as a single tree perimeter border at Martinsville.

Seedlings were planted in April 2003 as dormant 1-0 stock with a Whitfield mechanical tree planter. At the Fishers site, rows were spaced 9 ft (2.7 m) apart and trees within rows were spaced an average of 6 ft (1.8 m) apart. The layout was a rectangle with straight rows but the spacing within rows varied from ± 2 ft (0.6 m) as a consequence of using the mechanical planter without any spacing control. At the Martinsville site, the spacing was adjusted to accommodate additional plantings. Row and tree spacing was 7 ft by 7 ft (2.1 m X 2.1 m) and rows were contoured as the field was a narrow bottom-land hollow, bordered by curving hills. Like the Fishers site, in-row spacing fluctuated ± 2 ft (0.6 m). At each site, 400 sprouted seeds of the half-sib family (#226) were planted by hand one month later, adjacent to each plot, in 5 blocks of 80 trees at the same spacing as the seedlings within each block bordered by the species indicated above.

Soil Types

The soil at Fishers is an Ockley silt loam, fairly uniform, with a slight slope toward a creek. The NRCS Black Walnut Suitability Index (BWSI) characterizes this soil type as “well suited for walnut.” At Martinsville, two soil types occur: a Wilbur silt loam that the BWSI characterizes as “moderately well suited” for black walnut, and an Ava silt loam that the BWSI characterizes as “somewhat suited” for walnut. Unlike the Fishers site, the soil is quite variable with gravel and clay deposits in places, and neighboring hillsides that cause intermittent flooding during heavy rainfall events throughout the year. At Martinsville, trees grew dramatically different between the two soil types. Six blocks of the bulked populations that were planted on the Ava silt loam were ultimately discarded from the analysis as the soil proved unsuitable for walnut, leaving four blocks grown on the Wilbur soil to analyze. The half-sib family was planted on the Ava soil and the poorest half of those seedlings was discarded from the analysis.

Table 1. Location and number of trees for each Indiana walnut seed populations tested.

Black Walnut Seed Sources	Timber Quality of Mother trees	Type of Location	Approximate # of Trees in Population	County	Field Color Code
Vallonia Subline 1	Excellent*	Seed Orchard	30	Jackson	Orange
Martell Clone Bank 1	Excellent*	Clone Bank	5	Tippecanoe	Yellow
Seymour Woods	Excellent	Forest	100	Jackson	Red
Seymour Home	Above average	Yard	75	Jackson	White
State School	Average	Yard	14	Jennings	Blue
SEPAC Plantation	Average	Plantation	20	Jennings	Green
Div. of Forestry Check	Unknown	Various	>300	State-wide	Pink
#226	Excellent*	Clone bank	1	Tippecanoe	—

* Grafted trees from ortets selected for excellent quality.

Data Collection and Analysis

Trees on each site were measured for height, diameter at breast height (DBH), and two timber quality traits 3, 5, 8, and 10 years after planting. Trees were rated as "1" having a single leader or "0" for those not having a clear single central leader. Timber form was rated on a 5-point subjective scale based upon a composite of straightness, apical dominance, self-pruning, lateral branch numbers, angles, and sizes, depressed knots, and crooks in the stem. Each value represents the following subjective quality rating: 1 = poor, 2 = below average, 3 = average, 4 = above average and 5 = excellent.

Improvement values were calculated by dividing population mean values for each trait, at each site, by the overall planting mean for the trait at that site, and then a total improvement value for each population was calculated by adding the values for height, DBH, single-leader, and stem-form quality, and dividing by four. Means for each trait were analyzed by one-way ANOVA using Microsoft Excel 2010. When ANOVAs were significant ($P \leq 0.05$), means were compared by least significant difference (Steel and Torrie 1980).

Results

Three years after planting, survival, height, and presence or absence of a single-leader differed significantly (data not shown). At Martinsville, survival averaged 84 percent overall with individual populations ranging from 72 to 91 percent. Survival averaged 98 percent

at Fishers, with populations ranging from 94 to 100 percent. The SEPAC population had the lowest survival at both sites. Tip-dieback and stem cankers affected 57 percent of seedlings across all populations at Martinsville compared to just 6 percent at Fishers. These diseases were primarily due to a large infestation of ambrosia beetles, particularly at Martinsville, in 2004. The stem cankers appeared to be a result of either *Fusarium* or *Phomopsis* fungi, both of which cause annual cankers on walnut, but no known pathogen was confirmed. By the fifth year, survival remained unchanged at either site but growth varied significantly between sites (data not shown). Trees were larger and more uniform at Fishers. Trees that had been affected by stem cankers at Martinsville had mostly recovered or re-sprouted from disease/insect problems encountered in years two and three. At Martinsville however, blocks planted on the Ava silt loam soil failed to thrive. Most of the half-sib family planted on this soil began to show signs of stress by five years.

By the tenth year, quality differences remained significantly different among populations (table 2) while height and DBH differences still present were no longer statistically significant. The half-sib family performed very well at Fishers and had remarkable consistency in growth indicated by the low standard deviations for height and DBH. However, at Martinsville, on the Ava soil, the same family grew far below average. Under these poor growing conditions, the half-sib family still had good stem form although the percentage of trees with single leaders was greatly reduced. Figure 1 illustrates the range and variation in height distribution among the three most distinctly different populations and how the median height value shifts above or below the mean.

Table 2. Performance of 10-year old seedlings from eight different black walnut seed sources grown at two central Indiana sites.

Population	Site	Growth				Quality				Total Improvement ³ (%)
		Height (cm)	SD	DBH (mm)	SD	Single Leader ¹ (%)	SD	Stem Form ² (1-5)	SD	
Vallonia Subline ¹	Fishers	514	69	65	9	48 ^A	14	3.4 ^A	0.3	113
	Martinsville	478	138	47	15	42 ^a	13	3.1 ^a	0.4	121
Martell Clone Bank ¹	Fishers	502	41	66	4	47 ^A	13	3.5 ^A	0.2	113
	Martinsville	443	84	44	8	33 ^b	8	2.8 ^b	0.4	106
State School	Fishers	500	91	61	11	35 ^B	13	2.9 ^B	0.4	99
	Martinsville	488	110	49	12	25 ^{bc}	7	2.8 ^b	0.1	105
Seymour Home	Fishers	470	71	58	10	34 ^B	14	2.8 ^B	0.1	97
	Martinsville	404	30	42	4	20 ^c	10	2.4 ^{cd}	0.2	106
Seymour Woods	Fishers	462	104	56	12	41 ^{AB}	11	2.9 ^B	0.5	94
	Martinsville	455	72	45	9	35 ^{ab}	7	2.5 ^c	0.1	94
IN DoF Check	Fishers	450	47	56	6	33 ^B	9	2.9 ^B	0.3	92
	Martinsville	410	50	41	6	17 ^c	5	2.5 ^c	0.2	86
SEPAC Plantation	Fishers	442	101	57	14	33 ^B	4	2.7 ^B	0.3	91
	Martinsville	350	110	33	3	33 ^b	10	2.1 ^d	0.2	88
#226 Half-Sib Family ⁴	Fishers	572	26	70	5	47 ^A	3	3.6 ^A	0.1	119
	Martinsville ⁵	362	39	37	6	14 ^c	9	3.0 ^a	0.2	—

¹ Proportion of trees with a single leader at 10-years. Means followed by different letter are significantly different $P \leq 0.05$.

² Average quality rating: 1 = poor, 2 = below average, 3 = average, 4 = above average, 5 = excellent. Means followed by different letter are significantly different $P \leq 0.05$.

³ Sum of the mean for each growth and quality character, divided by four, weighing each character equally, to generate relative improvement value.

⁴ The half-sib family was planted adjacent to the seven 1-0 bare root seedling populations as five blocks of 80 trees.

⁵ At Martinsville, this family was planted on the Ava silt loam and not the Wilbur silt loam like the other 7 bulked populations.

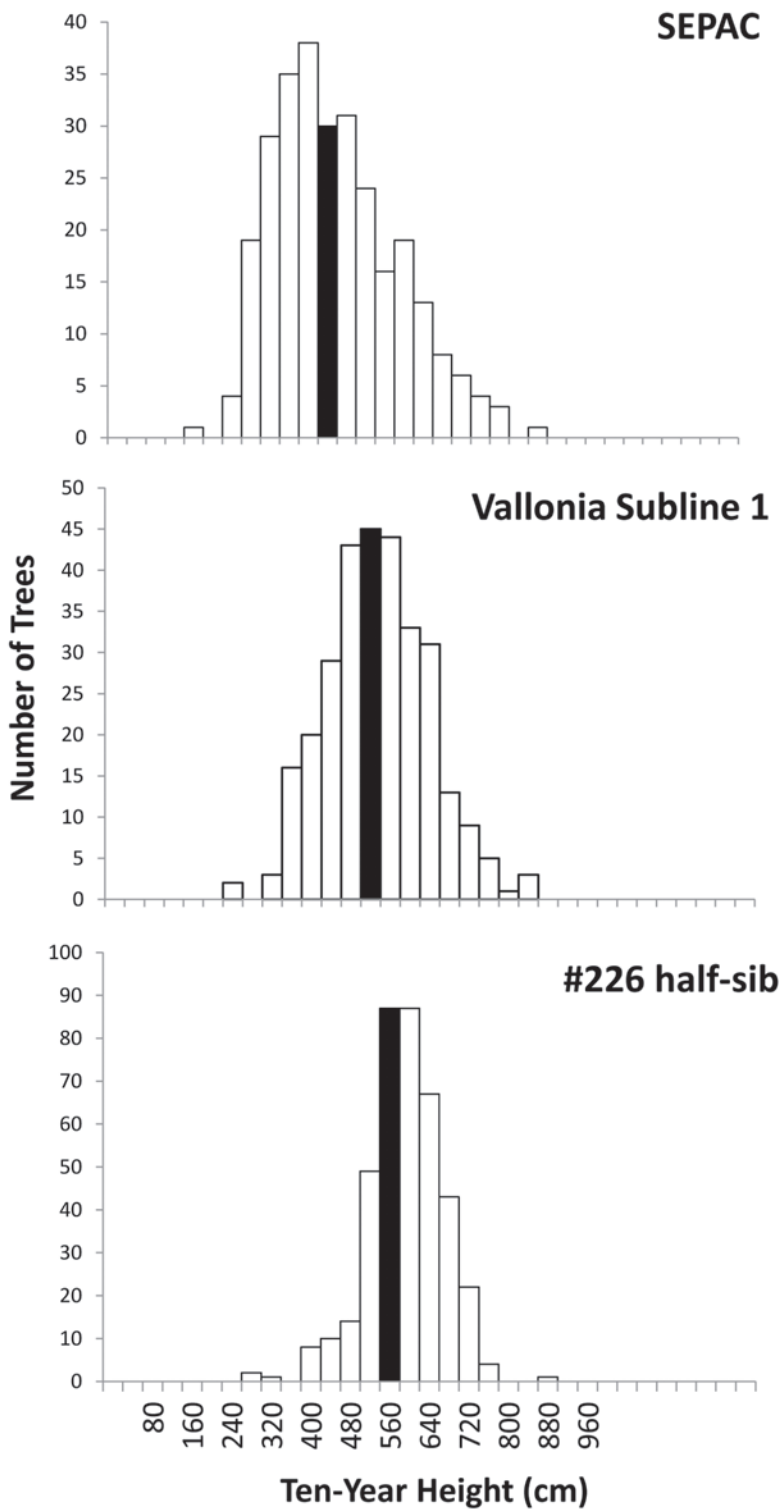

Figure 1. Height distribution of the three most distinctly different populations. (SEPAC) with a mean height of 439 cm (173 in) and a median value of 419 cm (165 in); (Vallonia Subline 1) with a mean height of 514 cm (202 in) and a median value of 511 cm (201 in); and the half-sib (#226) with a mean height of 572 cm (225 in) and a median value of 576 cm (227 in). Dark bars indicate each population mean. Data from the Fishers site only.

SEPAC

Trees rated as poor or below average in quality are candidates for early thinning, while trees rated as average or better can be retained as potential crop trees. Combining trees rated as poor and below average (quality ratings 1 and 2 out of 5) together into a “below average quality” class and comparing that value with the remaining trees rated as average, above average, or excellent (quality ratings 3, 4, and 5 out of 5) into an “average to above average quality” class, shows over 80-percent of the select Vallonia seedlings and half-sib seedlings rating as average or better compared to the poorest performing SEPAC population (figure 2). The other populations had more even distributions with values ranging between 45 to 55 percent below average and 55 to 45 percent average or better, compared to the three sources in figure 2.

Discussion

Both growth and quality traits of the walnut trees in this study varied greatly in the early years after planting. Age-to-age correlations studies in other species suggest that 8-16 years is necessary before meaningful early data can be obtained (Squillace and Gansel 1974; Lambeth 1980; Riemenschneider 1988). Rink and Kung (1995) found that eight year growth data was strongly correlated with 20-year growth data for black walnut. Indeed, in the present study, significant differences among populations in early growth disappeared by ten years. However, quality differences remained significant throughout the decade. Seedlings from the Purdue University clone bank, the Vallonia Subline 1 seed orchard, and from the half-sib family, all had significantly better stem quality than did the other five bulked populations throughout the study. Increasing the single leader percentage should minimize the need for pruning co-dominant leaders and increase the length of merchantable logs. Raising the stem quality rating should reduce the need and volume of corrective pruning along with elevating the timber-grade of trees, which ultimately will increase the timber value.

Beineke (1989) reported a 2% to 12% improvement in height and diameter from several previous walnut progeny tests, but does not indicate if the differences were statistically significant. Both the Vallonia orchard and Martell clone bank material showed height growth trending above the plantation mean, but the ANOVA was not significant ($P = 0.28$). We found a similar trend with stem diameter (DBH), consistent with Beineke’s values but again, by ten years, the differences were statistically insignificant suggesting that non-genetic factors have a large effect on walnut growth rates. It is not uncommon to find more genetic variation within populations than among them (Paul Bloese, personal communication 2013).

Walnut trees are not naturally apically dominant as they commonly grow with crooks and sweep, particularly when they grow vigorously. Selecting for improvement in both growth rate and stem quality simultaneously in walnut has proven difficult. While the general goal of walnut forest tree improvement is to develop bigger and better trees, there are biological constraints for breeding both simultaneously.

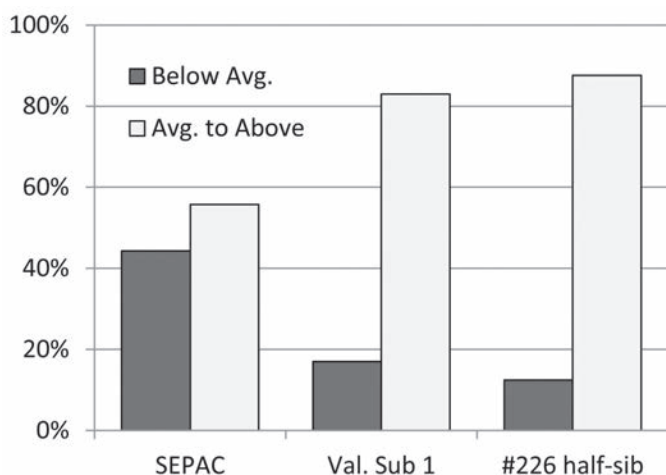

Figure 2. Proportion of 10-year-old trees rated below average or average to above average in quality of the three populations from figure 1. Below average trees scored a 1 or 2 stem-form rating at ten years and are candidates for early thinning. Average, above average, and excellent trees have a stem-form rating of 3, 4, or 5, respectively, and represent potential crop trees. Data from the Fishers site only.

For walnut, the two traits tend to oppose one another as a large vigorous walnut will often have bad form while smaller, slower growing walnut can have excellent form. Typical non-genetic factors that affect walnut growth include soil, hydraulic conditions (too wet or too dry), and neighboring competition (both above and below ground). Only by first growing walnut well on a good site, then analyzing numerous replicated genetic tests across many sites, can one accurately evaluate the genetic component of vigor in walnut selections.

The performance of the half-sib family between the two different sites in the current study is very dramatic and highlights this difficulty. While the half-sib had the highest overall improvement value at Fishers (+19 percent), it performed far below average at Martinsville. It was, however, inadvertently planted on a very poor soil at Martinsville, and as such is not directly comparable to the bulk populations grown there on the better soil. Clearly, utilizing too few test sites, and not controlling or accounting for soil differences within a given test site, can lead to erroneous conclusions on the genetic growth potential of walnut. This result underscores the extreme site sensitivity of walnut, and furthermore, the fact that genetically improved walnut will not show any gain when grown on an unsuitable walnut site. As we begin to make a second cycle selections from a broad series of progeny tests, we expect to be better able to select for vigor by selecting larger individuals grown in even-aged plantations that already have an improved level of genetic quality for timber form.

For the grower, a reduction in the number of slower growing and poorly formed trees, like the Vallonia Subline 1 and half-sib trees offer (figure 2), functionally improves the plantation. While improvement can be made culturally through pruning, staking, and fertilizing trees, such cultural management is costly and uncommon in forestry. Thus, having planting stock with genetic qualities for good timber form and uniform growth are very desirable. As better hardwood nursery stock and plantation management strategies have developed, today's landowners can achieve higher survival rates in new plantings. By utilizing select genetic stock that produces a higher percentage of acceptable trees, and grows more uniformly overall, pruning can be simplified and reduced, thinning decisions can become more systematic, and fewer walnut trees

need to be planted which can make mixed hardwood plantings more successful (McKenna and Farlee 2013).

Through progeny testing, tree improvement provides a means of weeding out poor performing seed sources as well as developing sources that will be bigger and better. Thus, source-identified and progeny-tested seed, given good site selection and management, provides a grower confidence that trees have the genetic capacity to grow well. The practical reality is that walnut seed for reforestation will only rarely ever come from forest stands. By creating grafted walnut seed orchards from wild plus-trees we are able to capture genotypes from the forest, and by planting them together in an orchard, seed production and harvesting can be more economically managed. As replicated progeny test data becomes available, poorer performing clones can be eliminated from the Vallonia orchard, thereby converting it into an improved walnut seed orchard.

Acknowledgments

The following individuals were instrumental in developing and executing this study: William Rodecker, Lee Eckart, Jack Siefert, Jewel Yeager, Charles Michler, Bob Hawkins, Rob Wink, Brian Beheler, and Don Carlson. Funding for this project was provided by the Fred M. van Eck Foundation, Hardwood Tree Improvement and Regeneration Center, Department of Forestry & Natural Resources, Purdue University, West Lafayette, IN.

References

- Bey CF. 1980. Growth gains from moving black walnut provenances northward. *Journal of Forestry*, 78(10), 640-645.
- Beineke WF. 1989. Twenty years of black walnut genetic improvement at Purdue University. *Northern Journal of Applied Forestry*, 6(2), 68-71.
- Bloese, P. 2013. Personal communication. East Lansing, MI: Tree Improvement Supervisor, Forestry Department, Michigan State University, 126 Natural Resources Building
- Bonner FT, Karrfalt RP. 2008. The woody plant seed manual. United States Department of Agriculture Forest Service Agriculture Handbook 727.
- Cassens DL. 2004. Manufacturing fine hardwood face veneers. FNR-240. Purdue University, West Lafayette, IN, 8.
- Funk DT. 1973. Genetics and tree improvement. In: *Black Walnut as a Crop*. Proceedings of the Black Walnut Symposium, Carbondale, IL, USDA Forest Service General Technical Report NC-4, North Central Forest Experiment Station, St. Paul, MN, 59 – 61.
- Hoover B. 1995. Predicting black walnut log prices. FNR 148. Purdue University and U.S. Department of Agriculture Cooperating, West Lafayette, IN. Web site only – accessed December 2013. <<http://www.extension.purdue.edu/extmedia/FNR/FNR-148.html>>.
- Lambeth CC. 1980. Juvenile-mature correlations in *Pinaceae* and implications for early selection. *Forest Science*, 26(4), 571-580.
- McGuire M, Stevens J, Potter-Witter K. 1999. Assessing scarcity of the north central veneer log resource. *Northern Journal of Applied Forestry*, 16(3): 160-166.
- McKenna JR, Farlee L. 2013. Designing and establishing a fine hardwood plantation. Proceedings of the Seventh Walnut Council Research Symposium. GTR-NRS-P-115, 48-67.
- Riemenschneider DE. 1988. Heritability, age-age correlations, and inferences regarding juvenile selection in Jack pine. *Forest Science* 34: 1076 – 1082.

- Rink G. 1984. Trends in genetic control of juvenile black walnut height growth. *Forest Science* 30: 821-827.
- Rink G, Kung FH. 1995. Age trends in the genetic control of *Juglans nigra* height growth. Gen. Tech. Rep. NE-197. USDA, Forest Service, Northeastern Forest Experiment Station, 247-255.
- Schmidt TL, and Kingsley NP. 1997. Status of black walnut in the United States. United States Department of Agriculture, Forest Service, General Technical report, North Central, No. 191: 9-22.
- Steel GD, Torrie JH. 1980. Principles and procedures of statistics, a biometrical approach. 2nd edition. McGraw-Hill, Inc.
- Victory E, Woeste K, and Rhodes OE. 2004. History of black walnut genetics research in North America. United States Department of Agriculture, Forest Service, General Technical report, North Central, No. 243, 1-14.
- Wallace DC, Young FJ. 2008. Black walnut suitability index: A natural resources conservation service national soil information system based interpretive model. Proceedings of the 16th Central Hardwoods Forest Conference, 589-595.

The Threat of Hybrid *Phytophthoras*

Janna Beckerman, Stephen Goodwin and Kevin Gibson

Janna Beckerman, Associate Professor, Department of Botany and Plant Pathology, Purdue University. West Lafayette, IN 47907; E-mail: jbeckerm@purdue.edu

Stephen Goodwin, Professor, Department of Botany and Plant Pathology, Purdue University. West Lafayette, IN 47907; E-mail: sgoodwin@purdue.edu

Kevin Gibson, Associate Professor, Department of Botany and Plant Pathology, Purdue University. West Lafayette, IN 47907; E-mail: kgibson@purdue.edu

Beckerman J, Goodwin S, Gibson K. 2014. The Threat of Hybrid *Phytophthoras*. In: Wilkinson KM, Haase DL, Pinto JR, technical coordinators. National Proceedings: Forest and Conservation Nursery Associations—2013. Fort Collins (CO): USDA Forest Service, Rocky Mountain Research Station. Proceedings RMRS-P-72. 12-17. Available at: http://www.fs.fed.us/rm/pubs/rmrs_p072.html

Abstract: The majority of invasive plant pathogens have resulted from the introduction of exotic organisms. However, another mechanism for invasiveness results from hybridization between species. This phenomenon has been documented in plants and animals, but its role in plant pathology has only recently been recognized. With more than 100 species of *Phytophthora* identified to date, and little information regarding their biogeography and native habitat, *Phytophthora* hybrids are difficult to detect. Unfortunately, recent taxonomic surveys for *Phytophthora* in the nursery, greenhouse and landscape have identified multiple hybrids involving different parental species. Their spread via the international plant trade poses significant risks to ecosystems throughout the world.

Key Words: hybrid plant pathogens, transgressive segregation, invasive plant pathogens

Introduction

Plant disease epidemics that result from the introduction of exotic organisms are well-recorded phenomena (Brasier 2008). First documented with chestnut blight, and later, Dutch elm disease, Jarrah decline, and sudden oak death (SOD), diseases caused by introduced plant pathogens have changed ecosystems. In the case of Jarrah decline and SOD, *Phytophthora* species were the causal agents. Unlike other plant disease epidemics, these two introduced *Phytophthora* species, *P. cinnamomi* and *P. ramorum*, have broad host ranges, and are capable of infecting hundreds of species of plants. Although the spread of *P. cinnamomi* began in colonial times by unknown means, the primary spread of *P. ramorum* was through the nursery industry (Frankel 2008).

Unlike true fungi, which are members of the Kingdom Fungi, *Phytophthora* species are members of the Kingdom Stramenopila, which includes everything from large 100-ft (30-m) seaweeds (phaeophytes or brown algae) to diatoms, golden algae, and water molds (Phylum: Oomycota). Members of the oomycota, often called oomycetes, are diploid (unlike most true fungi, which are haploid) and their cell walls contain cellulose, whereas those of true fungi are composed primarily of chitin. Oomycetes are fungus-like in that they produce hyphae to invade and colonize a plant, and possess a life cycle that includes a sexual and an asexual phase of spore production. *Phytophthora* species are either homothallic (self-fertile), having the ability to undergo sexual reproduction with only one individual, or heterothallic, meaning the species requires two mating types for sexual reproduction (meiosis and recombination), although homothallic isolates have been found in species previously identified as heterothallic and some homothallic species can outcross (Goodwin 1997). Regardless of whether reproduction is homothallic or heterothallic, the reproductive outcome is a thick-walled, sexual spore called an oospore, which functions not only as a means to recombine genetic material, but also as a structure that can survive adverse environmental conditions.

Phytophthora reproduction also can occur asexually through the production of sporangia that can germinate directly or develop and release multiple, motile zoospores that are capable of swimming to a potential host and forming a cyst that germinates and then penetrates host tissue. Additionally, chlamydospores can be formed, which are asexual overwintering structures that are able to persist through mildly adverse environmental conditions better than sporangia, but not as well as oospores. These multiple (and elastic) reproductive strategies allow *Phytophthora* species to adapt readily to their environments. As a result of this genetic elasticity, plant pathogens like *Phytophthora* are notorious for their ability to quickly evolve fungicide resistance (Goodwin and others 1996) and overcome host plant resistance to exploit new opportunities (Fry 1982). For example, new races of potato late blight (caused by *P. infestans*) quickly destroyed single major resistance genes in potato (Fry 1982) and widespread resistance to metalaxyl has rendered the fungicide ineffective in commercial control of late blight (Goodwin and others 1996).

The multiple reproductive strategies of *Phytophthora* species may partially explain their success as important plant pathogens of agricultural and ecological systems and can account for significant losses due to root rots, crown rots, leaf blights, cankers, and stem dieback (Leonberger and others 2013; Erwin and Ribeiro 1996). Although many *Phytophthora* species have limited host ranges, similar to what is seen for the causal organisms of chestnut blight and Dutch elm disease, other *Phytophthora* species have a very broad host range that includes a diversity of host plants. These host plants often grow in proximity to each other in nurseries, greenhouses (Leonberger and others 2013), and later, in the landscape and forest ecosystem (Hansen and others 2012; Frankel 2008; Rizzo and others 2002; Zentmeyer 1983).

This diversity of hosts is mirrored in species diversity of the genus *Phytophthora*, which currently includes more than 100 described members capable of infecting more than 1000 plant hosts, causing significant economic and ecological losses around the world (Kroon and others 2012; Erwin and Ribeiro 1996). Historically, the identification of *Phytophthora* species was based on morphology. Waterhouse (1963) developed a key that divided the genus into six groups, based on host range, sporangium types, antheridium and oogonium morphology, chlamydospore production, observation of hyphal swellings, optimal growth temperature, and colony morphology. Many of these characters are not produced consistently and can be very variable in nature and in culture. It is not surprising, therefore, that *Phytophthora* isolates in culture are difficult to identify to species based solely upon morphology. This difficulty was acknowledged early on, and it was suggested that naturally occurring interspecific hybrids of *Phytophthora*, if they even existed, would be difficult to identify (Brasier 1991). However, during the last decade, recent advances in molecular techniques and their incorporation into molecular taxonomy have resulted in a dramatic expansion of the genus *Phytophthora*, with the number of recognized species nearly doubled, and new species and hybrid species identified regularly (Cooke and others 2000; Kroon and others 2004; Martin and Tooley 2003; Man in't Veld and others 2012). This explosive increase in *Phytophthora* species identification is due primarily to the application of molecular tools to taxonomy, which has provided greater resolution and an improved understanding of the species concept in this genus (Hansen and others 2012; Kroon 2010). In addition to identifying new species, these molecular techniques have also proven the putative hybrid nature of atypical strains (Brasier and others 1999; Brasier and others 2004).

Although most fungi occupy relatively limited geographic ranges (Ellison and others 2011; Giraud and others 2010), they may have the potential to occupy much larger ranges if dispersal barriers are overcome (Springer and Chaturvedi 2010), as they are via nursery

trade. The dispersal of pathogenic fungi by humans has been linked to the migration of humans with their plants and animals, and to the global trade in food and other products (Stuckenbrock and others 2008; Brasier 2008). Thus the potential for the rapid evolution and spread of pathogenic species appears to be substantial, posing serious threats to wild plant and animal species, to food security, and to ecosystem health (Fisher and others 2012). However, the expansion of geographic ranges may be only the beginning of large-scale plant disease epidemics (epiphytotics). The recent identification of new *Phytophthora* species in the nursery industry (De Cock and Levesque 2004) has been followed by the identification of hybrids (Bonants and others 2000) and further dissemination of these new *Phytophthora* hybrids via the nursery trade (Man in't Veld and others 2007). For example, the hybrid *P. nicotianae* X *cactorum* was first identified in the Netherlands, but now has been found throughout Europe, Hungary, Peru, Taiwan (Érsek and Man in't Veld 2013) and in the US (Leonberger and others 2013). The discovery of widespread *Phytophthora* hybrids has brought about a recognition that the introduction of exotic species is not the only contributor to epiphytotics.

Rise of the Hybrid *Phytophthoras*

A hybrid refers to an offspring that is the result of breeding between two different species: A cross between a horse and a donkey results in a hybrid called a mule; a cross between European honeybees and African bees resulted in the 'killer bees.' In plants, hybrids are regularly developed to improve specific characteristics in the resulting seeds, and to protect against deleterious characteristics due to the likelihood of different alleles (heterozygosity) at a given gene or locus. Between species, reproductive barriers exist to prevent hybridization from occurring regularly, as it would most likely result in the wasting of gametes by producing unadapted offspring. These barriers are usually stronger when the species occur in the same geographic area and regularly encounter another (sympatry) than when the species have evolved in isolation (allopatry). Historically, and in the context of animal evolutionary biology, interspecific hybridization, at least in nature, is a rare event, but see work in plants (Riesenberg and others 2003) and fungi (Frey and others 1999; Newcombe and others 2000) for exceptions. In *Phytophthora*, an organism known for its genetic elasticity, population studies in greenhouses found only two species of *Phytophthora* contributing to the disease outbreaks in the affected greenhouses, and that asexual reproduction of the pathogens drove the epidemics (Lamour and others 2003), highlighting the rarity of hybridization.

Despite its relative rarity, interspecific hybridization has been proposed as a key mechanism in the evolution of invasive species (Ellstrand and Schierenbeck 2000; Schierenbeck and Ellstrand 2009). The rapid evolutionary change that results from hybridization has an obvious and important role in the process in biological invasions (Prentis and others 2008). Schierenbeck and Ellstrand (2009) reported 35 examples in 16 plant families in which invasiveness followed interspecific hybridization. Multiple introductions of a non-native species, particularly from a wide geographic range, may also create opportunities for rapid evolutionary change through interspecific hybridization (Schierenbeck and Ellstrand 2009). There is no reason to think this cannot happen with *Phytophthora*, and considerable evidence suggests, at least in the case of alder decline, that it already has (Brasier and others 2004). A hybrid ultimately described as *P. alni*, first detected on dying alders and associated with 10-15% mortality of alders in Great Britain, has spread throughout Europe. Originally thought to be a hybrid of *P. cambivora* and a *P. fragariae*-like species (Brasier and others 1999), the original

hybridization event itself is open to conjecture; but agreement exists that the event was recent, and that *P. alni* arrived in Britain on infected nursery stock. It is unknown how this hybrid arrived in Alaska, and it continues to be a threat to alder species, and other *Phytophthora*-susceptible trees (Brasier and others 2004).

In 1998, an unknown *Phytophthora* isolate was recovered from diseased ornamentals in the genera *Spathiphyllum* and *Primula* grown hydroponically in the Netherlands (Man in 't Veld and others 1998). These isolates were described as natural hybrids between *P. nicotianae* and *P. cactorum* (Man in 't Veld and others 1998). In 2000, additional atypical *Phytophthora* isolates were recovered on different hosts. DNA fingerprinting demonstrated that these isolates were also *P. nicotianae* x *P. cactorum* hybrids and that they likely had emerged through different hybridization events (Bonants and others 2000). Continuous hydroponic systems with multiple crops provide an ideal environment for *Phytophthora* species to co-exist on a variety of different hosts where they may eventually be able to hybridize (Bonants and others 2000). Other *P. nicotianae* x *P. cactorum* hybrids have been found on loquat (*Eriobotrya japonica*) in Taiwan and Peru, but with genetically distinct isolates (Chern and others 1998; Hurtado Gonzales and others 2009).

Many currently identified hybrids have resulted from interspecific hybridization within clades of closely related species (Kroon and others 2010). *P. nicotianae* and *P. cactorum* are closely related species (Cooke and others 2000), as are *P. hedraiaandra* and *P. cactorum* (Kroon and others 2010). This suggests that the evolution of some *Phytophthora* hybrids may have been possible because the two parent species have not diverged to a point where they are incompatible (Man in 't Veld and others 1998). To date, most *Phytophthora* hybridizations that have been identified appeared to have occurred between species that evolved allopatrically in different geographical locations, involving an exotic and native species, or two exotic species that occupied the same niche (Érsek and Man in 't Veld 2013).

Hybrid *Phytophthoras* and Transgressive Segregation

Within any group of organisms, and especially within the genus *Phytophthora*, extraordinary variation exists, and multiple mechanisms are in place to ensure the organism's persistence. Within the field of ecology, two highly polarized viewpoints exist: Hybridization serves as "a potent evolutionary force that creates opportunities for adaptive evolution and speciation and provides increased genetic variation and new gene combinations that promote the development and acquisition of novel adaptations"; or hybridization contributes little in evolutionary terms (aside from allopolyploidy), serving as a primarily local phenomenon with only transient effects (Riesenberg and others 2003, p. 1).

Within the laboratory, synthetic hybridization experiments have been undertaken to examine the likelihood and outcome of such hybrids in plants (Riesenberg and others 2003), and in *Phytophthora* species (Érsek and others 1995; Goodwin and Fry 1994). In some instances, the resulting hybrid has had a modification of host range, with a loss of pathogenicity as compared to the parental isolates, or an additive effect where the hybrid had the ability to infect hosts of both parents, which did not have an overlapping host range (Érsek and others 1995; Goodwin and Fry 1994). Goodwin and Fry (1994) crossed the closely related *P. infestans* and *P. mirabilis*; both have limited host ranges. These two sympatric *Phytophthora* species have similar morphology, growth characteristics in culture and in planta, and high degree of

genome homology (Kroon 2010). Most of the hybrids lost the ability to infect the hosts that were infected by the parents. However, a recent cross between an isolate of *P. infestans* virulent on potato and tomato (Solanaceae) and a *P. mirabilis* isolate virulent on the ornamental plant four o'clock flower (*Mirabilis jalapa*) (Nyctaginaceae) produced F1 and F2 progeny that were pathogenic on tomato, including one F2 isolate that was capable of infecting all parental hosts (Kroon 2010). Érsek and others (1995) created interspecific hybrids between *P. capsici* and *P. nicotianae* by zoospore fusion and found hybrids could infect either all previous parental host species (2/3), or none (1/3).

Although many hybrids are not viable, large phenotypic changes are possible. These changes can drive range expansion, host jumping in the case of pathogens, and increased virulence (Mallett 2007). Studies of quantitative traits in segregating hybrid populations often report phenotypes that are extreme or novel relative to those of either parental line (Goodwin and Fry 1994; Riesenberg and others 2003; Stuckenbrock and others 2012). These extreme or novel phenotypes are described as transgressive segregants (Riesenberg and others 1999) and may exhibit traits (dispersal, resource acquisition, stress tolerance) that allow them to overcome biotic and abiotic obstacles that constrained the parental lines. Thus, transgressive segregation can contribute to invasiveness. This was demonstrated with hybrid *Phytophthora* isolates from alders in the UK (Brasier and Kirk 2001). The parents of the hybrids are believed to be *P. cambivora* and *P. fragariae*, neither of which is a strong pathogen of alder. However, the hybrids are highly pathogenic to alder so have an altered host range compared to either parent.

Transgressive segregation is an important process for generating novel traits that are heritable in both agricultural and native environments. *Phytophthora* species provide almost a model system for studying these mechanisms, due to the ability of the genus to tolerate different numbers and combinations of chromosomes, with triploids, tetraploids and many aneuploid types with odd numbers of chromosomes known (Goodwin 1997). The genomic plasticity of *Phytophthora* provides the genetic playground necessary to avoid potentially deleterious mutations. This plasticity also shelters the genetic material for transgressive segregation that can result in stable, hybrid isolates with traits that are very different from either parent (Kroon 2010; Érsek and others 1995).

Transgressive segregation is one means of explaining the expansion of host range observed with the *P. cactorum* x *hedraiaandra* isolates in the US. Originally reported on *Rhododendron*, and later *Viburnum*, in Europe (Man in 't Veld and others 2012) and the US (Leonberger and others 2013), an isolate of this hybrid was found on bleeding heart (*Dicentra*) in a nursery, a host that had not been reported for either parental species. Koch's postulates were performed to confirm that the hybrid could infect the original *Dicentra* cultivar 'Luxuriant.' Since the parental species were not able to infect the *Dicentra* host, an expansion of host range through hybridization was proposed (Leonberger 2010). Subsequent studies found that the hybrid isolate could infect additional species of native bleeding hearts, including wild bleeding heart (*D. eximia*), squirrel-corn (*D. canadensis*), and Dutchman's breeches (*D. culcullaria*) (Beckerman and Gerberich, unpublished). It has been hypothesized that *Phytophthora* hybrids often arise as offspring of two exotic species or of an exotic and resident species (Man in 't Veld and others 2007; Érsek and Nagy 2008). In this instance, an exotic and native *Phytophthora* were the putative parental species, and yet the offspring exhibited broader host ranges than either parent (transgressive segregation), resulting in new host range specialization and increased pathogenicity and virulence (Brasier 1995).

The Rhododendron as a Hybrid Zone

A hybrid zone is a location where species or interspecific lines come together, mate, and produce hybrid offspring (Barton and Hewitt 1989). Hybrid zones that arise from the mingling of species or intraspecific lines that were previously isolated geographically may play an important role in invasions. Hybrid zones might also arise as a consequence of habitat disturbance and/or environmental change, and hybrids can certainly be found in disturbed habitats (Ellstrand and Schierenbeck 2000; Harrison 1993). However, we propose that nurseries, greenhouses, and landscaping can serve as hybrid zones for *Phytophthora* by placing hosts for native and introduced species in close proximity. The spread of *Phytophthora* species between production facilities via plant movement has been documented (Lamour and others 2003) and is understood to be a means of invasion (Rizzo and others 2002; Brasier and others 2001) for the pathogen. More specifically, we suggest that widely planted species like *Rhododendron* may themselves serve as hybrid zones. *Rhododendron* species (including azaleas, which belong to the genus *Rhododendron*), hybrids, and cultivars are popular and widely planted ornamentals. Within the nursery industry, rhododendron is recognized as being regularly infected by a number of *Phytophthora* species known to cause root rot (*P. cactorum*, *P. cinnamomi*, *P. citricola*, *P. citrophthora*, *P. cryptogea*, *P. drechleri*, *P. gonapodyides*, and *P. megasperma*), shoot blight (*P. cactorum*, *P. citricola*, *P. citrophthora*, *P. hedriandra*, *P. cactorum x hedriandra*, *P. nicotiana*, *P. cactorum X nicotiana*, *P. ramorum*, *P. syringae*), leaf spot (*P. syringae*) and damping off of seedlings (*P. cactorum*, *P. cinnamomi*, and *P. cryptogea*) (Hoitink and Schmitthenner 1974; Benson and Jones 1979; Erwin & Ribeiro 1996; Werres 2000; Farr and others 1996). In several *Phytophthora* surveys, rhododendron is commonly found as the host genus supporting the greatest number of isolates and diversity of *Phytophthora* species (Leonberger and others 2013; Yakabe and others 2009, Schwingle and Blanchette 2008).

Riesenberg and others (2003) found that hybridization can play an important role in adaptive evolution, but only if fit hybrid genotypes can escape from “the mass of unfit recombinants” in a hybrid population. A host plant like Rhododendron can serve as a hybrid zone because it supports the growth of multiple *Phytophthora* species without restriction. This lack of selection is necessary for hybridization to occur, for the establishment of hybrid offspring, and subsequent genotype fixations that are required for new, hybrid populations to evolve. Thus, *Rhododendron* species (and others like *Viburnum* and *Pieris*) serve as a hybrid zone, bridge, and Trojan horse of *Phytophthora* to the landscape, and are in and of themselves, a critical control point in need of better management (Parke and Grunwald 2012).

One aspect that drives the success (and the concerns about) fungal hybridization is that many fungal pathogens undergo recurrent cycles of asexual reproduction after intermittent sexual cycles. Thus, the establishment of hybrid species is facilitated by the multiple cycles of asexual reproduction in a saprophytic stage that provide inoculum build-up prior to selection for pathogenicity. The mixture of sexual and asexual reproduction present in many plant pathogens, and especially *Phytophthora* species, may facilitate the creation of new genetic combinations and the rapid amplification prior to and after successful infection of a new host.

Management to Minimize *Phytophthora*

There are several practices that can be taken to minimize the introduction, establishment, spread and potential hybridization of *Phytophthora* in the nursery. These practices are conceptually simple, but may be difficult to implement. First, nursery owners should know the source of their material and whether common sanitation practices are followed. Nursery owners should recognize that some plants are more susceptible to *Phytophthora* and require greater care. In the forest nursery, these highly susceptible plants include *Fagus*, *Juglans*, *Malus*, *Quercus*, and many conifers, including but not limited to *Abies*, *Chamaecyparis*, *Picea*, *Pinus*, *Thuja*, and *Tsuga*. Many native understory shrubs are even more susceptible than trees, especially *Ilex*, *Kalmia*, *Pieris*, *Rhododendron*, and *Viburnum*. This is especially important with *Rhododendron* and *Kalmia* species, which are extremely susceptible to and can tolerate infection from multiple *Phytophthora* species. Second, new plants should be placed under temporary quarantine in a separate area from regular stock. It is critical to NOT treat them with fungicides effective against *Phytophthora* during the quarantine stage; fungicides suppress and delay symptom development, but will not ‘cure’ infected plants. Using fungicides at this stage will mask symptoms and allow infected plants to remain in the nursery instead of being culled. Instead, nursery owners should observe the quarantined plants for several weeks, and dispose of any plants showing symptoms of disease by burning (do not compost). Third, containers should never be placed directly on soil where *Phytophthora* may be present; *Phytophthora* can readily move from the soil and any debris onto plants. Ideally, nursery ground should be sloped or well draining with 3 to 4 in (7.5 to 10 cm) of coarse gravel or rock between the soil and containers. This step raises containers from the ground, preventing infection from any soil-borne *Phytophthora*, and ensures good drainage at the site, to prevent waterlogged soil and standing water. Drainage tile, or a five-percent slope from gravel, can provide sufficient drainage to further prevent water from puddling. Ideally, slopes and tile should drain to irrigation channels that release water to a central holding pond. Water in this pond should be treated as containing *Phytophthora*, and subject to water treatment to minimize the amount of *Phytophthora*. Effective methods of treatment include chlorination, copper/silver ionization, slow sand filtration and ultra-violet radiation.

Finally, weeds, sick plants, or debris that can harbor pathogens or pests in the nursery and planting beds should be removed. Tools should be cleaned and sterilized regularly, as well as benches. If pots are being recycled, be sure to sterilize them between crops. Pots need to be well scrubbed and disinfected. Ideally, disinfection can be done with aerated steam via an autoclave; alternatively, use of a commercial disinfectant, which contains both antimicrobials and detergents (the detergent breaks down the cell wall to allow the disinfectant to better penetrate) for effective sterilization, is recommended. Any step that minimizes the likelihood of *Phytophthora* establishment minimizes the possibility of hybridization between species.

The High Price of Free Trade

The introduction of exotic invasives, including plant pathogens, is an under-recognized ecological problem caused by the globalization of commerce. Plant imports in the US increased 33% per decade over the past 43 years, and the importation of live plants is the most common pathway for the introduction of non-native plant pathogens, which costs US taxpayers billions of dollars annually (Liebhold and others 2012; Aukema and others 2011; Pimentel and others 2005). However, once here, the problem can extend beyond the scope of the primary introduction due to hybridization events, creating new pathogen diversity, and new hosts. Hybridization has already been recognized as a mechanism for invasiveness in plants (Schierenbeck and Ellstrand 2009), and in *Phytophthora* species (Brasier and others 2001). Regulatory programs on a national and international scale need resources to monitor and restrict “the predictable pathways by which pathogens move” (Hansen 2008 p. 40) and recognize those genera, like *Rhododendron*, *Pieris* and *Viburnum*, which serve as either reservoirs or even Trojan horses that promote pathogen spread and hybridization, and monitor these hosts more closely to minimize risk.

References

- Aukema J, Leung B, Kovacs K, and others 2011. Economic impacts of non-native forest insects in the United States. *PLoS ONE* 6: e24587.
- Barton NH, Hewitt, GM. 1989. Adaptation, speciation and hybrid zones. *Nature* 341: 497-502
- Benson DM, Jones RK. 1979. Etiology of Rhododendron dieback caused by four species of *Phytophthora*. *Plant Disease* 64:687-691.
- Bonants PJM, Hagenaar-de Weerd M, Man in 't Veld WA, Baayen RP. 2000. Molecular characterization of natural hybrids of *Phytophthora nicotianae* and *P. cactorum*. *Phytopath.* 90:867-874.
- Brasier CM. 2008. The biosecurity threat to the UK and global environment from international trade in plants. *Plant Pathol.* 57: 792–808.
- Brasier CM, Kirk SA, Delcan, J., Cooke, D. E. L., Jung, T., and Man in 't Veld, W. A. 2004. *Phytophthora alni* sp. nov. and its variants: Designation of emerging heteroploid hybrid pathogens spreading on *Alnus* trees. *Mycol. Res.* 108:1172-1184.
- Brasier CM, Kirk SA. 2001. Comparative aggressiveness of standard and variant hybrid alder phytophthoras, *Phytophthora cambivora* and other *Phytophthora* species on bark of *Alnus*, *Quercus* and other woody hosts. *Plant Pathology* 50: 218-229.
- Brasier CM, Cooke, DEL, Duncan JM. 1999. Origin of a new *Phytophthora* pathogen through interspecific hybridization. *Proc. Natl. Acad. Sci. USA* 96:5878-5883.
- Brasier CM. 1995. Episodic selection as a force in fungal microevolution, with special reference to clonal speciation and hybrid introgression. *Can. J. Bot.* 73:1213–1221.
- Brasier CM. 1991. Current questions in *Phytophthora* systematics: The role of the population approach. In *Phytophthora* (J. A. Lucas, R. C. Shattock, D. S. Shaw, and L. R. Cooke, Eds.), pp. 104–128. Cambridge Univ. Press, Cambridge.
- Chern LL, Ann PJ, Young HR. 1998. Root and foot rot of loquat in Taiwan caused by *Phytophthora*. *Plant Dis.* 82: 651–656.
- Cooke DEL, Drenth A, Duncan JM, Wagels G, Brasier CM. 2000. A molecular phylogeny of *Phytophthora* and related Oomycetes. *Fungal Genet. Biol.* 30:17–32,
- De Cock AWAM, Lévesque A. 2004. New species of Pythium And *Phytophthora*. *Studies in Mycology* 50, 481–7.
- Ellison CE, Hall C, Kowbel D, and others 2011. Population genomics and local adaptation in wild isolates of a model microbial eukaryote. *Proc. Natl. Acad. Sci. USA* 108: 2831–2836.
- Ellstrand NC, Schierenbeck K. 2000. Hybridization as a stimulus for the evolution of invasiveness in plants? *Proc. Natl. Acad. Sci. USA* 97:7043-7050.
- Érsek T, Man in't Veld WA. 2013. *Phytophthora* species hybrids: A novel threat to crops and natural ecostems. In *Phytophthora*, A Global Perspective. Lamour, K. Editor.
- Érsek T, Nagy ZÁ. 2008. Species hybrids in the genus *Phytophthora* with emphasis on the alder pathogen *Phytophthora alni*: a review. *Eur. J. of Plant Pathol.*, 122, 31–39.
- Érsek T, English JT, Schoelz JE. 1995. Creation of species hybrids of *Phytophthora* with modified host range by zoospore fusion. *Phytopath.* 85:1343-1347.
- Erwin DC, Ribeiro OK. 1996. *Phytophthora* Diseases Worldwide. St. Paul, MN: APS Press. 562 pp.
- Farr DF, Rossman AY. Fungal Databases, Systematic Mycology and Microbiology Laboratory, ARS, USDA. Retrieved October 31 2013, from <http://nt.ars-grin.gov/fungaldatabases/> and 1996 print edition.
- Fisher MC, Henk DA, Briggs CJ, Brownstein JS, Madoff LC, McGraw SL, Gurr SJ. 2012. Emerging fungal threats to animal, plant, and ecosystem health. *Nature* 484:186-194.
- Frankel SJ. 2008. Sudden oak death and *Phytophthora ramorum* in the USA: a management challenge. *Australasian Plant Pathology* 37:19–25.
- Frey P, Gatineau M, Martin F, Pinon J. 1999. Molecular studies of the poplar rust *Melampsora medusae-populina*, an interspecific hybrid between *M. larici-populina* and *M. medusae*. Page 34 in Proceedings of the International Poplar Symposium III; September 13–17 1999; Orleans (France).
- Fry WE. 1982. Principles of Plant Disease Management. Academic Press, NY. 378 p.
- Giraud T, Gladioux P, Gavrillets S. 2010. Linking the emergence of fungal plant diseases with ecological speciation. *Trends Ecol. Evol.* 25: 387–395.
- Goodwin SB. 1997. The population genetics of *Phytophthora*. *Phytopath.* 87: 462–473.
- Goodwin SB, Fry WE. 1994. Genetic analyses of interspecific hybrids between *Phytophthora infestans* and *Phytophthora mirabilis*. *Exp. Mycol.* 18: 20-32.
- Goodwin SB, Sujkowski LS, Fry WE 1996. Widespread distribution and probable origin of resistance to metalaxyl in clonal genotypes of *Phytophthora infestans* in the United States and western Canada. *Phytopath.* 86:793-800.
- Hansen EM. 2008. Alien forest pathogens: *Phytophthora* species are changing world forests. *Boreal Environment Research* 13:33-41.
- Hansen EM, Reeser, P.W., and Sutton, W. 2012. *Phytophthora* beyond agriculture. *Annu. Rev. Phytopathol.* 2012.50:359-378
- Harrison RG. 1993. Hybrids and Hybrid zones: Historical Perspective. In: *Hybrid Zones and the Evolutionary Process*. Oxford University Press. Pp 3-12.
- Hoitink HAJ, Schmitthenner AF. 1974. Relative prevalence and virulence of *Phytophthora* species involved in Rhododendron root rot. *Phytopath.* 64: 1371-1374.
- Hurtado-Gonzales OP, Aragon-Caballero LM, Flores-Torres JG, Man in 't Veld WA, Lamour KH. 2009. Molecular comparison of natural hybrids of *Phytophthora nicotianae* and *P. cactorum* infecting loquat trees in Peru and Taiwan. *Mycologia*
- Kroon LPNM, Brouwer H, de Cock, AWAM, Govers F. 2012. The genus *Phytophthora* anno 2012. *Phytopat.* 102:348-364.

- Kroon, LPNM. 2010. The genus *Phytophthora*; phylogeny, speciation and host specificity. Thesis, Wageningen University, Wageningen, NL. ISBN 978-90-8585-668-9.
- Kroon LPNM, Bakker FT, van den Bosch GBM, Bonants PJM, Flier WG. 2004. Phylogenetic analysis of *Phytophthora* species based on mitochondrial and nuclear sequences. *Fung. Genet. Biol.* 41:766-82.
- Lamour KH, Daughtrey ML, Benson DM, Hwang J, Hausbeck MK. 2003. Etiology of *Phytophthora drechsleri* and *P. nicotianae* (= *P. parasitica*) diseases affecting floriculture crops. *Plant Dis.* 87: 854-858.
- Leonberger AC, Speers Ruhl G, Creswell T, Beckerman JL. 2013. A Survey of *Phytophthora* spp. in Midwest Nurseries, Greenhouses, and Landscapes. *Plant Dis.* 97:63-40.
- Leonberger AJ. 2010. Distribution and host specificity of *Phytophthora* species found in Indiana nurseries, greenhouses, and landscape plantings. M.S. Thesis, Purdue University, West Lafayette, IN. <http://docs.lib.purdue.edu/dissertations/AAI1490674/>
- Liebold AM, Brockerhoff EG, Garrett LJ, Parke JL, Britten KO. 2012. Live plant imports: the major pathway for forest insect and pathogen invasions of the US. *Front Ecol. Environ.* 10: 135-143
- Mallet J. 2007. Hybrid speciation. *Nature* 446:279-283.
- Man in 't Veld WA, de Cock AWAM, Summerbell RC. 2007. Natural hybrids of resident and introduced *Phytophthora* species proliferating on new hosts. *Eur. J. Plant Pathol.* 117:25-33.
- Man in 't Veld WA, Rosenthal CHM, Hong C. 2012. *Phytophthora x serendipita* sp. nov. and *P. x pelgrandis*, two destructive pathogens generated by natural hybridization. *Mycologia* 104: 1390-6.
- Man in 't Veld WA, Veenbaas-Rijk WJ, Ilieva E, de Cock AWAM, Bonants PJM, Pieters R. 1998. Natural hybrids of *Phytophthora nicotianae* and *P. cactorum* demonstrated by isozyme analysis and random amplified polymorphic DNA. *Phytopath.* 88:922-929..
- Martin FN, Tooley PW. 2003. Phylogenetic relationships among *Phytophthora* species inferred from sequence analysis of mitochondrially encoded cytochrome oxidase I and II genes. *Mycologia* 95: 269-284.
- Newcombe G, Stirling B, McDonald S, Bradshaw JR. 2000. *Melampsora x columbiana*, a natural hybrid of *M. medusae* and *M. occidentalis*. *Myc. Res.* 104: 261-274.
- Parke JL, Grünwald NJ. 2012. A systems approach for management of pests and pathogens of nursery crops. *Plant Dis.* 96:1236-1244.
- Pimentel D, Zuniga R, Morrison D. 2005. Update on the environmental and economic costs associated with alien-invasive species in the United States. *Ecol. Econ.* 52: 273-88.
- Prentis PJ, Wilson JRU, Dormontt EE, Richardson DM, Lowe AJ (2008) Adaptive evolution in invasive species. *Trends in Plant Science* 13: 288-294.
- Riesenberg LH, Raymond O, Rosenthal DM, Lai Z., Livingstone K., Nakazato T, Durphy JL, Schwarzbach AE, Donovan LA, and Lexer C. 2003. Major ecological transitions in annual sunflowers facilitated by hybridization. *Science* 301:1211-1216.
- Riesenberg LH, Archer MA, Wayne RK. 1999. Transgressive segregation, adaptation, and speciation. *Heredity* 83:363-372.
- Rizzo DM, Garbelotto M, Davidson JM, Slaughter GW, Koike ST. 2002. *Phytophthora ramorum* as the cause of extensive mortality of *Quercus* spp. and *Lithocarpus densiflorus* in California. *Plant Dis.* 86:205-214.
- Schierenbeck KA, Ellstrand NC. 2009. Hybridization and the evolution of invasiveness in plants and other organisms. *Biological Invasions* 11: 1093-1105
- Schwingle BW, Blanchette RA. 2008. Host range investigations of new, undescribed, and common *Phytophthora* spp. isolated from ornamental nurseries in Minnesota. *Plant Dis.* 92:642-647.
- Springer DJ, Chaturvedi V. 2010. Projecting global occurrence of *Cryptococcus gattii*. *Emerg. Infect. Dis.* 16: 14-20.
- Stukenbrock EH, McDonald BA. 2008. The origins of plant pathogens in agroecosystems. *Annu. Rev. Phytopathol.* 46: 75-100.
- Stukenbrock EH, Christiansen FB, Hansen TT, Duteil JY, Shierup MH. 2012. Fusion of two divergent fungal individuals led the recent emergence of a unique widespread pathogen species. *Proc. Natl. Acad. Sci. (USA)* 109:10954-10959
- Waterhouse GM. 1963. Key to the species of *Phytophthora* de Bary. *Mycology Paper* No. 92, 22 pp. CMI Kew, UK.
- Werres S, Marwitz R, Man in 't Veld WA, De Cock AWAM, Bonants PJM, DeWeerd M, Themann K, Ilieva E, and Baayen RP. 2001. *Phytophthora ramorum* sp. nov., a new pathogen on *Rhododendron* and *Viburnum*. *Mycol. Res.* 105:1155-1165.
- Yakabe, LE, Blomquist CL, Thomas SL, MacDonald JD. 2009. Identification and frequency of *Phytophthora* species associated with foliar diseases in California ornamental nurseries. *Plant Disease* 93:883-890.
- Zentmyer GA. 1983. The world of *Phytophthora*. In: *Phytophthora, its biology, taxonomy, ecology and pathology* (Ed. by Erwin, D.C.; Bartnicki-Garcia, S.; Tsao, P.H.), pp. 1-8. American Phytopathological Society, St. Paul, USA.

Joint Northeast and Southern Forest Nursery Conference, Lafayette, Indiana



Indiana's State Forester, Jack Seifert, attended the 2013 Northeastern forest and conservation nursery conference. Photo by Al Myatt.



Participants at the Northeastern Forest and Conservation Nursery meeting toured the Purdue Department of Forestry and Natural Resources farm, including plantings by the Hardwood Tree Improvement and Regeneration Center. Photos by Al Myatt.



Guillermo Parcillo gave a tour of ArborAmerica clonal plantings to participants at the Northeastern Forest and Conservation Nursery meeting. Photo by Al Myatt.



Bob Hawkins and staff hosted a tour and provided several demonstrations for all aspects of Indiana's state nursery, Vallonia Nursery for Participants at the Northeastern Forest and Conservation Nursery. Photos by Al Myatt.



Bob Karrfalt, Director of the National Seed Lab, gave a demonstration of DIY seed drying equipment during the field tour for the Northeastern Nursery meeting. Photo by Al Myatt.

Western Forestry and Conservation Nursery Association Meeting

Olympia, Washington

August 6 to 7, 2013

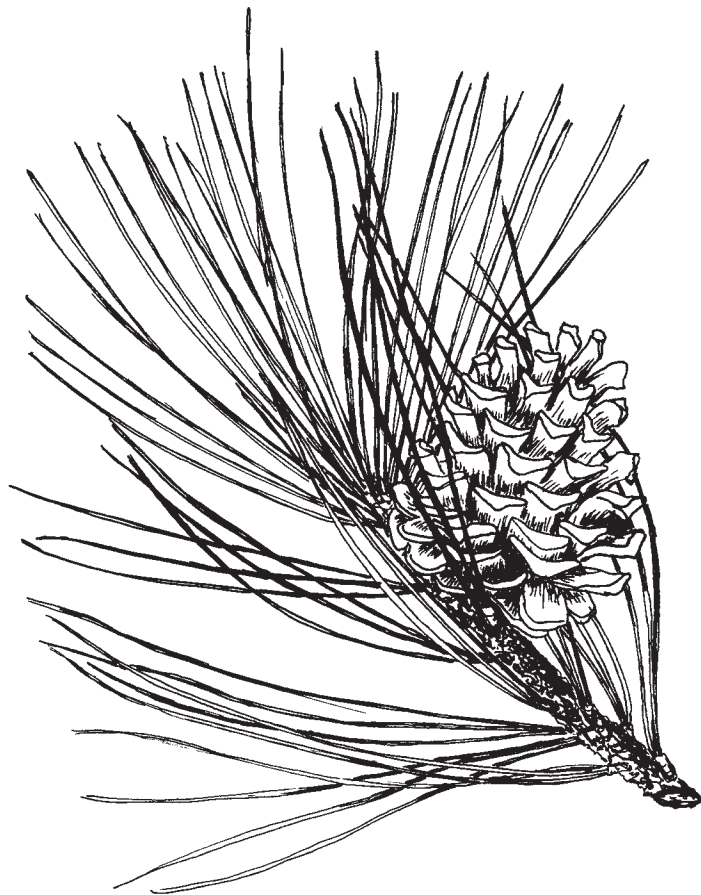

Ponderosa pine drawing by Lorraine Ashland, College of Natural Resources, University of Idaho

Implementing Fungal Cultivation in Biofiltration Systems – The Past, Present, and Future of *Mycofiltration*

Alex W Taylor and Paul E Stamets

Alex W Taylor, Assistant Research Scientist, Fungi Perfecti, LLC, PO Box 7634, Olympia, WA 98507; email: alex.t@fungi.com

Paul E Stamets, Founder and Director of Research, Fungi Perfecti, LLC, PO Box 7634, Olympia, WA 98507; email: paul.s@fungi.com

Taylor AW, Stamets PE. 2014. Implementing Fungal Cultivation in Biofiltration Systems – The Past, Present, and Future of *Mycofiltration*. In: Wilkinson KM, Haase DL, Pinto JR, technical coordinators. National Proceedings: Forest and Conservation Nursery Associations—2013. Fort Collins (CO): USDA Forest Service, Rocky Mountain Research Station. Proceedings RMRS-P-72. 23-28. Available at: http://www.fs.fed.us/rm/pubs/rmrs_p072.html

Abstract: The intentional use of the vegetative growth of mushroom-forming fungi on wood mulch substrates as a biologically active filtration media, a process known as *mycofiltration*, is a promising new technology for enhancing biofiltration of stormwater, graywater, and agricultural runoff. Recent trials have documented that *Escherichia coli* can be selectively removed from contaminated water approximately 20% per cubic foot more effectively by mycofiltration than by wood mulch alone. This improvement in bacteria removal was consistent even after exposure of the mycofiltration media to harsh environmental conditions such as -15 to 40 °C (5 to 140 °F) temperature extremes. This article reviews the historical context, discusses the current state of research, describes best implementation practices, and highlights promising areas for future study to bring the cultivation of fungi in constructed ecosystems into common practice as a new ecological engineering tool for enhancing biological water treatment systems.

Key Words: ecological engineering, mushroom, mycelium, filtration, graywater, bacteria, sediment, stormwater, *E. coli*, fecal coliform

Introduction

Mushroom-forming fungi are primarily terrestrial, aerobic organisms whose vegetative growth takes the form of an intricate and dynamic three-dimensional web of tube-like cells called mycelium (figure 1). The use of the mycelium of select members of the kingdom of fungi for many applications in bioremediation (a process collectively called “fungal bioremediation” or “mycoremediation”) has been well established (Gadd 2001; Singh 2006). Many mushroom-forming fungi of the phylum basidiomycota, which includes well known species such as the oyster mushroom (*Pleurotus ostreatus*) and turkey tail mushroom (*Trametes versicolor*) are further characterized as “white rot,” an informal classification named for the white cellulose-rich material that is left behind as these organisms metabolize the lignin from their wood substrate. The powerful lignin-degrading enzymes produced by these white-rot basidiomycetes—most notably laccase, lignin peroxidase, and manganese peroxidase—are capable of co-degrading a diverse suite of recalcitrant chemical contaminants. Interestingly, several of these chemical degrading species are also known to predate bacteria, produce powerful antibiotic metabolites, and are widely grown commercially due to their ease of cultivation on a wide variety of substrate materials. The incorporation of these organisms into engineered water treatment ecosystems and biofiltration media have demonstrated improvements in bacteria reductions both in the laboratory and at scale. This documented application, among several others under investigation, can provide environmental engineers, water quality professionals and nursery managers with a new tool for enhancing biological water treatment systems.

Fundamental laboratory research supporting the use of wood and leaf litter degrading fungi for ecological services has been widely established in the broader context of mycoremediation. Interest in mycoremediation increased dramatically in the mid-1980s following the discovery of the enzyme lignin peroxidase in the white-rot basidiomycete *Phanerochaete chrysosporium* (Glenn and others 1983; Tien and Kirk 1983).

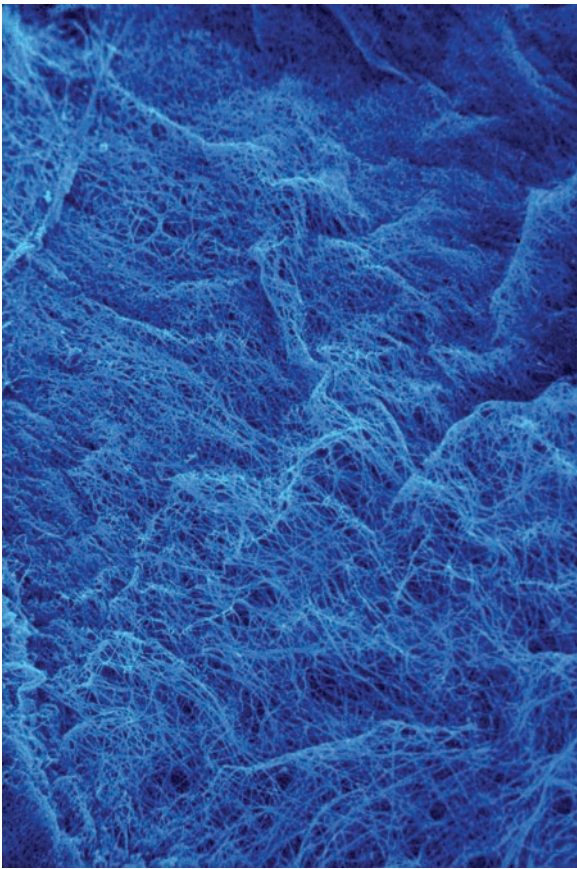

Figure 1. Scanning Electron Micrograph of mycelium viewed at approximately 100x. Credit: Paul Stamets.

Subsequent findings pioneered by Dr. John A. Bumpus and Dr. Steven D. Aust at Utah State University found that lignin peroxidase and other fungal enzymes could efficiently co-degrade persistent chemical toxins (Aust 1990; Bumpus and others 1985). A significant body of research throughout the next several decades documented many applications for white-rot basidiomycete fungi in bioremediation such as the degradation of polycyclic aromatic hydrocarbons (Leonardi and others 2007; Steffen and others 2007); polychlorinated biphenyls (Ruiz-Aguilar and others 2002); and diverse pesticides such as diuron, chlorpyrifos, and atrazine (Bending 2002). Many additional applications and promising bioremediation candidate species including *Pleurotus ostreatus*, *Irpex lacteus*, *Stropharia rugoso-annulata*, and *Trametes versicolor* have been thoroughly reported and reviewed (Singh 2006). By the early 20th century, *P. chrysosporium* was widely recognized as a “model biotechnology fungus” and became the first member of the basidiomycete phylum to be sequenced (Martinez 2004).

Around the same time as the early research on *P. chrysosporium* for chemical degradation, new research was uncovering facets of bacterial-fungal microbial ecology that would later critically inform mycofiltration research. As early as 1961, researchers working to advance the button mushroom industry had discovered that certain bacteria including *Pseudomonas putida*, *Bacillus megaterium*, and *Azotobacter vinelandii* fulfill essential roles in button mushroom cultivation including triggering the formation of mushrooms (Curto and Favelli 1972). Femor and Wood (1981) further documented that several species of wood degrading fungi, particularly basidiomycete

fungi, could even be grown using killed bacteria as the sole nutrient source. Several years later, Dr. George L. Barron at the University of Guelph found that some common and even culinary basidiomycetes such as the button mushroom (*Agaricus brunnescens* = *A. bisporus*), oyster mushroom (*Pleurotus ostreatus*), blewit (*Lepista nuda*), and the scaly ink cap (*Coprinus quadrifidus*) are capable of seeking out and predated living colonies of bacteria (*Agrobacterium tumefaciens* and *Pseudomonas putida*) as sources of nutrition. This work complemented Barron’s previous study documenting that *Pleurotus ostreatus* can also paralyze and consume nematodes (Barron and Thorn 1987). This bacteria-predating feature was unique to basidiomycetes and occurred in only four of the roughly 100 phylogenetically diverse fungal cultures that were screened (Barron 1988).

The term *mycofiltration*—defined as the use of intentionally cultivated networks of fungal mycelium to facilitate water quality improvements in engineered ecosystems—first appears in the literature in 1993 (Stamets 1993). Related concepts such as the use of fungal bioreactors were investigated as early as 1969 for decolorizing Kraft bleach plant effluent (Marton and others 1969), and throughout the 1980s using gel-immobilized fractionated mycelium for wastewater treatment (Livernoche and others 1981). The incorporation of fungi into outdoor biofiltration systems, however, began when a serendipitously placed ‘garden giant’ (*Stropharia rugoso-annulata*) mushroom bed reduced bacteria runoff from upland pasture (Stamets 2005).

The Dawn of Mycofiltration for Pathogen Management

Field trials to replicate the runoff management technique discovered by Stamets in 1993 were conducted intermittently at sites throughout Mason County, Washington, over a ten year period with assistance from the Mason Conservation District, Mason County Public Works and Health Departments, and the Squaxin Island Tribe. The principal reason for interest in this treatment application is that pathogens are the leading cause of water quality impairment in the United States, accounting for over 10,000 Total Maximum Daily Load allocations (TMDLs) nationwide—24% more than the next leading pollutant (National Summary 2012). Urban stormwater and agricultural runoff contribute significantly to this problem (National Research Council 2008; Mishra and others 2008), and leading treatment options are not consistently effective (Clary and others 2010; Center for Watershed Protection 1999). Researchers with the Vermont Association of Conservation Districts and the University of Illinois found that even an integrated runoff management approach incorporating a variety of best management practice (BMP) techniques was not able to consistently remove *E. coli* from dairy runoff (Kominami and Lovell 2012). The burden of bacteria pollution is particularly evident in Washington State, where the shellfish industry is valued at \$80 million annually, and where a single pathogen related closure of a shellfish harvest area can total over \$3 million in losses (Booth and others 2006).

From 2007 to 2008, two mycofiltration treatment studies in north-western Washington documented bacteria removal from agricultural runoff under widely different loading and design parameters. In an experimental treatment conducted by the Mason County Public Works department, a significant though relatively short-term 38% reduction ($p < 0.01$) in fecal coliform bacteria was achieved in a shallow suburban creek (Kenny 2008). Although the high hydraulic loading rate eventually led to anaerobic conditions and dieback of the mycofiltration media, this installation suggested that bacteria reductions could be achieved, even at a flow rate several orders of magnitude larger than typical comparable BMP loading.

These results were corroborated in 2009 by a study conducted by Pacific Northwest National Laboratory under contract to the Jamestown-S'Klallam Tribe. This study evaluated the performance differences in rain gardens (planted bioretention basins) in an agricultural region of the Dungeness watershed of Washington State. Two mirror-image rain gardens were constructed to compare the performance differences between a garden inoculated with *Pleurotus ostreatus* and *Stropharia rugoso-annulata* mycelium and a rain garden without fungal inoculum in the wood mulch layer. The mycelium-enhanced rain garden (figure 2) removed 24% more fecal coliform from runoff at the low influent concentration of 30 colony forming units (CFU)/100 ml than the control rain garden without mycelium. When the experimental treatment cells were spiked with dairy lagoon waste (259,000 CFU/100 ml), the control rain garden had a short-term export of bacteria (376 CFU/100 ml) one hour after the influent spike, while the mycelium-enhanced rain garden resisted coliform export with effluent concentrations remaining below 10 CFU/100 ml over the same period (Thomas and others 2009).

Mesocosm Tests Confirm Treatment Potential

In 2012, a mesocosm-scale study jointly conducted by Fungi Perfecti, LLC and Washington State University (WSU) confirmed the potential of mycofiltration media to remove *E. coli* from synthetic stormwater under laboratory conditions (Beutel and others 2014). The first objective was to identify which fungal species and filter media combinations could maintain biological activity under stressful environmental conditions. The second objective was to quantify the effects of this mycofiltration media on bacteria at different flow rates. Eight fungal strains were grown on five different substrate combinations and were exposed to periods of saturation, drying, heating, and freezing to assess the potential for survival under field-relevant conditions. The ability of mycofiltration media to remove *E. coli* was determined through a series of bench-scale tests conducted independently at

the WSU Department of Civil and Environmental Engineering that compared the *E. coli* removal capacity of the most resilient fungal filters identified by Fungi Perfecti, LLC.

Mycofiltration media treatments consisted of 25 L (6.6 gal) containers with dense but permeable fungal mycelium growth on wood chips or a combination of wood chips and straw. Although several previous field trials documented bacteria removal with *Pleurotus ostreatus*, this species failed to demonstrate resilience to adverse environmental conditions. Notably, *Stropharia rugoso-annulata* and *Irpex lacteus* demonstrated exceptional promise for field applications and were identified as lead candidates based on this criteria. Replicate biofilters were loaded with sediment-free dechlorinated tap water spiked with ~700 CFU/100 ml of *E. coli* at low (0.5 L/min; 0.43 m³/m²·d) and high (2.2 L/min; 1.9 m³/m²·d) hydraulic loading. Influent and effluent samples were monitored over time for fecal coliform and *E. coli* using the Coliscan membrane filter chromogenic method.

Removal of *E. coli* by mycofiltration biofilters was evaluated using media that had been exposed to simulated field conditions. Media that had been exposed to harsh environmental conditions such as -15 to 40 °C (5 to 140 °F) temperature extremes and periods of saturation were termed “Vigor-Tested” biofilters. This media was evaluated in relation to mycofiltration biofilters that had been grown and stored under moderate environmental conditions (Non-Vigor-Tested biofilters) as well as un-inoculated wood chips (Control Filters). *Stropharia rugoso-annulata* grown on wood chips yielded a 20% improvement in *E. coli* removal relative to the wood chip Control Filters (figure 3) at the hydraulic loading rate of 0.5 L/min (0.43 m³/m²·d). The removal of *E. coli* was similar between Vigor-Tested and Non-Vigor-Tested media, although the Non-Vigor-Tested media had lower variability (p<0.05). Additional testing suggested that *E. coli* removal improved when sediment was incorporated into the synthetic stormwater. This result is consistent with other stormwater management research that has documented a correlation between sediment and bacteria removal due to sorption of bacteria onto sediment surfaces and removal by physical mechanisms such as particulate settling or physical straining (Davies and Bavor 2000).

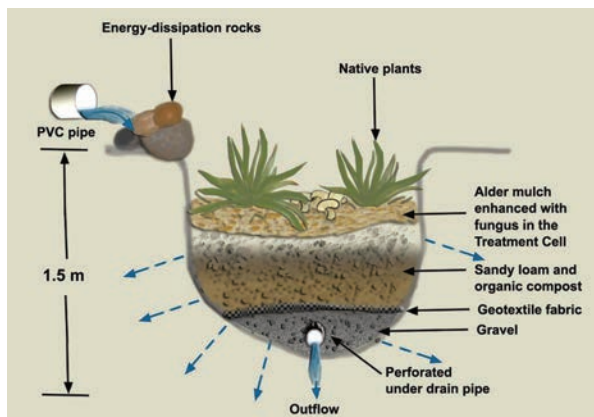

Figure 2. Cross-section schematic of a biofiltration treatment cell containing sand/organic material fill over perforated drainage pipe with native plants and a mycelium enhanced mulch layer (not to scale). Reproduced with permission, courtesy of Pacific Northwest National Laboratory—Report #PNWD-4054-1 (Thomas and others 2009).

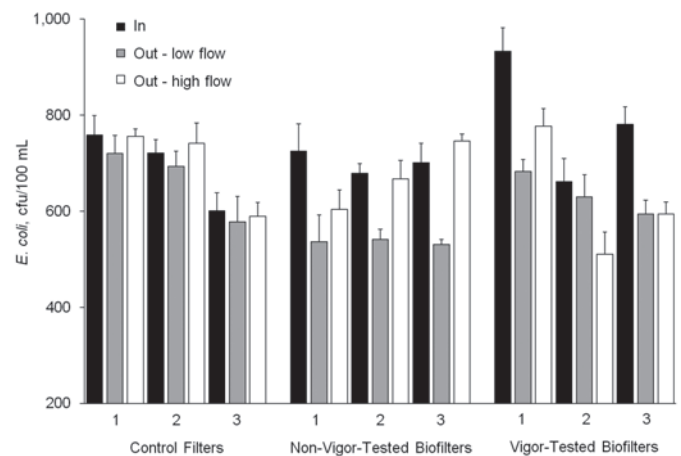

Figure 3. *E. coli* concentration in inflow and outflow from *Stropharia rugoso-annulata* biofilters. Three treatments are shown: Control Filters; Non-Vigor-Tested biofilters; and Vigor-Tested biofilters. Filters were tested under low flow (0.5 L/min) and high flow (2.2 L/min) conditions. Bars are average values and error bars are standard deviation of replicate *E. coli* analyses (n = 2-4). Figure and data from Beutel and others (2014).

Mycofiltration with *Irpex lacteus* appeared less effective; however, the presence of straw in *Irpex* media may have negatively influenced bacteria removal. Mycofiltration and control media that contained straw commonly exported bacteria that tested positive for fecal coliform that was later identified as *Raoultella planticola* (= *Klebsiella planticola*) (Beutel and others 2014; Drancourt and others 2001). This finding corroborated results by Caplenas and Kanarek (1984), when they documented that *Klebsiella* bacteria species grow on woody material yet test positive as “fecal coliform” and confound water quality assays for fecal contamination. While some species of *Klebsiella* such as *Klebsiella pneumoniae* can be pathogens in hospital settings, non-fecal-source members of the genus *Klebsiella* are ubiquitous in the environment. Furthermore, current epidemiological analyses have not identified a correlation between *Klebsiella* bacteria in recreational waters and health risk from fecal-borne pathogens (U.S. EPA 2009). These results highlight the limitation of using the fecal coliform test to assess pathogen removal in biologically rich wood-based ecotechnologies like mycofiltration.

The cultivation of saprophytic basidiomycete fungi into wood mulch as a stand-alone biofilter or as an amendment to a bioretention system has demonstrated the ability to enhance bacteria reductions in water treatment applications under both controlled and uncontrolled environmental conditions (Beutel and others 2014; Thomas and others 2009). Fungal species that demonstrate exceptional resiliency to field-relevant conditions have been identified. Preliminary mesocosm data to optimize flow rate to allow for appropriate sizing of treatment systems has been reported (Beutel and others 2014; Stamets and others 2013). This fundamental delivery system research provides a critical foundation for future research, although key deployment questions such as effective treatment life and relevance of indicator removal to disease risk reduction remain to be answered.

Future Research and Potential Applications

While a number of potential uses of fungal mycelium as a complementary environmental engineering tool are numerous and have been reviewed (Singh 2006; Stamets 2005), recent research continues to highlight new treatment approaches and applications. Studies evaluating fungal cultivation for improving the particulate trapping ability of mycelium-enhanced mulches, fungal enzyme catalyzed sediment-bound pollutant degradation, and the synergistic microbial treatment of chemical and biological pollutants warrant special attention as topics for future research.

Organic materials, such as the straw and woodchip matrix used in the production of mycofiltration media, are commonly used in bioretention systems to help reduce total suspended solids (TSS) by promoting the localized settling of particulates. Given that the surface area of mycelium in the upper 10 cm (3.95 in) of soils has been reported to range from 3 to 90 m² per m² (1.2 to 107.6 yd² per yd²) of ground surface area, it is likely that enhancing mulch with saprophytic soil-interfacing fungi such as *Stropharia rugoso-annulata* and *Irpex lacteus* can improve the TSS removal capacity of these organic materials (Leaky and others 2004). Further, the dense growth habit of some fungi can trap soil particles between their cells (hyphae), effectively forming microaggregates (Gadd and others 2011). Physical straining of particulates may be further increased by mucilaginous fungal excretions, which can contribute to biofilm development (Caesar-Tonthat 2002). As illustrated in figure 4, these properties may improve the physical characteristics of mulch to improve sediment capture, prevent re-suspension of pollutants during high-flow events, and stabilize slopes after wildfires

or the decommissioning of logging roads (Stamets and Summerlin 2011). An added benefit of this approach may also be the reduction of colored effluent from heavily mulched landscapes (figure 5). The removal of tannins, lignin, and related byproducts from pulp effluent has been well researched (Pellinen and Joyce 1990), and this research may translate to reduced chemical oxygen demand exports by mulches that are colonized by white-rot fungi.



Figure 4. Mycelium of the rhizomorph-forming mushroom *Stropharia rugoso-annulata* can dramatically alter the physical and chemical properties of wood mulch for added stabilization and sediment retention, among other applications. Photo credit: Paul Stamets.



Figure 5. Comparison of effluent clarity between Alder (*Alnus rubra*) wood chips colonized by *Stropharia rugoso-annulata* (left) and un-colonized wood chips (right). Media of each was saturated with clean water for four minutes and drained (unpublished data). Photo credit: Alex Taylor.

Mycofiltration research to date has also documented that complex microbial populations can exist in media that is macroscopically dominated by a single species of saprophytic fungus (Flatt 2013). While the microbiome of these systems is certainly complex, export of *Klebsiella* spp. bacteria from straw-containing media both with and without the presence of saprophytic fungi has been documented in mycofiltration trials (Beutel and others 2014). Notably, *Klebsiella* spp. bacteria have been found to degrade a diverse suite of lower molecular weight petroleum hydrocarbons including toluene, xylene, naphthalene, and nonane (Rodrigues and others 2009). There is a large body of laboratory research demonstrating the ability of white-rot fungi to remediate high molecular weight polycyclic aromatic hydrocarbons in soil (Bhatt and others 2002; Leonardi and others 2007). Notably, the most promising fungal species identified for mycofiltration, *Stropharia rugoso-annulata*, has also been identified as one of the most efficient degraders of polycyclic aromatic hydrocarbons (PAHs) among the litter-decomposing fungi, with reductions of up to 70%, 86% and 84% of benzo(a)anthracene, benzo(a)pyrene, and dibenzo(a,h)anthracene, respectively (Steffen and others 2007). Future field trials and controlled mesocosm studies should seek to determine the extent to which the bench-scale removal of aromatic hydrocarbons by fungi can translate to treatment of petroleum contaminated runoff, the prevention of sediment contamination in bioretention cells, and the possibility of synergistic degradation of PAHs by saprophytic fungi and commensal *Klebsiella* spp. bacterial populations.

Synergistic microbial action by mycofiltration media or mycelium-enhanced mulches may also demonstrate promise as future biocontrol agents in nursery applications. Several species of the “imperfect” (non-sexually reproducing) fungus *Trichoderma*, have been used as biocontrol agents against a variety of plant pathogens including species of *Pythium* and *Phytophthora* (Howell 2003). Following biocontrol screening methods described by Elliott and others (2009), a preliminary investigation of *Trichoderma* species for biocontrol against virulent isolates of the forest and nursery pathogen *Phytophthora ramorum* has shown promising results as illustrated in table 1 (Elliott 2013 personal communication). Notably, several species of *Trichoderma* are also common competitor molds in commercial mushroom production since one of the growth characteristics of this organism is an ability to parasitize other fungi. A possible future application of mycofiltration may therefore be to increase *Trichoderma* populations and longevity in soil or biofiltration media by providing host fungi to support the long-term presence of select biocontrol species of *Trichoderma*. Additionally, saprophytic fungi may also act alone as biocontrol agents against nematodes (Barron 1977; Barron and Thorn 1986; Hong and others 2006). The use of mycofiltration media, alone or in combination with other biocontrols, presents a unique opportunity for research in the rapidly growing field of applied microbial ecology for control of plant pathogens.

Table 1. Preliminary investigation for biocontrol against virulent isolates of the forest and nursery pathogen *Phytophthora ramorum*.

Species	% Inhibition of <i>P. ramorum</i> regrowth	% Inhibition of <i>P. ramorum</i> growth
<i>Gliocladium virens</i>	71%	100%
<i>Gliocladium virens</i>	76%	100%
<i>Gliocladium virens</i>	62%	100%
<i>Gliocladium virens</i>	53%	100%
<i>T. atroviride</i>	44%	100%
<i>T. atroviride</i>	56%	100%
<i>T. pseudoharzianum</i>	62%	0%
<i>T. pseudoharzianum</i>	35%	13%

Concluding Remarks

The intentional application of fungi in the environment for ecological services that support human needs and remediate previous human impacts has been well established as an ecologically rational approach. While much work remains to be done in determining best application practices and defining treatment parameters, networking knowledge and skill sets between mushroom cultivators, environmental scientists and policy makers sets the stage for widespread implementation of mycofiltration methods in the near future. As this important body of research advances, the intentional incorporation of fungi in environmental engineering design may one day become as commonplace as the planting of cattails in constructed wetlands is today.

References

- Aust SD. 1990. Degradation of environmental pollutants by *Phanerochaete chrysosporium*. *Microbial Ecology* 20:197-209.
- Barron GL. 1988. Microcolonies of bacteria as a nutrient source for lignicolous and other fungi. *Canadian Journal of Botany*. 66:2525-2510.
- Barron GL, Thorn RG. 1987. Destruction of nematodes by species of *Pleurotus*. *Botany*. 65(4):774-778.
- Bending GD, Friloux M, Walker A. 2002. Degradation of contrasting pesticides by white rot fungi and its relationship with ligninolytic potential. *FEMS Microbiology Letters*. 212(1):59-63.
- Beutel M, Flatt A, Taylor A, Wolff M, Neira L, Wolff M, Brownson K, Stamets P. [In review]. Removal of *Escherichia coli* from synthetic stormwater using mycofiltration. *Ecological Engineering*.
- Bhatt MT, Cajthaml V, Sasek. 2002. Mycoremediation of PAH-contaminated soil. *Folia Microbiologica* 47:255-258.
- Booth D, Visitacion B, Steinemann A. 2006. Damages and costs of stormwater runoff in the Puget Sound region. The Water Center, University of Washington.
- Bumpus JA, Tien M, Wright D, Aust SD. 1985. Oxidation of persistent environmental pollutants by a white rot fungus. *Science* 228:1434-1436.
- Caesar-Tonthat TC. 2002. Soil binding properties of mucilage produced by a basidiomycete fungus in a model system. *Mycological Research* 106(8): 930-937.
- Caplenas NR, Kanarek MS. 1984. Thermotolerant non-fecal source *Klebsiella pneumoniae*: validity of the fecal coliform test in recreational waters. *American Journal of Public Health*. 74:1273-1275.
- Clary J, Leisenring M, Jeray J. 2010. International Stormwater Best Management Practices Database Pollutant Category Summary: Fecal Indicator Bacteria. International Stormwater BMP Database. Center for Watershed Protection. 1999. Watershed Protection Techniques: A Quarterly Bulletin on Urban Watershed Restoration and Protection Tools. 3(1).
- Curto S, Favelli F. 1972. Stimulative effect of certain microorganisms (bacteria, yeasts, microalgae) upon fruit-body formation of *Agaricus bisporus* (Lange) Sing. *Mushroom Science* VIII: 67-74. London.
- Davies CM, HJ Bavor. 2000. The fate of stormwater associated bacteria in constructed wetland and water pollution control pond systems. *Journal of Applied Microbiology*. 89: 349-360.
- Drancourt M, Bollet C, Carta A, Rousselier P. 2001. Phylogenetic analyses of *Klebsiella* species delineate *Klebsiella* and *Raoultella* gen. nov., with description of *Raoultella ornithinolytica* comb. nov., *Raoultella terrigena* comb. nov. and *Raoultella planticola* comb. nov. *International Journal of Systematic and Evolutionary Microbiology*. 51:925-932.

- Elliott M. 2013. Personal communication. Puyallup (WA); Plant Pathologist, Washington State University, Puyallup.
- Elliott M, Shamoun SF, Sumampong G, James D, Masri S, Varga A. 2009. Evaluation of several commercial biocontrol products on European and North American populations of *Phytophthora ramorum*. *Biocontrol Science and Technology*. 19(10):1007-1021.
- Fermor TR, Wood, DA. 1981. Degredation of bacteria by *Agaricus Bisporus* and other fungi. *Journal of General Microbiology*. 126:377-387.
- Flatt AA. 2013. Removal of *Escherichia coli* from stormwater using mycofiltration. Master of Science Thesis Dissertation (In Press). Department of Civil and Environmental Engineering, Washington State University. Pullman, WA.
- Gadd GM, ed. 2001. *Fungi in Bioremediation*. British Mycological Society, Cambridge University Press. Cambridge, U.K.
- Gadd GM, Rhee YJ, Stephenson K, Wei Z. 2011. Geomycology: metals, actinides and biominerals. *Environmental Microbiology Reports*. 4:270-296.
- Glenn JK, Morgan MB, Mayfield MB, Kuwahara M, Gold MH. 1983. An extracellular H₂O₂-requiring enzyme preparation involved in lignin biodegradation by the white-rot basidiomycete *Phanerochaete chrysosporium*. *Biochemical and Biophysical Research Communications*. 114(3): 1077-1083.
- Howell CR. 2003. Mechanisms employed by *Trichoderma* species in the biological control of plant diseases: the history and evolution of current concepts. *Plant Diseases*. 87(1):4-10.
- Kenny S. 2008. Staff Report of Oakland Bay Activities 3/1/08 to 6/30/08. Mason County Public Health Department. Shelton, WA. Retrieved 3/19/2009 from: http://www.co.mason.wa.us/forms/Env_Health/MRA_2008_Qtr2.pdf
- Kominami H, Lovell ST. 2012. An adaptive management approach to improve water quality at a model dairy farm in Vermont, USA. *Ecological Engineering*. 40:141-143.
- Leonardi V, Sasek V, Petruccioli M, D'Annibale A, Erbanova P, Cajthaml T. 2007. Bioavailability modification and fungal biodegradation of PAHs in aged industrial soils. *International Biodegradation and Biodegradation*. 2094:1-6.
- Livernoche D, Jurasek L, Desrochers M, Veliky A. 1981. Decolorization of a kraft mill effluent with fungal mycelium immobilized in calcium alginate gel. *Biotechnology Letters* 3(12). 701-706.
- Marton J, Stern AM, Marton T. (1969). *Tappi* 52 (10), 1975-1981.
- Martinez D, Larrondo LF, Putnam N, Gelpke MDS, Huang K, Chapman J, Helfenbein KG, Ramaiya P, Detter JC, Larimer, Coutinho PM, Henrissat B, Berka R, Cullen D, Rokhsar D. 2004. Genome sequence of the lignocellulose degrading fungus *Phanerochaete chrysosporium* strain RP78. *Nature Biotechnology* 22(6):695-700.
- Mishra A, Benham B, Mostanahimi S. 2008. Bacterial transport from agricultural lands fertilized with animal manure. *Water, Air, & Soil Pollution*. 189(1-4):127-134.
- National Research Council. 2008. *Urban stormwater management in the United States*. Committee on Reducing Stormwater Discharge Contributions to Water Pollution. The National Academic Press, Washington, D.C.
- National Summary of Impaired Waters and TMDL Information. 2012. U.S. Environmental Protection Agency. Office of Water, Washington, D.C. Accessed Oct. 1, 2012 from: http://ofmpub.epa.gov/tmdl_waters10/attains_nation_cy.control?p_report_type=T#tmdl_by_pollutant
- Pellinen J, Joyce TW. 1990. White-rot fungi for treatment of pulp and paper industry wastewater. *Tappi Environmental Conference Proceedings*: 1-13.
- Rodrigues DF, Sakata SK, Comasseto JV, Bicego MC, Pellizari VH. 2009. Diversity of hydrocarbon-degrading Klebsiella strains isolated from hydrocarbon-contaminated estuaries. *Journal of Applied Microbiology*. 106(4):1304-14.
- Ruiz-Aguilar GML, Fernandez-Sanchez JM, Rodriguez-Vazquez R, Poggi-Varaldo H. 2002. Degradation by white-rot fungi of high concentrations of PCB extracted from a contaminated soil. *Advances in Environmental Research* 6(4): 559-568.
- Harbhajan S. 2006. *Mycoremediation: Fungal Bioremediation*. New York: Wiley Interscience.
- Stamets P. 1993. *Growing Gourmet & Medicinal Mushrooms*. Ten Speed Press, Berkeley, CA.
- Stamets P. 2005. *Mycelium Running: How Mushrooms Can Help Save the World*. Ten Speed Press, Berkeley, California.
- Stamets P, Beutel M, Taylor A, Flatt A, Wolff M, Brownson K. 2013. Mycofiltration biotechnology for pathogen management: SBIR Phase I research results for 'comprehensive assessment of mycofiltration biotechnology to remove pathogens from urban stormwater.' Olympia, WA. http://fungi.com/pdf/articles/Fungi_Perfecti_Phase_I_Report.pdf (accessed 15 Sep 2013)
- Stamets P, Summerlin D. 2011. Mycofiltration: a novel approach for the bio-transformation of abandoned logging roads. *NAEP National E-News*. July-Aug: 7-13. The National Association of Environmental Professionals, Collingswood, NJ.
- Steffen KT, Schubert S, Tuomela M, Hatakka A, Hofrichter M. 2007. Enhancement of bioconversion of high-molecular mass polycyclic aromatic hydrocarbons in contaminated non-sterile soil by litter-decomposing fungi. *Biodegradation* 18: 359-369.
- Thomas SA, Aston LM, Woodruff DL, Cullinan VI. 2009. Field demonstration of mycoremediation for removal of fecal coliform bacteria and nutrients in the Dungeness watershed, Washington. *Final Report*. Pacific Northwest National Laboratory. PNWD-4054-1.
- Tien M, Kirk TK. 1983. Lignin-degrading enzyme from the hymenomycete *Phanerochaete chrysosporium*. *Science* 221: 661-663.
- U.S. Environmental Protection Agency. Health and Ecological Criteria Division. 2009. *Review of published studies to characterize relative risks from different sources of fecal contamination in recreational water*. Washington D.C.: Government Printing Office. (EPA 822-R-09-001).

Biofumigation Potential of *Brassica* Soil Amendments in Douglas-fir Seedlings

Bodh R Paudel and Lynne A Carpenter-Boggs

Bodh R Paudel, graduate research assistant at Washington State University, Department of Crop and Soil Sciences, PO Box 646420, Pullman WA 99164; Email: bodh.paudel@wsu.edu

Lynne A Carpenter-Boggs, Associate Professor (Sustainable and Organic Agriculture), Washington State University, Department of Crop and Soil Sciences, PO Box 646420, Pullman WA 99164; Email: lcboggs@wsu.edu

Paudel BR, Carpenter-Boggs LA. 2014. Biofumigation Potential of *Brassica* Soil Amendments in Douglas-fir Seedlings. In: Wilkinson KM, Haase DL, Pinto JR, technical coordinators. National Proceedings: Forest and Conservation Nursery Associations—2013. Fort Collins (CO): USDA Forest Service, Rocky Mountain Research Station. Proceedings RMRS-P-72. 29-34. Available at: http://www.fs.fed.us/rm/pubs/rmrs_p072.html

Abstract: *Fusarium* root rot is one of the major soil borne diseases of conifers. Soil fumigation with methyl bromide has been the most effective control method. Because of safety and environmental concerns, methyl bromide use is increasingly restricted. However, the conifer seedling industry continues to use methyl bromide under a critical use exemption due to a lack of effective alternatives. A field study was conducted to examine the effects of *Brassica* seed meals and green manures on management of selected soil borne pathogens. The study consisted of five treatments: *Brassica juncea* seedmeal (BJSM), *Brassica carinata* seedmeal (BCSM), *Brassica juncea* green manure (BJGM), methyl bromide/chloropicrin fumigation (MBC) and control, with four replications in randomized complete block design. The treatments were incorporated into soil in fall (September 2011) and Douglas-fir (*Pseudotsuga menziesii*) seedlings were transplanted into plots in spring (May 2012). Pathogen populations, nitrogen mineralization rate, and dehydrogenase enzyme activity in soil were assessed at pre-transplant, post-transplant, and seedling harvest. The initial pathogen count was not significantly different among treatments. At transplant time, *Fusarium* spp. were significantly lower in BJGM (146 CFU g⁻¹) than MBC (290 CFU g⁻¹), and control (357 CFU g⁻¹); whereas *Trichoderma* were significantly higher in MBC (5716 CFU g⁻¹) followed by BJGM (3031 CFU g⁻¹), and control (1763 CFU g⁻¹). Dehydrogenase enzyme activity was highest in BJGM (0.81 µg TPF g⁻¹ hr⁻¹) followed by BJSM (0.62 µg TPF g⁻¹ hr⁻¹). Similarly, the mineralizable nitrogen was higher in BJGM (5.8 and 6.8 µg NH₄ g⁻¹ during 7- and 28-day incubation respectively) followed by BJSM (4.0 and 5.8 µg NH₄ g⁻¹). These preliminary results suggest that *B. juncea* green manure has a suppressive effect on soil borne pathogens, and both green manure and seed meals have positive impacts on soil quality.

Key Words: *Fusarium* root rot, *Brassica* green manure, *Brassica* seed meals, methyl bromide, soil health

Introduction

Fusarium spp. cause many diseases in conifer seedlings (Hamm and Hansen 1989; Brownell and Schneider 1983), some of the most intense being damping-off, blight and root rot (James 1986; Landis 1989; Hamm and others 1990). The conifer seedling nursery industry currently is facing enormous pressures from fungal diseases. The Nursery Technology Cooperative (NTC 2009) stated that the pathogens causing the most significant threats to bareroot nurseries are *Fusarium*, *Pythium*, and *Cylindrocarpon*. *Fusarium* root rot is one of the most common soil borne diseases of conifer seedlings. This disease is a serious problem on many different species of conifers and generally occurs wherever bare root nursery stock is produced. In addition to causing significant losses in the nursery, the survival and growth of out-planted seedling can also be adversely affected, resulting in significant replanting costs. *Fusarium* and other soil-borne pathogens must be managed for profitable nursery production, and more cost-effective management options are needed.

Fusarium species are found worldwide in soil and decaying plant debris (Moss and Smith 1984). About half of the 40 species in the genus are parasitic on higher plants causing root rot, vascular wilts and storage rots (Booth 1984; Price 1984). *Fusarium* root rot of conifer seedlings caused by several species of *Fusarium* is the most serious disease in Pacific Northwest bare-root nurseries, causing severe crop and economic losses annually. *Fusarium* spp. are ubiquitous in most container and bareroot nurseries, where they occur on healthy and diseased conifer seedlings, especially Douglas-fir (*Pseudotsuga menziesii*), western white pine (*Pinus monticola*) and ponderosa pine (*Pinus ponderosa*) (James and others 1997). The major fungal pathogen was previously identified as *F. oxysporum* based on morphology (Bloomberg 1981). However, among morphologically identified *F. oxysporum* isolates from Douglas-fir seedlings and soil, Stewart and others (2006) found that disease symptoms were caused only by *F. commune*, a genetically distinct recently named species (Skovgaard and others 2003).

Application of soil fumigants like methyl bromide (MeBr) and metam sodium before transplanting seedlings has been the basis for the control of soil-borne pests in developed countries. Soil fumigation is commonly used in bare-root forest nurseries to manage soilborne pests including fungal pathogens, nematodes, weeds, and insects. Formulations of methyl bromide and chloropicrin were the most commonly used fumigant treatments in US forest nurseries (Smith and Fraedrich 1993). Methyl Bromide has been the most extensively used commercial chemical because it is considerably more effective. However, methyl bromide was listed as one of the ozone depleting substance by the Montreal Protocol in 1992 and its production was discontinued by 1995 (Prather and others 1984; Bell and others 1996). This became a major concern to farmers in countries including US where it is used for the production of economically important crops including forest seedlings. However, growers are continuing use of MeBr under critical use exemption (Byrd and others 2006). Consequently, finding alternatives to MeBr use has become crucial.

Biofumigation is the beneficial use of *Brassica* green manures that release isothiocyanates chemically similar to methyl isothiocyanate, the active agent from the synthetic fumigant (Kirkegaard and others 1993; Matthiessen and Kirkegaard 2006; Omirou and others 2011). The exploitation of maximum biofumigation potential has been a key research goal. The factors affecting the release of isothiocyanates into soil have been intensively researched. This understanding has led to some commercial adoption of biofumigation, which when applied to appropriate production systems, can have efficacy and offer cost savings. More research is needed to confirm the efficacy of biofumigation in Douglas-fir seedlings. A field study was conducted to examine the effects of *Brassica* seed meals and green manures on management of selected soil borne pathogens. The major objective of this was to determine effects of soil amendment with green manure or seed meal of *Brassicaceous* spp. on soil and root pathogen levels and beneficial organisms like *Trichoderma*. The *Trichoderma* spp. are beneficial fungal populations that can naturally act as biological control agents for several soil-borne pathogens (Kucuk and Kivanc 2003) via various mechanisms like competition with the pathogen for nutrients and direct parasitism, antibiosis, induced resistance, and production of cell wall degrading enzymes (Verma and others 2007; Alabouvette and others 2009). We hypothesized that one or more *Brassica* seed meals or green manure will reduce *Fusarium* on seedling root and soil compared to untreated soils and will also enhance soil health and beneficial organisms.

Materials and Methods

Study Area and Treatments

The study was conducted in IFA Nurseries, Toledo Washington. The study consisted of five treatments:

- *Brassica juncea* seedmeal (BJSM),
- *Brassica carinata* seedmeal (BCSM),
- *Brassica juncea* green manure (BJGM),
- methyl bromide/chloropicrin fumigation (MBC, 67% methyl bromide and 33% chloropicrin) (positive control) and
- no treatment (negative control)

The study was carried out with four replications in randomized complete block design (RCBD). The *Brassica* seed meals at 4.94 tons ha⁻¹ (4409 lbs acre⁻¹), *Brassica juncea* green manure at 11.2 kg seeds ha⁻¹ (10 lbs acre⁻¹) and MBC at 392.2 kg ha⁻¹ (350 lbs acre⁻¹) were incorporated into soil in fall (September 2011) followed by tarping with plastic until next spring. Douglas-fir (*Pseudotsuga menziesii*) seedlings were transplanted into plots in spring (May 2012). Pathogen populations, nitrogen mineralization rate, and dehydrogenase enzyme activity in soil were assessed.

Sampling

Soil samplings were conducted four times (pre-treatment September 2011, pre-transplant May 2012, post-transplant July 2012, and harvest January 2013) during the study period. Ten sub-samples were taken from 0-15 cm (0-5.9 in) in each plot using core sampler and were mixed well in a zip-lock bag. Aseptic procedure was used to avoid cross contamination between treatments. The sampling bags were sealed and transported to the laboratory in a cooler. All samples were maintained at field moist condition and were stored at 4 °C (39.2 °F) until analyzed.

Laboratory Analyses

Soil pathogens were analyzed using 2.5 g (0.088 oz) soil and following standard laboratory procedure of soil dilution plating. *Pythium* were grown and enumerated in V8 agar medium (Stevens 1974) and *Fusarium* along with *Trichoderma*, actinomycetes were grown on Komoda's medium (Komoda 1976).

Dehydrogenase enzyme activity was assayed with triphenyl tetrazolium chloride reduction (Tabatabai 1994). The results were quantified colorimetrically, standardized with standard curve and expressed as triphenyl formazan (TPF) g⁻¹ soil hr⁻¹.

Mineralizable nitrogen was quantified in 7- and 28-day incubation at 40 °C (104 °F) and ammonium quantification (Waring and Bremner 1964).

Statistical Analyses

Data were analyzed using randomized complete block design in statistical analysis software SAS version 9.3 (SAS 2008) using Proc GLM procedure. Data collected in each sampling were analyzed separately to determine treatment effect for each parameter. Pairwise comparisons of treatment means were conducted using Tukey's procedure and differences were declared significant at five percent level of significance (p≤0.05).

Results

Soil Pathogens Counts

The initial pre-treatment counts of *Fusarium* ranged from 1298 to 1659 colony forming units (CFUs) g⁻¹ dry soil and *Trichoderma* ranged from 5615 to 7472 CFUs g⁻¹ among treatments. Although there is numerical variation as expected, those were not statistically significant (data not shown). The following spring after treatment, *Fusarium* counts were significantly lower in BJGM treatment (146 CFU g⁻¹ soil) followed by MBC (290 CFU g⁻¹ soil) (figure 1) and *Trichoderma* counts were significantly higher in MBC and BJGM compared to control (figure 2).

At post-transplant time, the *Fusarium* population was significantly lower in BJGM and MBC treatments compared to control (figure 1). At harvest time, the *Fusarium* populations increased in number in all treatments but were significantly lower in the soil amendment treatments (BJGM, BJSJ, and BCSM) compared to control (figure 1).

Similarly, the *Trichoderma* were highly variable at post-transplant time, and harvest (figure 2). The *Trichoderma* were significantly higher in MBC and BJGM compared to control at summer. However, there were not significant variation among soil amendments and control at harvest (figure 2).

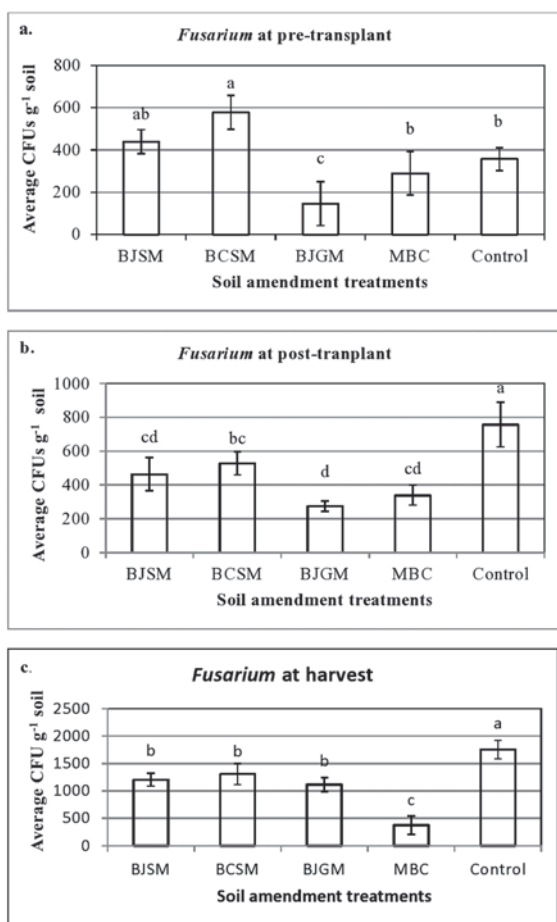

Figure 1. Bulk soil populations of *Fusarium* spp. in five study treatments, *Brassica juncea* seed meal (BJSJ), *Brassica carinata* seed meal (BCSM), *Brassica juncea* green manure (BJGM), methyl bromide/chloropicrin fumigation (MBC) and control at pre-transplant, May 2012 (a.), post-transplant, July 2012 (b.), and seedling harvest, January 2013 (c.). Treatments were applied to soil the prior September 2011.

The *Pythium* populations were also significantly suppressed by MBC at all post-treatment samplings but there were not any significant difference among other treatments (data not shown). A high variability was observed in actinomycetes populations among study treatments (data not shown).

Soil Quality Assessment

Soil dehydrogenase activity, an indicator of total microbial oxidizing activity, was similar among treatments at pre-transplant time (table 1). At post-transplant, BJGM had significantly greater activity (0.81 μg TPF g⁻¹ hr⁻¹) compared to MBC (0.57 μg TPF g⁻¹ hr⁻¹) (table 1). At harvest all *Brassica* treatments had significantly greater activity compared to MBC, and BJGM was also greater than control.

Mineralizable nitrogen at pre-transplant was significantly greater in BJGM compared to MBC and there were no difference among other treatments (P≤0.1). After both 7- and 28-day incubation of soil samples, the extractable ammonium trend was BJGM > control > MBC (table 2.)

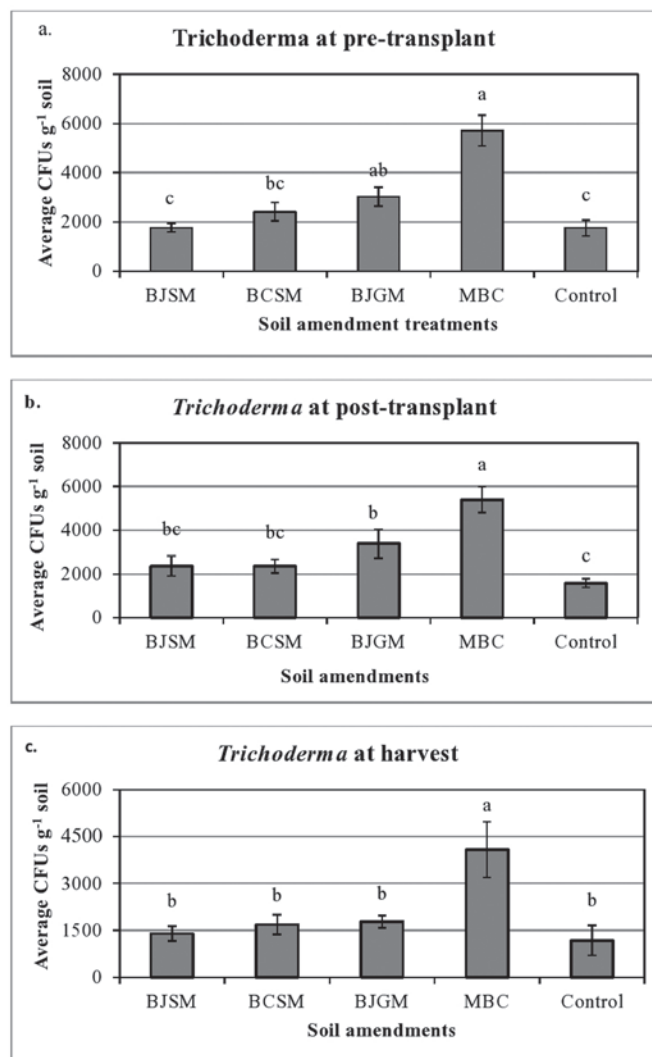

Figure 2. *Trichoderma* population in soil in five study treatments, *Brassica juncea* seed meal (BJSJ), *Brassica carinata* seed meal (BCSM), *Brassica juncea* green manure (BJGM), methyl bromide/chloropicrin fumigation (MBC) and control at pre-transplant (a.), post-transplant (b.) and harvest time (c.)

Table 1. Dehydrogenase enzyme activity in bulk soil at seedling transplant as affected by study treatments *Brassicajunceae* seed meal (BJSM), *Brassicacarinata* seed meal (BCSM), *Brassicajunceae* green manure (BJGM), methyl bromide/chloropicrin fumigation (MBC) and control.

Treatments	Dehydrogenase enzyme activity ($\mu\text{g TPF g}^{-1} \text{hr}^{-1}$)		
	Pre-transplant	Transplant	Harvest
BCSM	0.485 a	0.570 b	0.670 ab
BJGM	0.463 a	0.810 a	0.735 a
BJSM	0.452 a	0.618 b	0.617 ab
MBC	0.384 a	0.585 b	0.310 c
Control	0.366 a	0.688 ab	0.463 bc

Data followed by same letter within a column were not significantly different ($P \leq 0.05$)

Table 2. Mineralizable nitrogen as affected by treatments at pre-transplant *Brassicajunceae* seed meal (BJSM), *Brassicacarinata* seed meal (BCSM), *Brassicajunceae* green manure (BJGM), methyl bromide/chloropicrin fumigation (MBC) and control

Treatments	Net $\mu\text{g NH}_4\text{-N g}^{-1}$ soil	
	7-day incubation	28-day incubation
BCSM	2.53 b	5.87 a
BJGM	5.78 a	6.82 a
BJSM	4.01 ab	5.82 a
MBC	3.80 b	3.63 b
Control	4.15 ab	5.73 a

Data followed by same letter within a column were not significantly different ($P \leq 0.1$)

Discussion

In this study and in most conifer nurseries using fumigation or green manures, treatments were applied in the fall. By the next spring, *Fusarium* populations in all treatments including control were much lower, with BJGM the lowest. Several studies have observed similar reductions in *Fusarium* after *Brassica* plant tissue incorporation (Subbarao and others 1999; Pinkerton and others 2000; Smolinska 2000; Mazzola and others 2001; Cohen and others 2005; Mazzola and Mullinix 2005). *Fusarium* populations increased over the growing season in all treatments but at harvest all treatments had lower populations than control.

There are examples of research where *Brassica* amendments have been successful for soil-borne pathogen control (Subbarao and others 1999; Cohen and others 2005) as well as examples of failure (Blok and others 2000; Zasada and others 2003). In a few similar studies, the *Fusarium* and *Pythium* populations in *Brassica* amended soils were even significantly higher than those in control (Njoroge and others 2008). Hence, the effect of biofumigation has not been consistent, possibly due to many factors. It has been reported that after soil amendments with *Brassicajunceae* and *Brassicanapus*, the populations of both fungi and bacteria including *Fluorescent pseudomonads* increased compared with nonamended soils (Smolinska 2000). Hence there may be additional biological mechanisms governing disease control by brassicas besides glucosinolate hydrolysis to isothiocyanates (Blok and others 2000; Takehara and others 2004; Cohen and others 2005).

The populations of pseudomonads do not always change following *Brassica* amendments (Scott and Knudsen 1999). This suggests that the type of *Brassica*, even genotype of plant (Mazzola and Gu 2002), and the soil type may influence the effect on fluorescent pseudomonads and other beneficial and pathogenic organisms. It is highly important to monitor the plant pathogens as well as beneficial organisms to better characterize the effect of soil amendments.

In this study, the decrease in *Fusarium* populations was highly correlated with increase in *Trichoderma* counts (figure 1, 2). The effects of *Brassica* seed meals were not as great as *Brassica* green manure which also resembles other research in similar arenas (Mazzola and Gu 2002). *Brassica* seed meals were more effective in disease and weed control when used in combination or certain formulation (Mazzola and Brown 2010).

Green manures and other organic amendments can also provide benefits to following crops and to farming systems in general, including maintenance of soil cover and soil integrity, soil sanitization, reduced erosion, greater soil organic matter, and soil structural improvements that improve water penetration (Bailey and Lazarovits 2003; Thorup-Kristensen and others 2003). On sandy irrigated soils, the inclusion of *Brassica* green manure crops has reduced the level of wind erosion and improved the water infiltration of soils, with improvement in soil structure (Gies 2004; McGuire 2004). *Brassica* green manure crops are effective at capturing soil mineral nitrogen, and when incorporated into the soil can provide a source of organic nitrogen that can become available to subsequent crops. These improvements to crop nutrition and water relationships may also improve disease tolerance regardless of changes in soil microbial communities.

Following the dynamics of soil organisms, the soil dehydrogenase activity, which represents overall soil oxidation activity, was enhanced by *Brassica* green manure (table 1). Also the mineralizable nitrogen was marginally higher in *Brassica* green manure treatment. These improvements may be attributed to the increased organic matter and greater activities of roots compared to un-amended soil (Myers and others 2001; Kremer and Li 2003; Mungai and others 2005). Increased foodstuffs directly from amendments and indirectly from root exudation may enhance the diversity of organisms and the ecosystem functions they perform. More overall microbial activity and available organic nitrogen may thereby improve seedling health.

Conclusions

The nature of results of *Brassica* soil amendments observed in this study support the hypothesis that *Brassica* green manure or seed meals will suppress soil pathogens and enhance beneficial organism in soil. Results hold true that the effectiveness and mechanism of disease suppression are influenced by various factors including *Brassica* species and variety, soil texture, and timing and process of incorporation. To conclude, the *Brassicajunceae* green manure showed good potential to control *Fusarium spp.* in Douglas-fir seedling soil and enhance soil health.

References

- Alabouvette C, Olivain C, Migheli Q, Steinberg C. 2009. Microbiological control of soil-borne phytopathogenic fungi with special emphasis on wilt-inducing *Fusarium oxysporum*. *New Phytologist* 184: 529–544
- Bailey K, Lazarovits G. 2003. Suppressing soil-borne diseases with residue management and organic amendments. *Soil Till Res* 72:169–180.

- Bell CH, Price N, Chakrabarti B. 1996. The Methyl bromide issue. John Wiley and Sons, New York, N.Y.
- Blok WJ, Lamers JG, Termorshuizen AJ, Bollen GJ. 2000. Control of soilborne plant pathogens by incorporating fresh organic amendments followed by tarping. *Phytopathology* 90:253-259.
- Bloomberg WJ. 1981. Disease caused by *Fusarium* in forest nurseries. In: *Fusarium: Diseases, Biology and Taxonomy*, Ed. by Nelson PE, Tousson TA, Cook RJ. University Park, PA: The Pennsylvania State University Press, pp. 178-187.
- Booth C. 1984. The *Fusarium* problem: historical, economic and taxonomic aspects. pp. 1-13 In: Moss, M. JE Smith (eds.) *The applied mycology of Fusarium*. Cambridge University Press, Cambridge
- Brownell KH, Schneider RW. 1983. *Fusarium* hypocotyl rot of sugar pine in California nurseries. *Plant Dis.* 67: 105-107
- Byrd M, Fonsah EG, Escalante C, Wetzstein M. 2006, March. The Impact on Farm Profitability and Yield Efficiency of Bell Pepper Production of the Methyl Bromide Phase-Out Program in Georgia. *Journal of Food Distribution Research.* 37(1): 48-50.
- Cohen, MF, Yamasaki H, Mazzola M. 2005. *Brassica napus* seed meal soil amendment modifies microbial community structure, nitric oxide production and incidence of *Rhizoctonia* root rot. *Soil Biol. Biochem.* 37:1215-1227.
- Gies D. 2004. Commercial use of mustards for green manure and biofumigation in the United States. *Agroindustria* 3: 403-405
- Hamm PB, Hansen EM. 1989. *Fusarium* hypocotyl rot. pp. 120-121 In: Cordell CE, Anderson RL, Hoffard WH, Landis TD, Smith RS, Toko HV. (Eds) *Forest Nursery Pests*. U.S. Dept. of Agriculture Handbook No. 680.
- Hamm PB, Campbell SJ, Hansen EM. 1990. Growing Healthy Seedlings: Identification and management of pests in Northwest forest nurseries. Special Pub. 19. 110 pp. Forest Research Laboratory, Oregon State University, Corvallis, OR.
- James RL. 1986. Diseases of conifer seedlings caused by seed-borne *Fusarium* species. pp. 267-271 In: Shearer RC (ed.) *Proc. Conifer Tree Seed in the Inland Mountain West Symposium*. U.S. Dept. of Agriculture Forest Service, Intermountain Research Station, Missoula, MT.
- James RL, Dumroese RK, Wenny DL. 1997: Pathogenicity of *Fusarium proliferatum* in container-grown Douglas-fir seedlings. In: *Proceedings of the Third Meeting of IUFRO Working Party S7.03-04 (Disease and Insects in Forest Nurseries)*, Ed. By James RL, USDA Forest Service, Northern Region, Forest Health Protection. Report 97-4. pp 26-33.
- Kirkegaard JA, Gardner PA, Desmarchelier JM, Angus JF: 1993. Biofumigation- using *Brassica* species to control pests and diseases in horticulture and agriculture. In: Wratten N, Mailer R. (Eds.), *Proceedings of the 9th Australian Research Assembly on Brassicas*. NSW Agriculture, pp. 77-82.
- Komada H. 1976. A new selective medium for isolating *Fusarium* from natural soil. *Proceedings of the American Phytopathological Society* 3:221.
- Kremer RJ, Li J. 2003. Developing weed-suppressive soils through improved soil quality management. *Soil Till. Res.* 72:193-202.
- Kucuk C, Kivanc M. 2003. Isolation of *Trichoderma* spp. and determination of their antifungal, biochemical and physiological features. *Turkish Journal of Biology* 27:247-253.
- Landis TD. 1989. Disease and pest management. pp. 1-99 In: Landis TD, Tinus RW, McDonald SE, Barnett JP. (eds.) *The container tree nursery manual*, Volume 5. U.S. Dept. of Agriculture Handbook 674, Washington, DC.
- Matthiessen JN, Kirkegaard JA. (2006). Biofumigation and Enhances Biodegradation: Opportunity and Challenge in Soilborne Pest and Disease Management. *Critical Reviews in Plant Science* 25: 235-265.
- Mazzola M, Brown J. 2010. Efficacy of brassicaceous seed meal formulations for the control of apple replant disease in conventional and organic production systems. *Plant Dis* 94:835-842.
- Mazzola M, Gu YH. Wheat genotype-specific induction of soil microbial communities suppressive to *Rhizoctonia solani* AG 5 and AG 8. *Phytopathology*. 2002;92:1300-1307.
- Mazzola M, Mullinix K. 2005. Comparative field efficacy of management strategies containing *Brassica napus* seed meal or green manure for the control of apple replant disease. *Plant Dis.* 89:1207-1213.
- McGuire AM. 2004. Mustard green manure crops replace fumigant and improve infiltration in potato cropping system. *Agroindustria* 3:331-333.
- Moss MO, Smith JE. 1984. *The applied mycology of Fusarium*. Cambridge University Press, Cambridge.
- Mungai WN, Motavalli PP, Kremer RJ, Nelson KA. 2005. Spatial variation in soil enzyme activities and microbial functional diversity in temperate alley cropping systems. *Biol. Fert. Soils* 42, 129-136.
- Myers RT, Zak DR, White DC, Peacock A. 2001. Landscape-level patterns of microbial community composition and substrate use in upland forest ecosystems. *Soil Sci. Soc. Am. J.* 65, 359-367.
- Njoroge S, Riley MB, Keinath AP. 2006. Effect of biofumigation with *Brassica* crops on population densities of soilborne pathogens in South Carolina. (Abstr.) *Phytopathology* 96:S85.
- NTC. 2009. Nursery Technology Cooperative Strategy Meeting for Bareroot Nursery Sustainability Following EPA Soil Fumigant Registration Eligibility Decisions. January 28 2009.
- Omirou M, Rousidou C, Bekris F, Papadopoulou KK, Menkissoglou-Spiroudi U, Ehaliotis C, Karpouzias DG. 2010. The impact of biofumigation and chemical fumigation methods on the structure and function of the soil microbial community. *Microbial Ecology* 61(1) 201-213.
- Pinkerton JN, Ivors, KL, Miller M L, Moore LW. 2000. Effect of soil solarization and cover crops on populations of selected soilborne plant pathogens in western Oregon. *Plant Dis.* 84:952-960.
- Prather MJ, McElroy MB, Wofsy SC. 1984. Reduction in ozone at high concentrations of stratospheric halogens. *Nature* 312:227-231.
- Price D. 1984. *Fusarium* and plant pathology: the reservoir of infection. pp. 71-93 In: Moss MO, Smith JE. (eds.) *The applied mycology of Fusarium*. Cambridge University Press, Cambridge.
- SAS. 2008. Statistical software package SAS version 9.3. SAS Institute, NC, USA.
- Scott JS, Knudsen GR. 1999. Soil amendment effects of rape (*Brassica napus*) residues on pea rhizosphere bacteria. *Soil Biol. Biochem.* 31:1435-1441.
- Skovgaard K, Rosendahl SO, Donnell K, Hirenberh HI. 2003: *Fusarium commune* is a new species identified by morphological and molecular phylogenetic data. *Mycologia* 95:630-636.
- Smith RS, Fraedrich SW. 1993. Back to the future—Pest management without methyl bromide. *Tree Planters' Notes* 44:87-90.
- Smolinska U. 2000. Survival of *Sclerotium cepivorum* sclerotia and *Fusarium oxysporum* chlamydospores in soil amended with cruciferous residues. *J. Phytopathol.* 148:343-349.
- Stevens RB. 1974. *Mycology Guidebook*. University of Washington Press, Seattle, WA. 703 pp.

- Stewart JE, Kim MS, James RL, Dumroese RK, Klopfenstein NB. 2006. Molecular characterization of *Fusarium oxysporum* and *F. commune* isolates from a conifer nursery. *Phytopathology* 96, 1124–1133.
- Subbarao KV, Hubbard JC, Koike ST. 1999. Evaluation of broccoli residue incorporation into field soil for Verticillium wilt control in cauliflower. *Plant Dis.* 83:124-129.
- Tabatabai MA. 1994. Soil enzymes. In: Weaver RW, Angle JS, Bottomley PS. (Eds.), *Methods of Soil Analysis, Microbiological and Biochemical Properties*. SSSA Book. Soil Sci. Soc. Am., Madison, WI: 775–833.
- Takehara T, Hanzawa S, Funabara M, Nakaho K, Nakagawa A. 2004. Control of soilborne pathogens using allelopathic plants to lower redox potential of soil. (Abstr.) *Phytopathology* 94:S101.
- Thorup-Kristensen K, Magid J, Jensen LS. 2003. Catch crops and green manures as biological tools in nitrogen management in temperate zones. *Advances in Agronomy* 79: 227-301
- Verma M, Brar SK, Tyagi RD, Sahai V, Pre'vost D, Vale'ro JR, Surampalli RY. 2007. Bench-scale fermentation of *Trichoderma viride* on wastewater sludge: Rheology, lytic enzymes and biocontrol activity. *Enzyme and Microbial Technology* 41:764-771.
- Waring SA, Bremner JM. 1964. Ammonium production in soil under waterlogged conditions as an index of nitrogen availability. *Nature* 201:951-952 1964.
- Zasada IA, Ferris H, Elmore CL, Roncoroni JA, MacDonald JD, Bolkran LR, Yakabe LE. 2003. Field application of brassicaceous amendments for control of soilborne pests and pathogens. Online. *Plant Health Progress*. doi:10.1094/PHP-2003-1120-01-RS.

Soil Fumigation: Regulatory Update, Phase II Labels, Buffer Zone Specifics

Jeff Fowler

Jeff Fowler, General Manager, Trident Agricultural Products, 346 N Pekin Rd, Woodland WA 98674; E-mail: jfowler@tridentag.com

Fowler J. 2014. Soil Fumigation: Regulatory Update, Phase II Labels, Buffer Zone Specifics. In: Wilkinson KM, Haase DL, Pinto JR, technical coordinators. National Proceedings: Forest and Conservation Nursery Associations—2013. Fort Collins (CO): USDA Forest Service, Rocky Mountain Research Station. Proceedings RMRS-P-72. 35-37. Available at: http://www.fs.fed.us/rm/pubs/rmrs_p072.html

Abstract: New safety measures for soil fumigant pesticide applications implemented by the US Environmental Protection Agency (EPA) affect bareroot nursery applications of methyl bromide, chloropicrin, metam sodium/metam potassium, and dazomet. This paper summarizes some highlights from the EPA's fact sheets about safety and risk mitigation measures, including buffer zones and emergency preparedness requirements. Readers are directed to the original fact sheets, found in the EPA's online "Soil Fumigants Toolbox" http://www.epa.gov/pesticides/reregistration/soil_fumigants/

Key Words: methyl bromide, chloropicrin, metam sodium/metam potassium, dazomet, safety

Introduction

Information in this paper was abridged from at the following EPA publications:

- *Soil Fumigant Mitigation Factsheet: Buffer Zones*
- *Soil Fumigant Mitigation Factsheet: Emergency Preparedness and Response Requirements and*
- *Implementing New Safety Measures for Soil Fumigant Pesticides*

Web links for these publications are provided in the references.

As of December 1, 2012, a final set of soil fumigant product label changes went into effect, fully implementing important new protections for workers and bystanders. The amended product labels incorporate the second and final phase of mitigation measures required by the EPA's 2009 Reregistration Eligibility Decisions (REDs) for the soil fumigants methyl bromide, chloropicrin, metam sodium/metam potassium, and dazomet. The new measures appearing on soil fumigant Phase 2 labels include buffer zones, posting, credits, and overlap prohibition, emergency preparedness and response measures, restrictions on applications near sensitive sites, applicator training, first responder and community outreach, and compliance assistance and assurance measures. This paper excerpts key EPA information on buffer zone related mitigation measures.

Buffer Zones

Distance and Period

A buffer zone provides distance between the application site (i.e., edge of field) and bystanders. The buffer zone period starts at the moment when any fumigant is delivered/dispensed to the soil within the application block and lasts for a minimum of 48 hours after the fumigant has stopped being delivered/dispensed to the soil. All non-handlers including field workers, nearby residents, pedestrians, and other bystanders must be excluded from the buffer zone during the buffer zone period, except for people in transit. A buffer zone must be established around the perimeter of each application block where a soil fumigant is applied. The buffer zone must extend from the edge of the application block perimeter equally in all directions.

The size of the buffer zone can range from 25 ft (7.6 m) to 2640 ft (804.5 m). The size of the buffer zone is determined by four factors:

- *product formulation*
- *application rate*
- *field size (acres)*
- *application equipment and methods.*

Every product label will have a series of buffer zone tables; each application method will have its own table.

EPA Credits

EPA is giving “credits” to encourage applicators to employ practices that reduce emissions. Buffer credits will reduce buffer distances, and include organic matter and clay content of soils, soil temperature, potassium thiosulfate, water seal, and use of vapor-retentive films like “totally impermeable film” (TIF). Credits are additive, but cannot exceed 80%. Additionally, the minimum buffer zone distance is 25 ft (7.6 m) regardless of buffer zone credits available.

Proximity/Overlap

Before the start of the application, the certified applicator must determine whether their buffer zone will overlap any other buffer zones. Two or more adjacent blocks can be fumigated at the same time if buffers do not overlap. If buffers will overlap, then applications must be staggered by at least 12 hours and may require buffer monitoring or neighbor notification. To reduce the potential for off-site movement from multiple fields, buffer zones from multiple application blocks must not overlap unless:

- *a minimum of 12 hours have elapsed from the time the earlier application(s) was complete until the start of the later application, and*
- *Fumigant Site Monitoring or Response Information for Neighbors (Emergency Preparedness and Response Measures), have been implemented if there are any residences or businesses within 300 ft (91.4 m) of any of the buffer zones.*

Emergency Preparedness and Response Measures

To reduce risks to people who may be near a buffer zone (e.g., at their home or working in a nearby field), EPA is requiring applicators to either provide on-site monitoring of the buffer zone perimeter in areas where residences and other occupied structures are within a specific

distance, or, as an alternative to on-site monitoring, provide emergency response information directly to neighbors. Whether measures are required depends on the size of the buffer zone and how close people may be to the buffer zone (Table 1). If the buffer zone is 25 ft (7.6 m), the minimum buffer zone size, then Emergency Preparedness and Response measures are not required. Also, if all of the land within 300 ft (91.4 m) of the edge of the buffer zone is under the control of the owner of the fumigated field, then Emergency Preparedness and Response measures are not required regardless of the size of the buffer zone.

The certified applicator must either follow directions under the Fumigant Site Monitoring section or follow the directions under the Response Information for Neighbors section. Fumigant Site Monitoring is only required if the Emergency Preparedness Response Measures are triggered and directions from the Response Information for Neighbors section are not followed. Response Information for Neighbors is only required if the Emergency Preparedness and Response Measures are triggered and directions from the Fumigant Site Monitoring section are not followed. Additionally, the emergency response plan stated in the Fumigant Management Plan (FMP) must be implemented immediately if a handler conducting the air monitoring experiences sensory irritation.

Buffer Zones For “Difficult-to-Evacuate” Sites

There are extra buffer zone restrictions for difficult to evacuate sites. Difficult to evacuate sites are pre-K to grade 12 schools, state licensed daycare centers, nursing homes, assisted living facilities, hospitals, in-patient clinics, and prisons.

If the buffer zone is greater than 300 ft (91.4 m), no fumigant application is permitted within ¼ mile/.4 km (1320 ft/402 m) unless the site is not occupied during application and next 36 hours.

If the buffer zone is less than 300 ft (91.4 m), no fumigant application is permitted within 1/8 mile/.2 km (660 ft/201 m) unless the site is not occupied during application and next 36 hours.

Conclusion

The EPA has created an online “Soil Fumigants Toolbox” full of valuable information. This paper offers some excerpts of information from the toolbox, especially the fact sheets on buffer zones and emergency preparedness. More information can be found at the toolbox’s website: http://www.epa.gov/pesticides/reregistration/soil_fumigants/.

Readers are encouraged to explore this resource for easy access to fact sheets, training materials, worker protection information, management plan templates, and other information for handling soil fumigants more safely.

Table 1: Site-specific proximity triggers for buffer zones greater than 25 feet (from USEPA b, p.1)

If the buffer zone is:	AND there are residences and businesses:
> 25 ft (7.6 m) and ≤ 100 ft (30.5 m)	50 ft (15.2 m) from the edge of the buffer zone
> 100 ft (30.5 m) and ≤ 200 ft (61 m)	100 ft (30.5 m) from the edge of the buffer zone
> 200 ft (61 m) and ≤ 300 ft (91.4 m)	200 ft (61 m) from the edge of the buffer zone
> 300 ft (91.4 m)	300 ft (91.4 m) from the edge of the buffer zone

Applicator must either:
 Monitor the air (option 1) or
 Provide information to neighbors (option 2)

References

Text for this paper was excerpted from:

- [USEPA, a] March 2012. Soil Fumigant Mitigation Fact Sheet: Buffer Zones. US Environmental Protection Agency Office of Pesticide Programs. URL: http://www.epa.gov/pesticides/reregistration/soil_fumigants/factsheets/sfm-buffer-zones-2012.pdf and <http://www.epa.gov/pesticides/reregistration/x-soil-fum-HOLD/buffer-zones-fs.htm> (accessed 8 Feb 2014).
- [USEPA, b] March 2012. Soil Fumigant Mitigation Fact Sheet: Emergency Preparedness and Response Requirements. US Environmental Protection Agency Office of Pesticide Programs. http://www.epa.gov/pesticides/reregistration/soil_fumigants/factsheets/sfm-emer-pre-2012.pdf (accessed 8 Feb 2014).
- [USEPA, c] December 2012. Pesticide News Story: Soil Fumigant Phase 2 Labels Take Effect. US Environmental Protection Agency Office of Pesticide Programs. URL: http://www.epa.gov/oppfead1/cb/csb_page/updates/2012/phase2-soilfumig.html (accessed 8 Feb 2014).
- [USEPA, d] March 2012. Implementating New Safety Measures for Soil Fumigant Pesticides. US Environmental Protection Agency Office of Pesticide Programs. URL: http://www.epa.gov/pesticides/reregistration/soil_fumigants/implementing-new-safety-measures.html (accessed 8 Feb 2014).

Understanding the Pathology of Douglas-fir Seedlings in Pacific Northwest Nurseries

Jerry Weiland

Jerry Weiland, Research Plant Pathologist, USDA-ARS, Horticultural Crops Research Laboratory, 3420 NW Orchard Ave, Corvallis, OR 97330; E-mail: Jerry.Weiland@ars.usda.gov.

Weiland J. 2014. Understanding the Pathology of Douglas-fir Seedlings in Pacific Northwest Nurseries. In: Wilkinson KM, Haase DL, Pinto JR, technical coordinators. National Proceedings: Forest and Conservation Nursery Associations—2013. Fort Collins (CO): USDA Forest Service, Rocky Mountain Research Station. Proceedings RMRS-P-72. 38-40. Available at: http://www.fs.fed.us/rm/pubs/rmrs_p072.html

Abstract: Douglas-fir seedlings are infected by a number of *Pythium* species causing damping-off and root rot. As soil fumigation continues to be more tightly regulated, knowledge about the identity and pathogenicity of *Pythium* species in forest nurseries will be increasingly important for studies that evaluate the effectiveness of nonfumigant disease control measures, including fungicide and biological control efficacy trials. The diversity of *Pythium* species at three Pacific Northwest (PNW) forest nurseries was evaluated and each nursery was found to have a unique assemblage of species. Furthermore, each *Pythium* species was found to cause a different level of disease on Douglas-fir seedlings. Subsequent fungicide and biological control efficacy studies found that differences in species responses to mefenoxam, fosetyl-AI, and *Streptomyces lydicus*, a biological control agent.

Key Words: *Pythium*, forest nursery, fungicide, biological control, *Streptomyces lydicus*, mefenoxam, fosetyl-AI

Introduction

Forest nurseries in the Pacific Northwest (PNW, states of ID, OR, and WA) are affected by a number of soilborne pathogens including *Pythium* species. However, there is limited information regarding the identity of *Pythium* species affecting seedling production or the amount of disease (damping-off, root lesions, and root rot) that each *Pythium* species can cause. Soilborne diseases are primarily managed by soil fumigation with a combination of methyl bromide and chloropicrin, or with dazomet (Weiland and others 2013a). Supplemental disease control is also provided with applications of mefenoxam or phosphonate fungicides (fosetyl-AI and phosphorous acid). However, soil fumigant use has become increasingly difficult with increasing state and federal regulation, and growers may need to increasingly rely on alternative disease control methods to obtain adequate disease control. Currently, it is unknown how *Pythium* species of PNW forest nurseries respond to two of the most commonly used fungicides, mefenoxam and fosetyl-AI. It is also unknown how the different *Pythium* species from forest nurseries respond to biological control agents. Our research objectives were therefore to: (1) evaluate *Pythium* species diversity in PNW forest nurseries; (2) determine the pathogenicity of different *Pythium* species on Douglas-fir seedlings; and, (3) evaluate the sensitivity of different *Pythium* species to mefenoxam, fosetyl-AI, and the biological control agent, *Streptomyces lydicus*. *Streptomyces lydicus* is a commercially available, antibiotic-producing bacterium that suppresses damping-off and root rot fungi, including *Pythium* species.

Materials and Methods

Pythium species were sampled from three forest nurseries (two in Oregon, one in Washington) by baiting soil samples with rhododendron leaf disks and Douglas-fir needles, and by dilution plating (Weiland 2011). Nursery A was located in southwestern Washington, Nurseries B and C were located in northwestern Oregon. Species were identified by morphology and by DNA sequence analyses. Sixteen *Pythium* species were then used to inoculate Douglas-fir seedlings in a greenhouse study (Weiland and others 2013b) with noninoculated seedlings used as a negative control. The number of seedlings that were killed and the number of seedlings with root lesions were then recorded for each species tested. Species of *P. irregulare*, *P. sylvaticum*, and *P. ultimum* were also tested against concentrations of mefenoxam (0.1-100 µg/ml) and fosetyl-Al (1-2500 µg/ml) on fungicide-amended V8 media in petri plates. The effective concentration of each fungicide required to reduce diameter growth by 50% (EC50) was calculated and compared among the three species to determine their sensitivity to each fungicide. Finally, inhibition of 16 *Pythium* species was measured in dual-culture plates containing *Streptomyces lydicus* strain WYEC 108. The minimum distance at which the growth of the *Pythium* isolate towards the *S. lydicus* culture stopped (inhibition zone distance) was recorded and used to determine the sensitivity of each *Pythium* species to the biological control agent.

Results and Discussion

Nineteen *Pythium* species were identified from the three forest nurseries, of which at least eleven had not been previously been described

from forest nursery soils (table 1). Each nursery was associated with a different community of *Pythium* species, with *P. irregulare* the most common species at nursery A, *P. 'vipa'* the most common at nursery B, and *P. dissotocum* the most common at nursery C (table 1).

Each of the 16 *Pythium* species tested was able to cause disease (figure 1). Eight species (*P. mamillatum*, *P. rostratiformis*, *P. aff. oopapillum*, *P. dissotocum*, *P. sylvaticum*, *P. ultimum*, *P. aff. macrosporum*, and *P. irregulare*) reduced survival of Douglas-fir seedlings by at least 25% and were considered highly virulent (aggressive) species. Although the remaining species reduced seedling survival by less than 25%, these species did cause significantly more root lesions than were observed on the noninoculated seedlings, and were therefore considered weakly virulent species.

In the fungicide and biological control sensitivity studies, isolates of *P. irregulare* were generally found to be less sensitive to mefenoxam than isolates of either *P. sylvaticum* or *P. ultimum* (0.02 µg/ml for *P. irregulare* versus 0.06 µg/ml for both *P. sylvaticum* and *P. ultimum*). However, two isolates of *P. ultimum* (one each from nursery B and C) were found that were 5000-6000 times more resistant to mefenoxam than any of the other isolates tested. No differences were observed in the sensitivity of *P. irregulare*, *P. sylvaticum*, or *P. ultimum* isolates to fosetyl-Al (1256-1508 µg/ml). Finally, *Pythium* species were also found to vary in sensitivity to the biological control agent *Streptomyces lydicus*. Inhibition ranged from 17 mm (*P. aff. oopapillum*) up to 34 mm (*P. aff. mercuriale*).

The diversity of *Pythium* species in forest nursery soils was much greater than previously characterized (Hansen and others 1990, James 2002) and was observed to vary from nursery to nursery. This diversity is reflected in the ability of individual species to cause disease and to be controlled by fungicides and biological control agents.

Table 1. Frequency of *Pythium* species from soil at three forest nurseries.

Species	Nursery A (WA)	Nursery B (OR)	Nursery C (OR)	Total
<i>P. aphanidermatum</i>	0	0	1	1
<i>P. aff. attrantheridium</i>	1	1	0	2
<i>P. dissotocum</i>	6	0	140	146
<i>P. irregulare</i>	194	29	17	240
<i>P. irregulare</i> group III	17	0	0	17
<i>P. irregulare</i> group IV	2	10	0	12
<i>P. aff. macrosporum</i>	19	46	20	85
<i>P. mamillatum</i>	3	0	7	10
<i>P. aff. mercuriale</i>	0	0	1	1
<i>P. middletonii</i>	3	0	0	3
<i>P. aff. oopapillum</i>	0	0	2	2
<i>P. pachycaule</i>	1	1	0	2
<i>P. rostratiformis</i>	2	1	0	3
<i>P. aff. rostratum</i>	0	0	2	2
<i>P. aff. spiculum</i>	16	2	33	51
<i>P. sylvaticum</i>	0	27	25	52
<i>P. torulosum</i>	31	0	10	41
<i>P. ultimum</i>	2	23	41	66
<i>P. 'vipa'</i>	3	160	1	164
Total isolates	300	300	300	900
Total species	14	10	13	19

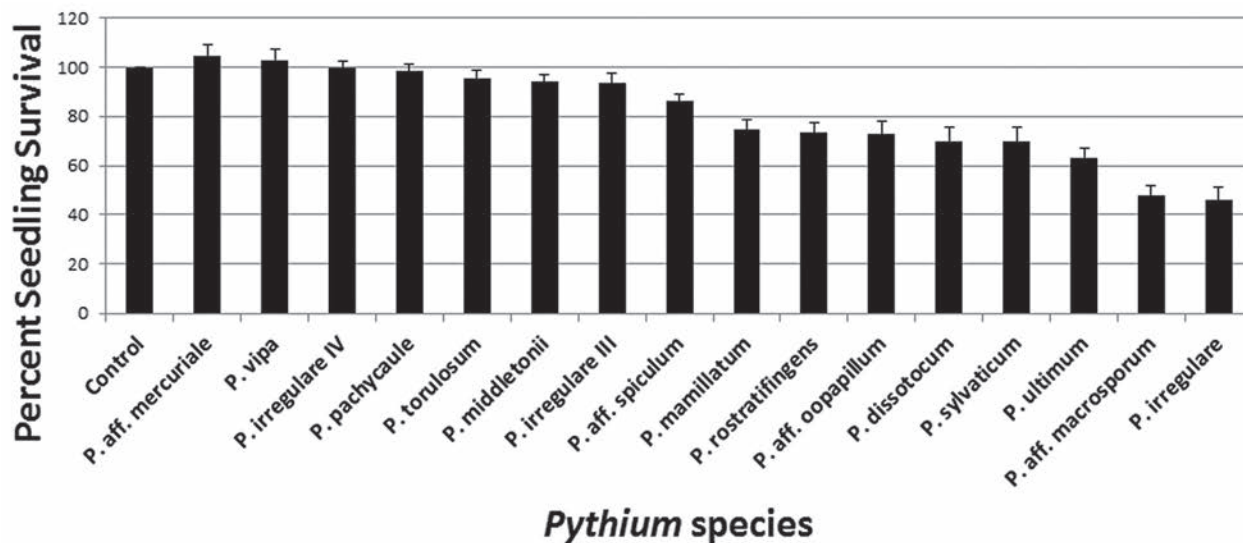

Figure 1. Percent survival of seedlings inoculated with 16 different *Pythium* species.

Summary

Many *Pythium* species are found in PNW forest nurseries and each nursery has a unique assemblage of species. In turn, each *Pythium* species causes a different amount of disease to Douglas-fir seedlings. As a consequence, the amount of *Pythium* damping-off at each nursery will likely be influenced by the predominant *Pythium* species that occur at each nursery. Nurseries with high populations of aggressive *Pythium* species would be expected to experience more damage than those with mostly weakly-pathogenic *Pythium* species. In addition, *Pythium* species vary in sensitivity to mefenoxam and *S. lydicus*, but not to fosetyl-AI. As regulations and costs associated with soil fumigation continue to increase, emphasis will need to be placed on integrated pest management practices that target multiple soilborne pathogen species.

References

- Hansen, EM, Myrold DD, Hamm PB. 1990. Effects of soil fumigation and cover crops on potential pathogens, microbial activity, nitrogen availability, and seedling quality in conifer nurseries. *Phytopathology* 80: 698-704.
- James RL. 2002. Effects of spring applications of dazomet on root diseases and performance of Douglas-fir and western white pine transplants. USDA Forest Service Nursery, Coeur d'Alene, Idaho. Forest Health Protection Report 02-9.
- Weiland JE. 2011. Influence of isolation method on recovery of *Pythium* species from forest nursery soils in Oregon and Washington. *Plant Disease* 95: 547-553.
- Weiland JE, Littke WR, Haase DL. 2013a. Forest nurseries face critical choices with the loss of methyl bromide fumigation. *California Agriculture* 67: 153-161.
- Weiland JE, Beck BR, Davis A. 2013b. Pathogenicity and virulence of *Pythium* species obtained from forest nursery soils on Douglas-fir seedlings. *Plant Disease* 97: 744-748.

Effect of Nursery Photoperiod Manipulation on Coastal Douglas-fir Seedling Root Development Following Planting

Douglass F Jacobs

Douglass F Jacobs is the Fred M. van Eck Professor of Forest Biology with the Hardwood Tree Improvement and Regeneration Center, Department of Forestry and Natural Resources, Purdue University, West Lafayette, IN 47907; E-mail: djacobs@purdue.edu

Jacobs DF. 2014. Effect of Nursery Photoperiod Manipulation on Coastal Douglas-fir Seedling Root Development Following Planting. In: Wilkinson KM, Haase DL, Pinto JR, technical coordinators. National Proceedings: Forest and Conservation Nursery Associations—2013. Fort Collins (CO): USDA Forest Service, Rocky Mountain Research Station. Proceedings RMRS-P-72. 41-43. Available at: http://www.fs.fed.us/rm/pubs/rmrs_p072.html

Abstract: Photoperiod manipulation (i.e., short-day treatments or blackout) is used by nurseries in northern latitudes when growing spruce and pine, as a means to arrest shoot growth, encourage high root to shoot ratios, and induce dormancy. Effects on coastal Douglas-fir (*Pseudotsuga menziesii* var. *menziesii* [Mirb.] Franco) are less well known, especially for provenances of lower latitudes (i.e., <45 °N). Additionally, transplant rooting responses of short-day treated seedlings at relatively cold temperatures (i.e., <10 °C [50 °F]), which characterize many outplanting sites during winter/early-spring planting, have not been well studied. Recent research suggests that nursery short-day treatment has a pronounced effect on seedling development in coastal Douglas-fir, and phenological effects may carry over through spring de-hardening. Additionally, collective evidence from the limited studies examining transplant rooting responses across a range of soil temperature suggest that short-day treated seedlings produce more roots at low soil temperatures. This implicates potential for reduced transplanting stress of short-day treated seedlings on sites characterized by low soil temperatures and/or drought. Future research should examine rooting responses across a range of soil temperatures that might be encountered throughout an entire growing season. Additionally, specific prescriptions for timing of short-day treatments should be developed that will aid in coupling of physiological status to site conditions under a range of site conditions and silvicultural prescriptions, including fall planting.

Key Words: Blackout, short-day treatment, cold hardiness, plantation establishment, nursery propagation, root growth, seedling quality

Introduction

Photoperiod manipulation during propagation (i.e., short-day treatments or blackout) is increasingly used by forest tree nurseries in northern latitudes to slow growth in conifer seedlings and induce dormancy (Hawkins and others 1996; Turner and Mitchell 2003). The premise is that short-day treatments help to avert excess shoot growth leading to a higher (more desirable) root to shoot ratio, while simultaneously increasing seedling cold hardiness (and corresponding stress resistance). While use of photoperiod manipulation in operation has mainly been confined to spruce and pine in northern climates, this practice has recently been explored in coastal Douglas-fir (*Pseudotsuga menziesii* var. *menziesii* [Mirb.] Franco) (Turner and Mitchell 2003; MacDonald and Owens 2006; Jacobs and others 2008) and shown to affect seedling dormancy status at relatively low (i.e., <45 °N) latitudes (Jacobs and others 2008). There is currently some debate among nursery managers, however, as to whether photoperiod manipulation is beneficial for culture of coastal Douglas-fir; this is mainly related to the possibility that root growth following planting could be negatively affected. This paper summarizes some of the results and corresponding discussion published in Jacobs and others (2008) about the effects of short-day treatments on coastal Douglas-fir seedling dehardening and root growth following transplant into varying rhizosphere temperatures. The reader is directed to this paper for more detailed descriptions of study methodology and a more thorough synthesis of results within the existing scientific literature. Some recommendations for future research in this area are provided.

Photoperiod Manipulation and Seedling Phenology

Seedling phenology is regulated by photoperiod in many temperate species; cold hardiness development is initiated by photoperiod reduction and coincides with growth cessation. Short-day treatment consistently induces early bud set during nursery culture, but can also result in earlier budbreak after outplanting (Hawkins and others 1996; Turner and Mitchell 2003), indicating that phenological and physiological impacts of photoperiod manipulation persist through winter cold storage and into the early stages of seedling establishment. Jacobs and others (2008) confirmed this pattern as they reported that short-day treated Douglas-fir seedlings generally had greater cold tolerance than ambient (long-day) treated seedlings after removal from freezer storage at periodic sampling points between January through May. Root growth capacity is strongly related to the bud dormancy cycle (Ritchie and Dunlap 1980), and so short-day treatments during nursery culture could affect timing and vigor of subsequent root growth.

Photoperiod Manipulation and Transplant Root Growth

Vigorous root development following field planting is necessary to minimize potential for seedling physiological drought and ensure survival (Grossnickle 2005). Root growth of newly planting conifers is optimized at around 20 °C (68 °F) soil temperature (Lopushinsky and Max 1990), but soil temperature on most temperate outplanting during winter or early spring is usually relatively cold (i.e., <10 °C [50 °F]). Thus, soil temperature is an important consideration when examining

potential for new root growth immediately following planting. However, the interaction between soil temperature and seedling dormancy status and its affect on new root growth is a relatively unexplored area of research. Turner and Mitchell (2003) reported that root growth capacity was reduced for Douglas-fir seedlings with earlier vs. later short-day treatment initiation date, but they included no long-day treatment and soil temperature was not reported. MacDonald and Owens (2006) found that short-day treatment did not affect Douglas-fir seedling root growth capacity after transplant into pots, but they used a constant air temperature of 20 °C (68 °F) and soil temperature was again not reported. Hawkins and Shewan (2000), studying interior spruce seedlings, showed that short-day treatments resulted in less new roots than long-day treatment following transplant into hydroponics for 7 days, but they only examined a root zone temperature of 20 °C (68 °F).

In Jacobs and others (2008), Douglas-fir seedlings that were either short-day or ambient (long-day) treated during the latter part of the growing season were lifted from storage at five different sampling dates (January-May) and transplanted into hydroponic root zone temperatures of 10, 15, 20, and 25 °C (50, 59, 68, and 77 °F) in a controlled growth room environment. Numbers and biomass of new roots (figure 1) were sampled at the end of each 4-week treatment period. A photoperiod by root temperature interaction occurred, with no effect of sampling date. Short-day treated seedlings had more new roots at 10 °C (50 °F), but the opposite effect occurred for both new roots and new root dry mass at 20 °C (68 °F).

Grossnickle and others (1991a) is the only other known published report to examine transplant rooting response of short-day cultured seedlings under more than one root temperature regime. They examined photoperiod responses of western hemlock seedlings in combination with abbreviated or long watering regimes on transplant rooting in hydroponics at 5 and 22 °C (41 and 72 °F) root zone temperatures for



Figure 1. Experimental Douglas-fir seedlings showing new root development following growth in a hydroponic system under controlled root zone temperatures.

14 days and found similar responses to Jacobs and others (2008). In a complementary field trial, Grossnickle and others (1991b) reported that short-day treated seedlings had increased root proliferation 1 month following planting. Better adaptability of short-day treated seedlings to low root zone temperatures was likely due to greater seedling stress resistance and decreased resistance to water movement at low soil temperatures (Grossnickle and others 1991a,b; Jacobs and others 2008). This evidence suggests greater water flow efficiency for short-day treated seedlings immediately after early-spring planting when soil temperatures are still low and, therefore, potential for reduced transplanting stress.

Conclusions and Future Directions

Short-day treatment in the nursery has a large effect on seedling morphology and physiology and although this practice has been applied mainly to species and provenances of higher latitudes, it is also relevant to more southerly seed sources of some species (e.g., coastal Douglas-fir). Increased cold tolerance characteristic of short-day treated seedlings in fall apparently may be maintained through spring. The limited research evaluating transplant rooting response of short-day treated seedlings suggests that these seedlings should be targeted for sites where low soil temperature is expected immediately after planting.

There are many unanswered questions remaining regarding effects of photoperiod manipulation on seedling development, especially for southerly sources and species adapted to mild climates such as coastal Douglas-fir. One example is:

Rooting responses associated with the timing of short-day treatments in relation to natural growth rhythms (Fløistad 2002). In other words, how can we adjust the starting and ending points of short-day treatments, as well as their duration within (i.e., number of daylength hours) to optimize seedling development for given species and provenances?

A need also exists to identify trends in root growth at different soil temperatures throughout the growing season (Iivonen and others 2001). The few studies that have examined transplant rooting responses at varying temperatures have done so over very short time periods (i.e., several weeks). It would be useful to know if trends in root growth for short-day treated seedlings vary as soil warms throughout the growing season and into fall.

Finally, as interest continues to grow in planting beyond the traditional winter/spring period, it would be valuable to examine transplant rooting responses of short-day treated seedlings during fall to aid in coupling of physiological status to site conditions for fall planting.

Acknowledgments

I appreciate funding support from the Sierra Cascade Intensive Forest Management Cooperative and the Hardwood Tree Improvement and Regeneration Center. Tom Jopson at Cal Forest Nursery provided important recommendations and helped to coordinate treatment installations and shipping of samples. Anthony Davis, Diane Haase, Nabil Khadduri, Mike Taylor, and John Trobaugh all provided excellent input in developing this presentation and paper.

References

- Fløistad IS. 2002. Effects of excessive nutrient supply and short day treatment on autumn frost hardiness and time of bud break in *Picea abies* seedlings. *Scan. J. For. Res.* 17:295-303.
- Hawkins CDB, Shewan KB. 2000. Frost hardiness, height, and dormancy of 15 short-day, nursery treated interior spruce seed lots. *Can. J. For. Res.* 30:1096-1105.
- Hawkins CDB, Eastham AM, Story TL, Eng RYN, Draper DA. 1996. The effect of nursery blackout application on Sitka spruce seedlings. *Can. J. For. Res.* 26:2201-2213.
- Grossnickle SC. 2005. Importance of root growth in overcoming planting stress. *New For.* 30:273-294.
- Grossnickle SC, Arnott JT, Major JE, Tschaplinski TJ. 1991a. Influence of dormancy induction treatments on western hemlock seedlings. I. Seedling development and stock quality assessment. *Can. J. For. Res.* 21:164-174.
- Grossnickle SC, Arnott JT, Major JE. 1991b. Influence of dormancy induction treatments on western hemlock seedlings. I. Physiological and morphological response during the first growing season on a reforestation site. *Can. J. For. Res.* 21:175-185.
- Iivonen S, Rikala R, Vapaavuori E. 2001. Seasonal root growth of Scots pine seedlings in relation to shoot phenology, carbohydrate status, and nutrient supply. *Can. J. For. Res.* 31:1569-1578.
- Jacobs DF, Davis AS, Wilson BC, Dumroese RK, Goodman RC, Salifu KF. 2008. Short-day treatment alters Douglas-fir seedling dehardening and transplant root proliferation at varying rhizosphere temperatures. *Canadian Journal of Forest Research* 38:1526-1535.
- Lopushinsky W, Max TA. 1990. Effect of soil temperature on root and shoot growth and on budburst timing in conifer seedling transplants. *New For.* 4:107-124.
- MacDonald JE, Owens JN. 2006. Morphology, physiology, survival, and field performance of containerized coastal Douglas-fir seedlings given different dormancy-inducing regimes. *HortSci.* 41:1416-1420.
- Ritchie GA, Dunlap JR. 1980. Root growth potential: its development and expression in forest tree seedlings. *New Zeal. J. For. Sci.* 10:218-248.
- Turner J, Mitchell SJ. 2003. The effect of short day treatments on containerized Douglas-fir morphology, physiology and phenology. *New For.* 26:279-295.

Quantification of *Fusarium commune* in Douglas-fir Seedling Nurseries

Anna Leon

Anna Leon, Doctoral Candidate, Department of Plant Pathology, Washington State University Puyallup Research and Extension Center, 26-06 West Pioneer, Puyallup, WA 98403; E-mail: anna_leon@wsu.edu

Leon A. Quantification of *Fusarium commune* in Douglas-fir Seedling Nurseries. In: Wilkinson KM, Haase DL, Pinto JR, technical coordinators. National Proceedings: Forest and Conservation Nursery Associations—2013. Fort Collins (CO): USDA Forest Service, Rocky Mountain Research Station. Proceedings RMRS-P-72. 44-49. Available at: http://www.fs.fed.us/rm/pubs/rmrs_p072.html

Abstract: A better diagnostic assay can help growers make cost effective management decisions that meet environmental regulations. A quantitative real-time polymerase chain reaction (qPCR) assay has been developed for both *Fusarium commune* and *Fusarium oxysporum* isolated from inoculated soil, with the intent of quantifying *F. commune* from naturally occurring populations in nursery soil. *F. commune* inoculated in greenhouse potting soil (CFU/g) positively correlated with the observed Ct values from the duplex qPCR assay. Additionally, greenhouse trials show a positive correlation between inoculum addition and disease development at high levels of inoculation. Additional trials are being done.

Key Words: disease diagnosis, quantitative real-time polymerase chain reaction (qPCR), molecular diagnostic assays, dilution plating

Introduction

Fusarium root rot and damping off has been an economically important disease of Douglas-fir seedlings in production nurseries for several decades. It was long believed that *Fusarium oxysporum* consisted of both virulent and non-virulent forms (Bloomberg 1966; Bloomberg 1971), but recent molecular work suggests that the morphologically indistinguishable species *Fusarium commune* is the virulent pathogen of interest (Skovgaard and others 2003; Stewart and others 2006). Diagnosis of *F. oxysporum* was typically done by counting colonies plated from soil dilutions based on colony morphology. Given the unreliable diagnostic nature of morphological characters, current determinations of soil *Fusarium* concentrations likely do not correlate with actual levels of disease. Given the difficulties with proper diagnosis and quantification of *Fusarium* disease in nurseries, no accurate method exists to test to see if fumigation or other disease control practices need to be used. A better diagnostic assay can help growers make cost effective management decisions that meet environmental regulations

Molecular diagnostic assays have been used with success in other cropping systems. Real-time polymerase chain reaction (qPCR) amplifies DNA and can be used to quantify the initial amount of DNA in a sample if run with a standard set of isolates at known concentrations. This technology has been used to determine quantities of pathogenic organisms in field soil, in plant tissue and in storage facilities (Schroeder and others 2006; Okubara and others 2008; Zhang and others 2005).

The primary objective of this study is to develop a quantitative real-time qPCR assay for the identification and quantification of *F. commune*. It is essential that this assay be able to differentiate between *F. commune* and *F. oxysporum* soil DNA. A complementary disease threshold assay is being developed to determine the levels at which growers need to be concerned about *F. commune* and also is being used as a way to make the qPCR assay more robust.

Materials and Methods

Soil Sampling and Dilution Plating

Soil samples were collected with approval and assistance from nursery staff at three Washington nurseries and one Oregon nursery in 2011 and 2012. Thirty soil samples were taken from each field sampled with a 12-inch soil corer. Each sample was a composite of 10 core samples mixed together at each location in the field.

Soil samples were allowed to air dry at room temperature to remove excess moisture. Samples with large aggregate particles were ground with a mortar and pestle prior to testing. Three replicate soil samples were taken from the sample for dilution plating on Komada's media (Komada 1975) as described in the protocol of Leslie and Summerell (2006). The remainder was kept in the cooler at 37 °C for short term storage. *Fusarium* colonies growing on Komada's media were counted and colony forming units per gram (CFU/g) were calculated using an adjusted soil dry weight.

DNA Extraction and qPCR Development

DNA was extracted from single spore inoculated *Fusarium* cultures on PDA plates using a Qiagen DNeasy Plant Mini Kit following the Plant Tissue Mini Protocol (Qiagen 2006). Samples taken from scrapings off of PDA agar plates were lysed using the FastPrep-24 Tissue Homogenizer and the Qiagen protocol was started with the homogenized material at Step 7. The procedure for PCR was adapted from the standard protocol in the WSU Molecular Lab. One aliquot master mix contained 32.9 µl dH₂O, 5 µl 10X PCR buffer (+MgCl), 0.5 µl 10X µM dNTPs, 2.5 µl 10 µM EF-1α forward primer, 2.5 µl 10 µM EF-1α reverse primer, 5 µl 10 mg/mL BSA, and 0.6 µl Taq Polymerase (3 units). 1 µl extracted DNA was added to the master mix. The primers used were the EF1 forward primer: ATGGGTAAGGARGACAAGAC and the EF2 reverse primer: GGARGTACCAGTSATCATGTT. The PCR protocol was as follows: 94 °C for 2 minutes; 30 cycles of 94 °C for 1 minute, 54 °C for 30 seconds, 72 °C for 1 minute; 72 °C for 10 minutes. The PCR product was run on a 1% agarose gel to verify the amplification of DNA prior to sequencing. 5 µl PCR product was combined with 2 µl ExoSAP-IT and the ExoSAP protocol was run. After clean-up, samples were sent to Genewiz for sequencing. Returned sequences were examined for fidelity using Finch TV and compared to existing DNA sequences using a BLAST search. Isolate identity was confirmed and sequences were compared using BioEdit software.

A TaqMan primer and probe in the EF-1α region were developed using PrimerSelect software from known *F. oxysporum* and *F. commune* isolates. The working protocol designed for this region for *F. commune* isolates uses forward primer: GACGGGCGCGTTTGC, reverse primer: ACGTGACGATGCGCTCATT and 6-FAM labeled TaqMan MGB probe: CTCCCATTTCACAACC labeled with a non-fluorescent quencher. The protocol designed for *F. oxysporum* isolates uses forward primer: GGGAGCGTTGCCCTCTTA, reverse primer: ACACGTGACGACGCACTCAT, and a 6-FAM labeled TaqMan MGB probe: CCATTTCACAACCTC labeled with a non-fluorescent quencher. These primer/probes will be tested on isolates identified using traditional PCR in the EF-1α region. Sequence information from isolates of *F. commune* and *F. oxysporum* were used in the development of these primer/probe sets (Stewart and others 2006).

The qPCR technique was verified using pure DNA extracted from cultures of *F. oxysporum* and *F. commune*. Extracted DNA was diluted in 5 concentrations ranging from 10⁻¹ to 10⁻⁵. 2 µl of diluted DNA were added to the master mix containing: 12.5 µl 2X TaqMan, 1.25 µl 2 µM forward primer, 1.25 µl 2 µM reverse primer, 1.25 µl 2

µM probe, 2.3 µl trehalose, and 4.5 µl H₂O for a total 25 µl reaction. An Applied Biosystems 7500 Real Time PCR System was used for all qPCR. The standard protocol was followed: stage 1 - 50.0 °C for 2:00 min, stage 2 - 95.0 °C for 10:00, stage 3 - 40 replications at 95.0 °C for 15 sec, final stage - 60.0 °C for 1:00 min. This procedure was used for both the *F. oxysporum* and *F. commune* protocols. Each sample was tested using both of the protocols in the same reaction. All reactions included the addition of the TaqMan Exogenous Internal Positive Control Reagents with a VIC probe to ensure negative readings represented a lack of sequence similarity rather than the presence of DNA inhibition.

Ct values for each sample were compared to a standard curve for each respective species. A relationship between the dilutions was established. Individual samples were judged based on their amplification and threshold value for each of the primer/probe protocols. Results were compared to the original BLAST sequence information on the samples.

After successful completion of the two qPCR assays for each individual species, a triplex reaction was designed to increase efficiency. The same primer and probe sequences in the individual reactions were used, but different fluorescent dyes and quenchers were applied to the probes, as well as to a salmon sperm probe to be used as an internal positive control (SKETA). When first designed, *F. commune* was given a 6-FAM dye and *F. oxysporum* a NED dye, both with Applied Biosystems MGB quenchers. The SKETA probe was given a VIC dye with a TAMRA fluorescent quencher. The TAMRA quencher from the SKETA probe and the NED dye in the *F. oxysporum* probe had a negative reaction and the SKETA probe was redesigned with a VIC fluorescent dye and a MGB quencher. Applied Biosystems technology was used to ensure optimum efficacy on our machine.

Greenhouse Threshold Trial and Soil DNA Extractions

Three isolates of *F. commune* and three isolates of *F. oxysporum* were selected based on a combination of pathogenicity and isolate viability in a preliminary trial. Ground cornmeal-perlite inoculum samples were combined at five different inoculum levels. 3 cubic feet of Specialty Soils, Inc. Gardener's Professional Secret growing media (Covington, WA) was sterilized in a Pro-Grow Electric Soil Sterilizer, Model #SST-15 (Pro-Grow Supply, Brookfield, WI) at 180 °C. The inoculum was mixed with sterilized growing media on a w/w basis at 1:50, 1:500, 1:5000, 1:25000, and 1:50000 (Treatments 1-5 respectively). Ten seeds were planted in treatment media in 3.25 in X 3.25 in. (8.25 cm X 8.25 cm) pots and treatments were randomly arranged in five replicated blocks. Greenhouse temperatures were kept between 24-27 °C (75.2-80.6 °F) with 18 hours of daylight. Pots were watered using overhead sprinklers for 5 minutes, 4 times a day.

Fusarium DNA from the potting mix material was extracted using the Wizard Magnetic DNA Purification System for Food as described for *Rhizoctonia solani* in Budge and others (2009). The manufacturer protocol 3.A. was followed with the exception of steps 1 and 2, which call for the use of Lysis Buffer A and RNaseA. Instead, 4 grams of soil were combined with 5 mL of glass beads in a 50 mL plastic tube. A soil extraction buffer was prepared as described in Budge and others (2009): 120 mM sodium phosphate buffer pH8, 2% CTAB, 5 M NaCl, 2% antifoam B emulsion. 16 mL of the soil extraction buffer were added to the 50 mL plastic tube and homogenized in the Fast Prep Homogenizer at setting 6.5 for 60 seconds. After homogenization, tubes were centrifuged for 3 minutes at 2000 g. 500 µl were pipetted into a 2.0 mL tube and all instructions from Step 3 of the manufacturer's 3.A. protocol were followed.

Results and Discussion

Development of two separate qPCR assay for identification of *Fusarium commune* from *Fusarium oxysporum* has been successful. The efficiency of the standard curves for the qPCR assays for *F. commune* and *F. oxysporum* were 0.9741 and 0.9766 respectively (figure 1). The new multiplex assay is currently showing similar results with efficiencies of 0.9781 and 0.9897 for the standard curves of *F. commune* and *F. oxysporum*, respectively (figure 2).

Using the separate, individual qPCR assays, the Ct value of the qPCR for *F. commune* and *F. oxysporum* correlated with the inoculum expressed in colony forming units/g (CFU/g) with $r^2 = 0.825$ and 0.789 respectively (figure 3). Mortality and inoculum expressed as CFU/g formed positive correlations for three *F. commune* isolates, with $r^2 = 0.7211$, 0.8358 , and 0.9376 and for two *F. oxysporum* isolates, with $r^2 = 0.8275$ and 0.8954 (figure 4). Subsequent greenhouse assays are currently being run at lower inoculum concentrations to further test the sensitivity of the qPCR assay and how seedlings respond to lower levels of disease.

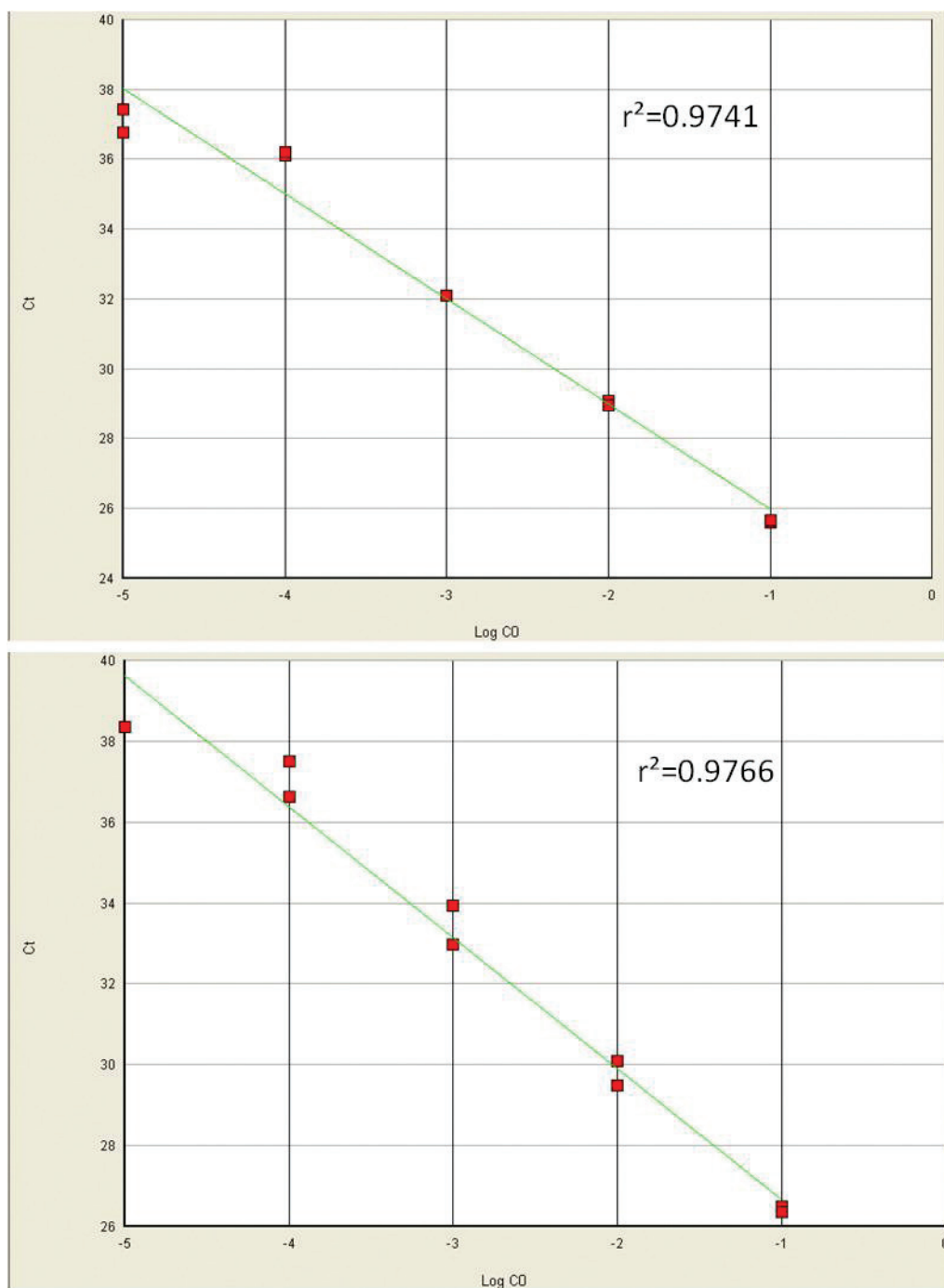

Figure 1. qPCR standard curve efficiency for *F. commune* and *F. oxysporum* single assays.

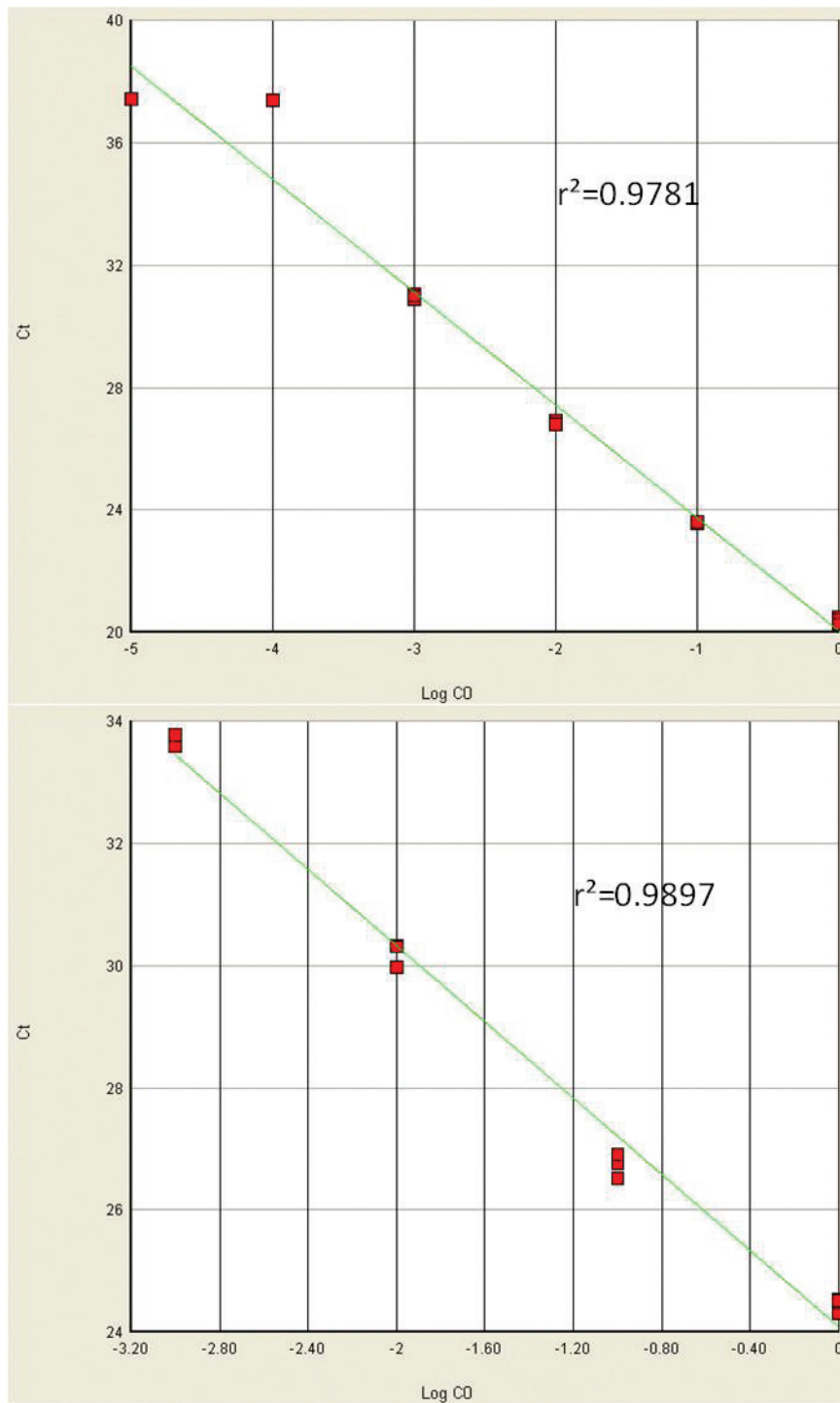

Figure 2. qPCR standard curve efficiency for *F. commune* and *F. oxysporum* multiplex assay.

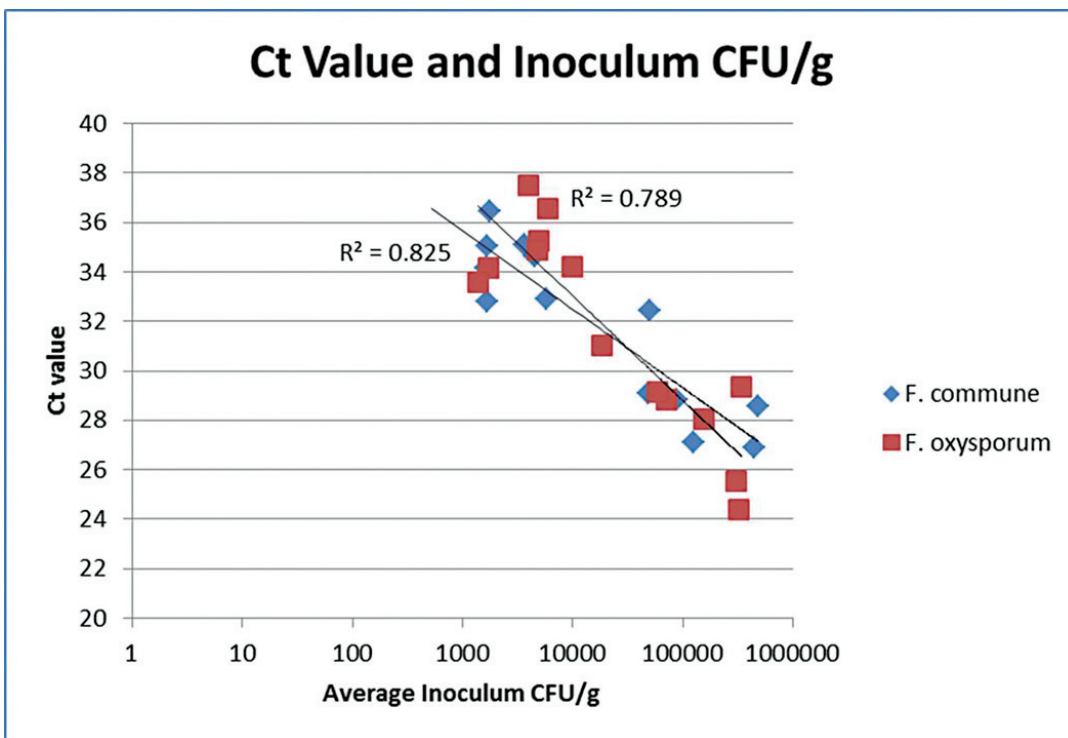

Figure 3. Correlation between observed qPCR Ct value and average inoculum concentration (CFU/g) of soil inoculated with *F. commune* and *F. oxysporum*.

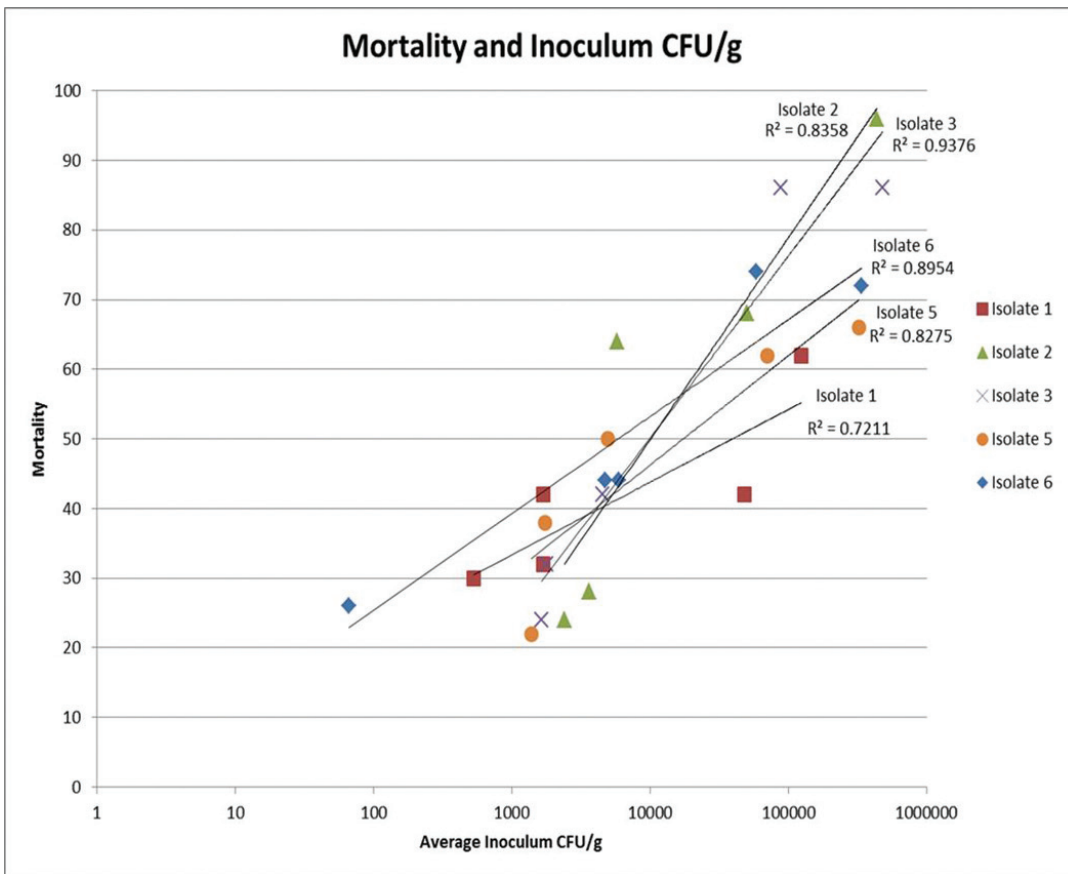

Figure 4. Correlation observed between percent Douglas-fir damping off and average inoculum concentration (CFU/g) of soil inoculated with three isolates of *F. commune* (Isolate 1-3) and two isolates of *F. oxysporum* (isolates 5-6).

A qPCR assay that is able to differentiate between *F. oxysporum* and *F. commune* will give growers a new method to test soil for pathogenic properties prior to fumigation or planting. Molecular identification allows the quantification of *Fusaria* in forest nursery soils, just as other pathogens have been quantified in other cropping systems. For example, researchers have recently developed a qPCR assay for the quantification of *C. destructans* f. sp. *panacis* in ginseng fields (Kernaghan and others 2007). *C. destructans* is also a Douglas-fir pathogen often found in nurseries infected with *F. commune*. Testing an assay for *Cylindrocarpon* on forest nursery soils and multiplexing it with the *F. commune* assay may provide a more thorough disease assay. Future research may also move into more advanced technologies such as next generation sequencing. Pyrosequencing allows for the testing of all soil microorganisms in a single assay. Detection of *Phytophthora* species in Italian chestnut forest soil sites using a pyrosequencing assay was more sensitive than traditional baiting (Vannini and others 2013). A similar technique may be able to determine different species of *Fusarium* and other bacterial and fungal species present in forest nursery soil. This technology is primarily used to provide relative rather than quantitative information, but can provide a helpful suite of information when making management decisions.

Summary

Preliminary data from this study suggest that the qPCR assay will be a valuable tool for quantifying *F. commune* independent from *F. oxysporum*. Additionally, this work will help establish targeted soil disease levels for fungicide and fumigant treatment. It will provide growers with an additional tool when making soil treatment decisions, potentially saving money and reducing the nursery's environmental impact.

References

- Bloomberg WJ. 1966. The occurrence of endophytic fungi in Douglas-fir seedlings and seed. *Canadian Journal of Botany* 44: 413-420.
- Bloomberg WJ. 1971. Disease of Douglas-fir seedlings caused by *Fusarium oxysporum*. *Phytopathology* 61: 467-470.
- Budge GE, Shaw MW, Colyer A, Pietravalle S, Boonham N. 2009. Molecular tools to investigate *Rhizoctonia solani* distribution in soil. *Plant Pathology* 58: 1071-1080.
- Kernaghan G, Reeleder RD, Hoke SMT. 2007. Quantification of *Cylindrocarpon destructans* f. sp. *Panacis* in soils by real-time PCR. *Plant Pathology* 56: 508-516.
- Komada H. 1975. Development of a selective medium for quantitative isolation of *Fusarium oxysporum* from natural soil. *Review of Plant Protection Research* 8: 114-125.
- Leslie JF, Summerell BA. 2006. *The Fusarium laboratory manual*. Ames, Iowa: Blackwell Publishing.
- Okubara PA, Schroeder KL, Paulitz TC. 2008. Identification and quantification of *Rhizoctonia solani* and *R. oryzae* using real-time polymerase chain reaction. *Phytopathology* 98: 837-847.
- Schroeder KL, Okubara PA, Tambong JT, Lévesque CA, Paulitz TC. 2006. Identification and quantification of pathogenic *Pythium* spp. from soils in Eastern Washington using real-time polymerase chain reaction. *Phytopathology* 96: 637-647.
- Skovgaard K, O'Donnell K, Nirenberg HI. 2003. *Fusarium commune* is a new species identified by morphological and molecular phylogenetic data. *Mycologia* 95(4): 630-636.
- Stewart JE, Kim MS, James RL, Dumroese RK, Klopfenstein NB. 2006. Molecular characterization of *Fusarium oxysporum* and *Fusarium commune* isolates from a conifer nursery. *Phytopathology* 96: 1124-1133.
- Vannini A, Bruni N, Tomassini A, Franceschini S, Vettraino AM. 2013. Pyrosequencing of environmental soil samples reveals biodiversity of the *Phytophthora* resident community in chestnut forests. *FEMS Microbiology Ecology* 85: 433-442.
- Zhang A, Zhang J, Wang, Y, Zheng X. 2005. Molecular detection of *Fusarium oxysporum* f. sp. *niveumi* and *Mycosphaerella melonis* in infected plant tissues and soil. *FEMS Microbiology Letters* 249: 39-47.

Evaluating Alternative Growing Media Components

Richard P Regan

Richard P Regan, Associate Professor, Department of Horticulture, 4017 Agriculture and Life Sciences Building, Oregon State University, Corvallis, OR 97331-7304; Email: rich.regan@oregonstate.edu

Regan RP. 2014. Evaluating Alternative Growing Media Components. In: Wilkinson KM, Haase DL, Pinto JR, technical coordinators. National Proceedings: Forest and Conservation Nursery Associations—2013. Fort Collins (CO): USDA Forest Service, Rocky Mountain Research Station. Proceedings RMRS-P-72. 50-53. Available at: http://www.fs.fed.us/rm/pubs/rmrs_p072.html

Abstract: Alternative components for soilless container media are continually being evaluated to improve or replace existing materials. These alternative materials are often mixed with other components to provide forest and conservation nurseries with a high quality media. Nursery managers should follow a process to evaluate new materials to avoid causing losses due to unacceptable plant growth and development. A desirable growing media is non-toxic to plants, provides a reservoir for water, allows oxygen and gas exchange for roots, retains nutrients for uptake, and provides anchorage for the plants. It should also be available and cost-effective, while matching the nursery production system. This paper explores this process and offers suggestions on evaluating the desired properties of container media.

Key Words: nursery, Douglas-fir bark, media properties, air space, water-holding capacity, phytotoxins, pH.

Introduction

Forest and conservation nurseries have used container-grown plants for decades to produce diverse crops for specific purposes. While there are advantages and disadvantages to growing plants in containers, many out-planting markets prefer container-grown plants. But growing plants in containers is not as simple as it may sound. Growers can manipulate the growing environment by using greenhouses, mechanizing production practices, changing the size of the container, and selecting different media for the roots to grow in.

Container media continues to evolve as the use of new or different materials (components) are investigated. A couple of reasons for change might be the cost and availability of the currently used components. Additional reasons might be if the current component is considered a health risk, or if harvest of the component is not viewed as an environmentally sound practice, or it no longer fits with changes made to the nursery production system.

This paper will address some of my thoughts that a nursery manager should consider when deciding whether or not to change their container media. These thoughts are partially based on studies conducted at the Oregon State University North Willamette Research and Extension Center located near Aurora, Oregon. Container media studies have been conducted there for over 40 years collectively by Dr. Robert Ticknor (deceased), Dr. David Adams (retired), Dr. James Altland (USDA-ARS, Wooster, Ohio), Dr. Jim Owen (Virginia Tech, Virginia Beach, Virginia) and myself.

Organic and Inorganic Components of Growing Media

Container media provides a crucial balance of air, water, pH and soluble salts that is impossible to obtain using a mineral soil. Therefore, to successfully grow plants in a container a soilless media is used instead of soil. Soilless growing media are composed of organic and inorganic components that are regionally supplied.

The primary organic component used by the landscape plant industry in the Pacific Northwest is both aged and fresh Douglas-fir bark (50% to 100% of the growing media by volume). Sphagnum peat moss is usually the major organic component for small containers and plug type trays. The Cornell Peat-lite mixes are a good example of a media used for floriculture and forest tree seedling crops. Other organic media components used in this region include coir (coconut husk), rice hulls, and various composts.

The inorganic component that is used extensively in the Pacific Northwest, especially for larger sized containers, is pumice (volcanic rock). Perlite and vermiculite are two inorganic materials that are components of the Peat-lite mixes. Sometimes other inorganic materials are added to the container media for a specific purpose. For example, Zeolite is used to help absorb excess amounts of ammonia fertilizer; or sand is used to increase container weight to help avoid tall plants from tipping over; or pelletized clay can be used to increase the cation exchange capacity (CEC) of the media to help retain certain nutrients and avoid losses due to leeching.

Matching Media with the Nursery System

Fit with Container Types Used

A container nursery develops a system of growing plants that is unique to their operation. Plants are grown in various sizes of containers ranging from narrow and long tubes for young seedlings to short and wide containers used to grow eight-foot tall trees. Some growers use plug trays or containers designed to encourage good root development by air pruning roots. The Peat-lite mixes are very useful in plug trays due to the relatively small size of perlite, vermiculite and sphagnum peat moss grades that are available. Some grades of coir may not be suitable for this use due to their long, stinky fibers.

The value of an alternative media component is directly related to its ability to be used in more than one type of container. Different media components may not work as well depending on the type and size of container. For example, while coarse Douglas-fir bark (3/8 – 1 inch) particles work well in containers greater than six inches, they will not even fit into a plug tray. On the other hand, Douglas-fir bark can be hammered, ground and screened to a smaller size that will fit into a plug tray.

Fit with the Nursery Production System

It is not just how the media fits in the container, but also how the media is handled within the nursery system. How well the media flows through filling machines or if the alternative material requires special handling, such as breaking up Coir bricks before it is mixed with the other components. Another consideration is whether or not a nursery mixes their own media on site or if they purchase media from a supplier. If the latter, then the value of an alternate material is also dependent on the ability and willingness of a supplier to work with this material. Some practices observed at different nursery operations can lead to increased compaction of the media and should be accounted for when changing media components.

Ability to Anchor Root Systems

Since the roots anchor a plant, the media must allow roots to explore the entire container space and be stable enough to prevent shifting. If the plant wobbles in the pot then either the media is not stable and/or the roots are having a difficult time growing. After Douglas-fir bark is ground, the pieces tend to lock together and provide good anchorage for the roots. In this way, Douglas-fir bark is very similar to other tree barks used for container media. Sphagnum peat moss also has this ability to help bind and stabilize a media. This binding of the media particles depends upon their shape. A round, smooth particle tends to shift around more. The shape of tree bark particles used for media are angular and irregular. Along with particle shape, the size of the solid particles will determine the porosity of the media.

Properties of Container Media

Organic and inorganic components are mixed at various ratios to create container media with unique physical and chemical properties. Total porosity (TP) is the percent by volume of empty space in the container media that is created by the arrangement of solid particles. This empty space will be filled with either air or water depending on the size of the pores created. The large pores (macro-pores) provide air to the plant roots, while the small pores (micro-pores) hold most of the water needed by the plant. Air space (AS) and water holding capacity (WHC) are terms used to characterize a container media. Good root and shoot growth depends on the relative amount of water and air that a media will hold.

Both the physical and chemical properties of any organic component based container media are dynamic in nature. Organic matter decomposes rapidly in a container as the requirements for microbial activity is usually ideal. Warm temperature, high air exchanges, plenty of moisture, and proper levels of nutrients allow these decomposers to chew through organic matter in a short amount of time. This is one of the reasons that fresh straw stubble (grass seed or wheat) has not worked well as a container media.

As the media organic matter decomposes, the particle size decreases, which increases WHC and decreases AS. In addition, the decomposition process alters the pH of media and can release certain compounds that could affect plant growth. I once observed abnormal growth of plants grown in a media that used mint compost as a component. The release of the herbicide (clopyralid) used in mint production was the suspected causal agent of this disorder. For these reasons, media components should have a level of stability that resists decomposition.

Douglas-fir bark and sphagnum peat moss have general properties or characteristics that make them a superb component of container media. Both these components resist decomposition, are generally uniform, and have been available and cost effective. But for various reasons, growers are always looking for alternatives for these organic materials. Most often these alternative components are waste or by-products from another activity, such as composting. These materials must be able to show stable and reproducible physical and chemical properties season after season. The source of the material should be consistent and abundant enough to continue a steady supply.

Physical Properties

Guidelines for the physical properties of container media will vary greatly depending on the nursery system and growing region. For instance, the general range for container media AS is 10% to 30% but that does not mean that the best AS is 20%. Plants with high transpiration rates grown in tall containers will do well with an AS of 10%. Likewise, plants grown in plug trays prefer an AS of 7% to 10%, as they need the media to hold as much water as possible due to the limited amount of media in each cell. A plant grown outdoors in a larger container (>3.0 liters) in western Oregon would likely prefer an AS of 20% to 30% due to abundant winter and spring rains. In addition, some plant pathogens, such as *Phytophthora* and *Pythium*, are more problematic with a lower AS, compared to a media with 25% to 30% AS.

Growing plants in high AS media increases irrigation frequency during the summer months and will generally lower the WHC. The addition of 30% sphagnum peat moss (by volume) to a Douglas-fir base media can drop AS from 30% to 20% and increase WHC from 50% to 70%. The recommended range for WHC is 45% to 65%. But not all of this water is available to the plant. Usually, only about half of the WHC is readily available as the rest is held tightly by the media particles and micro-pores.

An important point to consider is how the alternative material you are considering would be used. Will it be a major component of the media or serve as the base component? Or, will it be used as a minor component to enhance or improve another base material? The physical properties of a single media component is not as important as how it interacts with the other components. The overall physical properties of the media mix (blend) are what count. Of course, if the alternative component is going to be the base for the media (>60%), then determining its specific physical properties will be useful.

There are few labs across the country that will determine the physical properties of container media. Their results are accurate but not necessarily standardized between them all. However, determining the AS and WHC of a media can be done at the nursery or greenhouse using a simple method. First determine the volume of media the container will hold by taping off the drainage holes and filling it with water to the level the media would reach. Measure the amount of water and this is the TP. Then fill the container with media and pack slightly by tapping it on a top of a table. Slowly pour water into the container filled with media until the water level is even with the media and air no longer bubbles out. Pull the tape and allow the saturated media to drain. Collect and measure the volume of the drainage water (leachate) in milliliters (ml). This value is the AS and represents the amount of macro-pores in the media. You can calculate the percentage of air space by dividing this value by the TP and multiplying by 100. To determine the WHC, weigh the wet media in grams (g) minus the weight of the container. Then spread the media in a metal pan and allow it to dry completely in a warm greenhouse or room. Weigh it again after it is dry. The difference between the wet weight and the dry weight is the total WHC. Using the simple conversion that 1.0 g of water is about equal to 1.0 ml, you can calculate the percent WHC by dividing it by the TP and multiply by 100.

Determining these basic physical properties of media will provide you with information to make sound decisions when considering an alternative media component. You can measure the AS and WHC of your current media and either make changes to them or try to keep them the same, especially if your plants grow well in it.

A common thought was that adding sand to a media would improve drainage and AS. But this is not the case, as the sand is a small particle size and it decreases AS and increases WHC by adding more micro-pores. Also, it was thought that adding pumice to a Douglas-fir base media would increase AS. This was not the case — adding up to 30% pumice did not change the AS of the media but WHC was reduced. Pumice does appear to help stabilize the physical properties due to the fact that it will not decompose like organic matter does.

Chemical Properties

The most important chemical property of a container media is that it must be free of any substances that are toxic to plant growth. This will include the total soluble salts, specific ions and certain compounds. I have observed numerous plant growth disorders (even plant death) as a result of using composts, improperly stored organic matter, sewage sludge, and inorganic materials.

Any alternative media component being considered for use must be tested for chemical properties using an appropriate analytical lab. This is different than what I suggested for testing the physical properties. While a grower can do a preliminary test for pH and electrical conductivity (EC) for total soluble salts using the PourThru technique (as described in Whipker and others 2001), a more complete analysis is required to determine if certain ions are present at unacceptable levels. Unfortunately, it would be far too costly to test for every possible plant toxin known. For example, you could test for certain heavy metals that

are often found in sewage sludge, but it would likely be impractical to test and detect any herbicide residue in composted materials.

If your alternative material passes the chemical analysis, it can be blended with the other media components to obtain the desired physical properties. At that point, re-test the chemical properties of the completed media blend. Test the new media using the PourThru method and a commercial lab. Compare your results to standard guidelines developed for container media. These can be found by searching the Internet or in the reference books listed at the end of this article.

Avoid using any media with an EC reading above the recommended range. EC levels of media components should be less than 0.75 dS/m or 500 ppm using the PourThru method. Plants affected by salinity are stunted and grow more slowly. If it is above, further evaluation is necessary to determine the source of the soluble salts. Sometimes the media can be leached to remove the salts but it may require leaching the media more than once as it is difficult to leach salts from organic matter. In addition, leaching is a process that must be done routinely and the media monitored frequently. It is possible that the specific ions causing the high EC readings are toxic to plants in high levels.

The pH of the media is something that can be adjusted using pre-plant amendments and fertilizer applications during the growing season. In general, a pH range from 5.5 to 6.3 works well for container media. The alkalinity of irrigation water has a great affect on the pH of the media and must be managed to order to stay within the required range. As mentioned earlier, the pH of fresh organic matter changes dramatically during the decomposition process. At first the pH stays about the same or drops slightly before it rapidly increases. Then it will slowly decline often to a level lower than it was initially. Aged Douglas-fir bark just starting the decomposition process is often lower in pH (4.0) compared to fresh Douglas-fir bark (4.5). After a few months, Douglas-fir bark can have a pH close to 5.5 before dropping to 4.0 in about six months. Understanding this pH change that occurs in all decomposing organic matter helps to more accurately monitor and manage container media pH.

The microbes decomposing the organic matter in a container require a significant amount of nitrogen. Unfortunately for the plants, the microbes are more efficient at obtaining the available nitrogen and can out-compete the plant roots. This phenomenon is known as “nitrogen drawdown” and must be accounted for when making changes to the media involving organic matter. A lab can estimate the amount of nitrogen used by the microbes for any given media and is called the “Nitrogen Drawdown Index.” For most bark-based media mixes, it takes about 0.75 lbs of actual nitrogen per cubic yard of media (.44 kg per cubic meter) the first growing season to compensate for the nitrogen used by the microbes. Peat moss, and most well composted materials, generally have a lower nitrogen requirement. Some alternative materials being studied includes cull trees (such as Christmas trees, nursery shrubs and trees, etc.) or timber harvest slash that is hammered and ground to a specific size. The wood component of such a material will usually have a higher nitrogen drawdown compared to Douglas-fir bark or peat moss.

Phytotoxins are natural chemicals in barks, sawdust, or other organic materials that are toxic to plants. One concern is that large heaps of organic matter (such as bark or sawdust) composting under anaerobic conditions cause “charring” creating toxins. This condition can be recognized by the sour smell and very low pH <3.0 of the material. Phytotoxins are not readily removed by leaching. Proper composting usually helps degrade these toxins but it would be best not to use this alternative media source at all.

Conducting a live plant study (bioassay) on an alternative material is always a good practice. A quick and easy test is to germinate and grow lettuce in the new components under greenhouse conditions. If

the component passes this test and the lettuce grows with no visible growth disorders, then blend the component with other media components and test again with the lettuce seed. If things still look good, then conduct a longer-term study for at least one crop rotation using several of the plants grown at the nursery.

Summary

The objectives of any container media are to provide anchorage for the plant, allow oxygen and gas exchange for roots, retain nutrients for root uptake, and provide a reservoir for water. In addition, the media components made up of either organic or inorganic materials must be non-toxic to plants, be available and cost effective, and match the nursery production system. There are multiple characteristics to consider as alternative materials are evaluated to improve container media. On-site testing and lab analysis are tools a nursery manager can use to determine the physical and chemical properties of any given combination of media components. In addition to these tests, it would be wise to evaluate crop growth and development on a trial basis before switching over to a new media on a widespread scale.

References

- Dumroese, RK, Luna T, Landis, TD. editors. 2009. Nursery manual for native plants: A guide for tribal nurseries - Volume 1: Nursery management. Agriculture Handbook 730. Washington, DC: USDA-FS. 302p.
- Handreck K, Black N. 2010. Growing media for ornamental plants and turf. 4th Edition. UNSW Press, Sydney, Australia. 551p.
- Landis TD, Tinus RW, McDonald SF, Barnett JP. 1990. Containers and growing media, Vol. 2. The Container Tree Nursery Manual. Agric. Handbook 674. Washington, DC, USDA-FS. 88p.
- Whipker BE, Cavins TJ, Fonteno WC. 2001. 1, 2, 3's of PourThru. North Carolina State University Floriculture Research. URL: <http://www.ces.ncsu.edu/depts/hort/floriculture/Florex/PourThru%20Handout%20123s.pdf> (accessed 10 Feb 2014).

Benefits of Small-Prill Controlled-Release Fertilizer in Container Production

Nabil Khadduri

Nabil Khadduri, Nursery Scientist, Webster Forest Nursery, Washington Department of Natural Resources, PO Box 47014, Olympia, WA 98504; E-mail: nabil.khadduri@dnr.wa.gov.

Khadduri N. 2014. Benefits of Small-Prill Controlled-Release Fertilizer in Container Production. In: Wilkinson KM, Haase DL, Pinto JR, technical coordinators. National Proceedings: Forest and Conservation Nursery Associations—2013. Fort Collins (CO): USDA Forest Service, Rocky Mountain Research Station. Proceedings RMRS-P-72. 54-56. Available at: http://www.fs.fed.us/rm/pubs/rmrs_p072.html

Abstract: Microprill fertilizer granules (<1.0 mm width) were incorporated into soilless media at a 2 lb/yd³ (1.2 k/m³) rate and compared with an operational standard of 6 lb/yd³ (3.6 k/m³) incorporation of a standard-size prill (>2.4 mm/0.09 in width). Micro prill counts per cell averaged 5.0, 7.8 and 9.4 times higher than standard-sized prill counts for 2, 10 and 15 cu in (207A, 415D and 515A) Stuewe styroblock containers (Stuewe & Sons, Inc 2014), respectively. Coefficients of variation of micro prills per cell were 3 times lower across container sizes compared with standard-sized prills per cell. These results demonstrate the potential for micro prills to improve crop uniformity through decreased fertilizer variability. A separate study evaluated the effectiveness of iron sulfate prills in inhibiting moss and liverwort establishment on a bark and peat-based medium. Standard-sized prills of 90- and 180-day release patterns were top dressed at rates of 25 lb and 50 lb per 1,000 ft² (122 and 244 kg per 1,000 m²) along with an untreated control. After 12 weeks, the 50 lb (244 kg) rate of 180-day release had the lowest moss coverage at 24% compared to 57% coverage for the untreated control. A second trial compared 75 lb per 1,000 ft² (366 kg per 1,000 m²) top-dressing of three iron sulfate controlled release fertilizer products (standard size prills of 90- and 180-day release patterns and a mini-sized prill of 90-day release pattern) and an untreated control. After 12 weeks, the combined moss and liverwort coverage was 78% for the untreated control, while the mini-size prill treatment was significantly lowest at 7% coverage. These trials demonstrate that controlled-release iron sulfate can prevent moss and liverwort establishment when applied at an adequate rate using a mini-sized product that allows for even product distribution.

Key Words: container fertilization, iron sulfate, moss, liverwort

Introduction

Most container seedling growers now incorporate controlled-release fertilizer into their soil media in order to provide a consistent background level of nutrition. This is especially important during cool, wet periods, when irrigation, and therefore water-soluble fertilizer, is withheld. Longer controlled-release formulations allow for continued nutrient availability from the fertilizer prills even after the plug has been outplanted (Jacobs and others 2003). Other benefits of controlled-release fertilizer incorporation include improved fertilizer-use efficiency and the associated environmental benefits of targeted nutrient application, labor savings from minimizing batching and application involved in fertigation, and reduced pest buildup associated with surface nutrient application.

Despite these benefits, some growers complain about losing control when applying controlled-release fertilizers (Landis and others 1989). Even with advances in fertilizer durations and release patterns, growers reduce the ability to manipulate key leverage points such as using a specific period of nutrient starvation to help initiate the hardening process. In addition, whereas water soluble fertilizer feeds provide readily available

nutrients in a desired balance, controlled-release fertilizers tend to release nutrients more variably (Haase and others 2007). For example, from the same prill, nitrogen tends to release faster than potassium, which in turn releases faster than phosphorus (Jacobs 2005). Finally, poor prill distribution in the soil media can increase crop variability. This problem is accentuated in small containers. One way to improve prill distribution is to incorporate micro (i.e. small-sized) prills.

Nomenclature for Prill Sizes

It is useful to understand some nomenclature about prill sizes as described on fertilizer products. Size guide number (SGN) is a measure of the prill width in millimeters x 100. So, a fertilizer with a SGN of 180 contains granules with an average diameter of 1.80 mm (Samples and others 2011).

The terms that generally correlate with prill sizes are described in table 1.

In the following studies smaller-sized prills were compared against standard-sized prills with the goal of increasing prill distribution and therefore crop performance.

Table 1: Terms Describing Prill Sizes

Prill Description	SGN (Size Guide Number)	Average Size (mm)
Standard/Regular	>240	>2.40
Midi/Midgrade	195 to 220	1.95 to 2.20
Mini	145	1.45
Nano	100 to 150	1.00 to 1.50
Micro	<100	<1.00

Study #1: Does Incorporating Smaller Prills into Media Improve Prill Distribution?

Materials and Methods

The first study was conducted at Webster Nursery (WA State Department of Natural Resources) in Olympia, Washington. Standard-size prills (greater than or equal to 2.4 mm width) of controlled release fertilizer were incorporated into a 80% peat/20% perlite soilless media at an operational standard rate of 6 pounds per cubic yard. For comparison, micro-sized prills (less than or equal to 1mm width) were incorporated into soilless media at a rate of 2 lb/yd³ (1.2 k/m³). Prill counts were taken of media samples (whole containers) before and after operational filling into 2, 10, and 15 cu in styrobloc containers (207A, 415D and 515A) Stuewe styrobloc containers (Beaver Plastics). Twenty containers per treatment/container size combination were evaluated.

Results and Discussion

No significant differences in prill counts between pre- and post-container filling were found, indicating nursery operational practices did not confound prill counts. Even at the 1/3 rate of micro prill incorporation, micro prill counts per cell averaged 5.0, 7.8 and 9.4 times higher than standard-sized prill counts for the 2, 10 and 15 cu in (207A, 415D and 515A) containers, respectively (figure 1). Coefficients of variation of micro prills per cell were 3 times lower across container sizes than standard-sized prills per cell (figure 2).

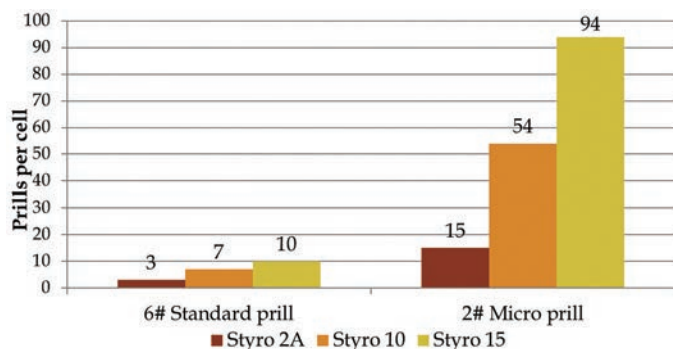

Figure 1. Micro prill counts per cell averaged 5.0, 7.8 and 9.4 times higher than standard-sized prill counts for the 2, 10 and 15 cu in (207A, 415D and 515A Stuewe styrobloc) containers, respectively.

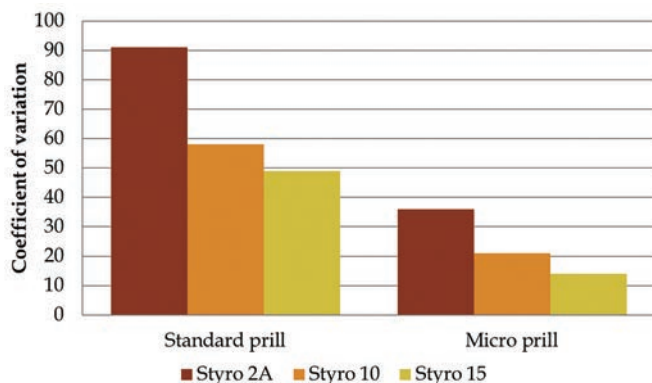

Figure 2. Coefficients of variation of micro prills per cell were 3 times lower across container sizes than standard-sized prills per cell.

Summary

Three times better distribution at 1/3 rate of incorporation demonstrates the potential for micro prills to improve crop uniformity through decreased fertilizer variability.

Study #2, Trial #1: Can Top-dressing with Iron Sulfate Prills Control Moss and Liverwort?

Materials and Methods

At the Meridian Seed Orchard greenhouse (Washington Department of Natural Resources) near Lacey, WA, a separate study was conducted to evaluate the effectiveness of top-dressed controlled release iron sulfate prills in inhibiting moss and liverwort establishment on a bark and peat-based medium growing 2-year-old Douglas-fir grafted seedlings. In the first trial, rates of 25 lb and 50 lb per 1,000 ft² (122 and 244 k per 1,000 m²) were top-dressed with standard-sized prills of 90- and 180-day release patterns respectively, along with an

untreated control. Materials were applied to styro 60 cu in (1015A) containers (Beaver Plastics), covering a surface area of 12.56 in² (81 cm²) per container. Twenty-one containers per application rate/release pattern combination were evaluated for percentage moss and liverwort surface coverage at 6 and 12 weeks after treatment. Seedlings were inspected for signs of phytotoxicity at week 12.

Results and Discussion

Six weeks after treatment, moss coverage (no liverwort present) was 39% for the untreated control, 21% and 19% for the 25 lb (122 kg) rate of 90- and 180-day release, and 12% and 11% for the 50 lb (244 kg) rate of 90- and 180-day release. After 12 weeks, the 50 lb (244 kg) rate of 180-day release had the lowest moss coverage at 24% compared to 57% coverage for the untreated control (figure 3). No phytotoxicity was observed 12 weeks following application.

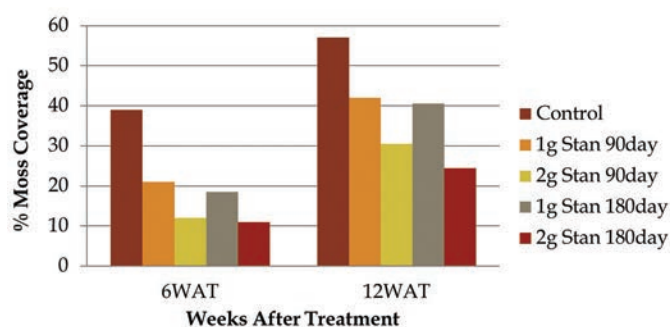

Figure 3. Moss coverage 6 and 12 weeks after treatment. After 12 weeks, the 50 lb rate of 180-day release had the lowest moss coverage at 24% compared to 57% coverage for the untreated control.

Study #2, Trial #2: Can Top-Dressing With Small-Size Iron Sulfate Prills Improve Moss and Liverwort Control?

Materials and Methods

A second trial compared a higher rate of 75 lb per 1,000 ft² (366 kg per 1,000 m²) top-dressing of three iron sulfate controlled release fertilizer products; standard size prills of 90- and 180-day release patterns, a mini-sized prill (1.45mm average size) of 90-day release pattern and an untreated control. Twenty-one containers per application rate/release pattern combination were evaluated for percentage moss and liverwort surface coverage at 6 and 12 weeks after treatment. 2-year-old Douglas-fir grafted seedlings were inspected for signs of phytotoxicity at week 12.

Results and Discussion

Six weeks after treatment, combined moss and liverwort coverage for the untreated control was 45%, standard-size prills of 90- and 180-day release both showed 10% coverage, while the mini-sized prill was significantly lowest at 5% coverage. After 12 weeks, the combined moss and liverwort coverage rose to 78% for the untreated control, while the mini-size prill remained significantly lowest at 7% coverage (figure 4). No phytotoxicity was observed 12 weeks following application.

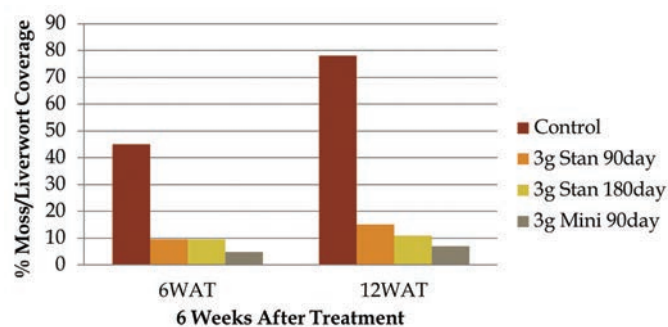

Figure 4. Combined moss and liverwort coverage 6 and 12 weeks after treatment. After 12 weeks, the combined moss and liverwort coverage rose to 78% for the untreated control, while the mini-size prill remained significantly lowest at 7% coverage.

These trials suggest the best way to use controlled-release iron sulfate to prevent moss and liverwort establishment is to get good coverage, achieved by applying both an adequate rate as well as a mini-sized product that allows for even product distribution. Note that the product was applied to Douglas-fir, an iron-loving species.

Summary Study #2, Trials 1 and 2

Whether incorporating into media or top-dressing, smaller-size prills offer the promise of improved fertilizer distribution, ultimately providing the grower another tool to improve crop uniformity.

References

- Haase DL, Alzugaray PO, Rose R, and Jacobs DF. 2007. Nutrient release patterns of controlled-release fertilizers in forest soil. *Communications in Soil Science and Plant Analysis* 38:739-750.
- Jacobs DF, Rose R, Haase DL. 2003. Incorporating controlled-release fertilizer technology into outplanting. In: Riley LE, Dumroese RK, Landis TD, technical coordinators. *National Proceedings: Forest and Conservation Nursery Associations—2002*. Ogden, UT: USDA Forest Service, Rocky Mountain Research Station. Proceedings RMRS-P-28: 37–42.
- Jacobs DF. 2005. Variation in Nutrient Release of Polymer Coated Fertilizers. In: Dumroese, R. K.; Riley, L. E.; Landis, T. D., tech. coords. *National proceedings: Forest and Conservation Nursery Associations—2004*; 2004 July 12–15; Charleston, NC; and 2004 July 26–29; Medford, OR. Proc. RMRS-P-35. Fort Collins, CO: U.S. Department of Agriculture, Forest Service, Rocky Mountain Research Station.
- Landis TD, Tinus RW, McDonald SE, Barnett JP. 1989. Seedling Nutrition and Irrigation, Vol. 4, *The Container Tree Nursery Manual*. Agric. Handbk. 674. Washington, DC: U.S. Department of Agriculture, Forest Service. 119 p.
- Samples T, Sorochnan J, Thomas A. 2011. Are you getting the most from your granular nitrogen fertilizers? *Sports Turf Online*. URL: <http://sturf.lib.msu.edu/article/2011jul8b.pdf> (accessed 31 July 2013).
- Stuewe & Sons, Inc. 2014. Beaver Styroblocks. <http://www.stuewe.com/products/datasheets/beaver.pdf> (accessed 10 Feb 2014).

New and Emerging Herbicide Tools for Weed Control in Conifer Nurseries

Tim Miller and Ed Peachey

Tim Miller, Extension Weed Scientist, Washington State University Northwestern Washington Research and Extension Center, 16650 State Route 536, Mount Vernon, WA 98273; E-mail: twmiller@wsu.edu

Ed Peachey, Weed Scientist, Oregon State University, 4017 Ag and Life Sciences Building, Corvallis, OR 97331-7304; E-mail: peacheye@hort.oregonstate.edu

Miller T, Peachey E. 2014. New and Emerging Herbicide Tools for Weed Control in Conifer Nurseries. In: Wilkinson KM, Haase DL, Pinto JR, technical coordinators. National Proceedings: Forest and Conservation Nursery Associations—2013. Fort Collins (CO): USDA Forest Service, Rocky Mountain Research Station. Proceedings RMRS-P-72. 57-61. Available at: http://www.fs.fed.us/rm/pubs/rmrs_p072.html

Abstract: Testing of new herbicides, alone or in combination with currently registered herbicides, is necessary to control weed species without causing damage to tender tree seedlings. In this study, several herbicides were tested for selectivity on seedling conifers during 2011. Trials were conducted at two sites operated by the Weyerhaeuser Company, one at the Aurora Forest Nursery near Aurora, Oregon, and the second at the Mima Forest Nursery, near Olympia, WA. Weed control at Mima exceeded 85% most of the season. At Aurora, all preemergence (PRE) treatments initially provided excellent control, although control with indaziflam had decreased to 71% by August. At Mima, Douglas-fir seedlings were injured by PRE applications of flumioxazin and flumioxazin + pyroxasulfone, and by postemergence (POST) applications of imazamox and fluroxypyr. At Aurora, Douglas-fir seedlings were injured most by fluroxypyr, imazamox and saflufenacil. Western hemlock seedling shoot weight was reduced by indaziflam and fluroxypyr, while imazamox and the split-applications of mesotrione also decreased hemlock shoot height at harvest.

Key Words: Douglas-fir, western hemlock, *Pseudotsuga menziesii*, *Tsuga heterophylla*, pest management

Introduction

Bareroot forest tree nurseries grow trees from seed, rooted cuttings, or from smaller trees transplanted into the nursery. Field nurseries produce tree seedlings that are used to regenerate lands that have been harvested, or destroyed by disease or fire. These nurseries also grow seedlings for the Christmas tree industry, or for ornamental and pharmaceutical markets.

Pest management is a significant nursery challenge. Weeds represent the second most problematic pest in bareroot Pacific Northwest nurseries, with the biggest problem being disease from soil-borne, stem, and foliar pathogens (Masters 2009). A typical tree marketed from bareroot nurseries in the Pacific Northwest is a two-year-old tree (Weiland and others 2011). Reduced growth due to weed competition results in a tree seedling of lower vigor and quality, and may result in an inability to meet customer expectations and a loss of business in future years. In addition, tree seedlings contaminated with certain weed species (such as yellow nutsedge, *Cyperus esculentus*) may result in a quarantine that prevents certain lots from being sold at all (WSDA 2013). To put this into perspective, in 2003, Washington State planted nearly 111,000 acres, and its nurseries shipped 118 million trees at an estimated value of \$11.2 million. Production is similar for Oregon (Weiland and others 2011). Trees of poor vigor or those contaminated with weed propagules can sometimes be replaced, but usually won't be replaced with those of the same genetic potential. The value of genetically improved trees is reflected in an average net present value contribution of \$50 per acre over trees planted with unimproved seedlings, which could yield as much as \$5.0 million net present value (NPV) annually based on current production (Masters 2009).

While fumigation is helpful, it generally provides only partial weed control and is usually augmented with herbicides followed by periodic hand weeding. Registered herbicides either do not provide adequate control of many weed species, or do not persist long enough to control later-germinating weeds. Testing of new herbicides, alone or in combination with currently registered herbicides, is necessary to fully control these species without causing damage to tender tree seedlings.

Materials and Methods

Trials were conducted at two sites operated by the Weyerhaeuser Company, one at the Mima Forest Nursery, near Olympia, Washington and the second at the Aurora Forest Nursery near Aurora, Oregon. Douglas-fir (*Pseudotsuga menziesii*) seedlings were included at both sites, while western hemlock (*Tsuga heterophylla*) seedlings were included at Aurora. Seedlings were transplanted in late May and soil was allowed to firm from rainfall as tree seedlings hardened for at least three days. Plots (8 by 8 ft [2.4 by 2.4 m]) were established prior to budbreak and preemergence (PRE) herbicides were applied May 23 at Aurora and June 1 at Mima. CO₂-pressurized backpack sprayers were used for both applications. Following budbreak, postemergence (POST) herbicides were applied June 28 at Mima and July 29 at Aurora. Application information is included in table 1. Weed control and crop injury were visually estimated June 28 and August 9 at Mima, and height of three randomly selected trees in each treatment was measured August 9. At Aurora, weed control and crop injury were evaluated June 16 and July 29, and weed control August 11. The height of ten consecutive trees from the center of each plot was measured July 29. Ten adjacent trees from randomly selected locations in each plot were harvested on October 17 at Aurora and December 6 at Mima, and shoot and root weight, shoot length, stem caliper, and general observations on seedling defects (chlorosis, stem straightness, and so on) were recorded. Data were analyzed using SAS, and means were separated using Fisher's Protected Least Significant Difference (LSD) (P = 0.05).

Results

Weed Control

At Mima, weed control exceeded 90% for all treatments (table 2). Non-treated plots and plots just prior to hand weeding, estimated at 84 to 88% control (16 and 12% weed cover). Primary weeds at Mima were annual bluegrass (*Poa annua*), black cottonwood (*Populus balsamifera* ssp. *trichocarpa*), common groundsel (*Senecio vulgaris*), and dandelion (*Taraxacum officinale*).

At Aurora, all PRE treatments were providing excellent control, although control with indaziflam had decreased to 71% by August. POST treatments were uniformly poor, perhaps due to the lateness of the application in relation to date of evaluation. Primary weeds at Aurora were common groundsel (*Senecio vulgaris*), horseweed (*Conyza canadensis*), witchgrass (*Panicum capillare*), and smooth crabgrass (*Digitaria ischaemum*).

Tree Seedlings

At Mima, Douglas-fir seedlings were injured by PRE applications of flumioxazin and flumioxazin + pyroxasulfone, and by POST applications of imazamox and fluroxypyr (table 2). Damage from the PRE applications were needle necrosis and loss, as well as tip die-back and stunting. Damage from the imazamox application was chlorosis of new needle growth. Damage from the fluroxypyr application was needle

Table 1. Herbicide Application information Mima and Aurora forest nurseries (2011).

Timing	Date	Temperature	Wind	Sun	New growth	Moisture
Aurora						
PRE	May 23	55 °F (12.8 °C)	W 0-2 mph (0-3.2 kph)	Clear	Dormant	Damp
POST	July 29	66°F (18.9 °C)	W 0-1 mph (0-1.6 kph)	50% cloud cover	2-6 in (5-15 cm)	Damp
Mima						
PRE	June 1	53 °F (11.7 °C)	Light and variable	Overcast	Dormant	Soil damp, trees dry
POST	June 28	60 °F (15.6 °C)	SW 7-10 mph (11.3-16.1 kph)	Overcast	1-2 in (2.5-5 cm)	Soil dry, trees dry

Table 2. Mid-season weed control and foliar injury to Douglas-fir seedlings at Mima Forest Nursery after treatment with various early-season herbicides (2011).

Treatment ^z	Rate (product/a)	Rate (lb ai/a)	Timing	Weed control ^y (%)	Foliar injury ^y (%)	Height ^x (cm)
Indaziflam	5 fl.oz	0.065	PRE	100 a	0 d	30.5 a
Mesotrione	6 fl.oz	0.188	PRE	100 a	0 d	30.3 a
Dithiopyr	12 fl.oz	0.188	PRE	95 bc	0 d	29.6 ab
Flazasulfuron	2 oz	0.031	PRE	100 a	0 d	27.2 bc
Pendimethalin + dimethenamid-p	200 lb (granule)	3.5 (total)	PRE	99 ab	1 d	30.2 a
Isoxaben	11 oz	0.516	PRE	98 abc	0 d	32.2 a
Oxyfluorfen	1 pt	0.5	PRE	99 ab	0 d	31.0 a
Dithiopyr	7.6 oz	0.19	PRE	96 abc	0 d	32.5 a
Trifluralin + isoxaben	100 lb (granule)	2.5 (total)	PRE	99 ab	0 d	30.1 ab
Flumioxazin	8 oz	0.25	PRE	100 a	28 b	23.7 d
Flumioxazin + pyroxasulfone	8 oz	0.38 (total)	PRE	100 a	29 b	23.8 d
Imazamox	5 fl.oz	0.039	POST	99 ab	6 c	30.5 a
Fluroxypyr	10.7 fl.oz	0.125	POST	94 c	48 a	24.8 cd
Nontreated	---	---	---	88 d	0 d	31.1 a
Hand-weeded	---	---	---	84 d	0 d	30.8 a

Means within a column followed by the same letter or not followed by a letter are not significantly different (LSD0.05).

^z Treatments were applied June 1 preemergence (PRE) and June 28 postemergence (POST).

^y Weed control and foliar injury was estimated August 9.

^x Height of three trees was measured August 9.

necrosis and twisting of the stem and new growth. Height of Douglas-fir trees treated with flumioxazin and flumioxazin + pyroxasulfone, and fluroxypyr was significantly reduced, while trees treated with imazamox generally were symptom-free and of similar height as non-treated trees. At harvest, trees treated with flumioxazin, fluroxypyr, and to a lesser extent, flumioxazin + pyroxasulfone, displayed reduced shoot fresh weight and caliper (table 3). Fluroxypyr treatment reduced stem length by harvest, while trees treated with flumioxazin were shorter than those treated with other herbicides, but similar to the height on non-treated trees.

At Aurora, mid-season evaluations indicated that Douglas-fir seedlings were most sensitive to saflufenacil while western hemlock

appeared to be tolerant (table 4). Flumioxazin also reduced the growth of hemlock but not Douglas-fir seedlings. Mesotrione applied twice at 12 oz/acre caused significant foliar injury and reduced hemlock seedling height, while Douglas-fir seedlings were unaffected. At harvest, Douglas-fir seedlings were impacted most by fluroxypyr, imazamox and saflufenacil (table 5). Western hemlock seedling shoot weight was reduced by indaziflam and fluroxypyr, while imazamox and the split-applications of mesotrione also decreased hemlock shoot height at harvest (table 6). Western hemlock was unaffected by saflufenacil. Neither root weight nor stem caliper of western hemlock were significantly affected by herbicide application.

Table 3. Effect of early-season herbicides at harvest of Douglas-fir at Mima Forest Nursery (2011).

Treatment ^z	Rate (product/a)	Rate (lb ai/a)	Timing	Shoot ^y (g)	Root (g)	Height (cm)	Caliper (mm)
Indaziflam	5 fl.oz	0.065	PRE	316 a	75	42.5 ab	7.3 a
Mesotrione	6 fl.oz	0.188	PRE	303 ab	69	39.7 abc	7.0 abc
Dithiopyr	12 fl.oz	0.188	PRE	288 ab	68	40.5 abc	6.7 abc
Flazasulfuron	2 oz	0.031	PRE	322 a	85	42.7 ab	7.1 abc
Pendimethalin + dimethenamid-p	200 lb (granule)	3.5 (total)	PRE	270 abc	60	40.2 abc	6.9 abc
Isoxaben	11 oz	0.516	PRE	297 ab	63	42.7 ab	7.0 abc
Oxyfluorfen	1 pt	0.5	PRE	297 ab	74	43.3 a	7.2 ab
Dithiopyr	7.6 oz	0.19	PRE	289 ab	67	43.7 a	7.1 abc
Trifluralin + isoxaben	100 lb (granule)	2.5 (total)	PRE	302 ab	72	41.9 ab	7.0 abc
Flumioxazin	8 oz	0.25	PRE	205 cd	63	33.0 d	6.3 c
Flumioxazin + pyroxasulfone	8 oz	0.38 (total)	PRE	227 bc	68	35.2 cd	6.6 abc
Imazamox	5 fl.oz	0.039	POST	286 ab	66	37.5 bcd	6.6 abc
Fluroxypyr	10.7 fl.oz	0.125	POST	132 d	34	33.2 d	5.5 d
Nontreated	—	—	—	295 ab	70	41.8 ab	6.5 bc
Hand-weeded	—	—	—	267 abc	67	41.0 ab	6.4 bc

Means within a column followed by the same letter or not followed by a letter are not significantly different (LSD0.05).

^zTreatments were applied June 1 preemergence (PRE) and June 28 postemergence (POST).

^yShoot and root weight, shoot height, and stem caliper were measured December 6.

Table 4. Mid-season weed control and foliar injury to Douglas-fir and western hemlock seedlings at Aurora Forest Nursery after early-season treatment with various herbicides (2011).

Treatment ^z	Rate (product/a)	Rate (lb ai/a)	Timing	Weed control ^y (%)	Douglas-fir		Western hemlock	
					Foliar injury ^y (%)	Height ^x (cm)	Foliar injury ^y (%)	Height ^x (cm)
Indaziflam	5 fl.oz	0.065	PRE	71 bc	0.5 fg	26.6 a	1.5 de	17.6 a-d
Mesotrione	6 fl.oz	0.188	PRE	98 ab	2.8 bcd	26.3 a	4.5 a	16.3 bcd
Dithiopyr	12 fl.oz	0.188	PRE	83 abc	1.3 d-g	28.3 a	1.5 de	18.0 a-d
Flazasulfuron	2 oz	0.031	PRE	91 abc	2.8 bcd	25.1 ab	2.0 cd	21.0 a
Pendimethalin + dimethenamid-p	200 lb (granule)	200 (total)	PRE	87 abc	2.3 b-f	26.2 a	1.5 de	20.2 ab
Isoxaben	11 oz	0.516	PRE	97 ab	2.3 b-f	28.2 a	1.3 def	18.1 a-d
Oxyfluorfen	1 pt	0.5	PRE	93 abc	0.8 efg	28.3 a	2.1 cd	19.1 abc
Trifluralin + isoxaben	100 lb (granule)	100 (total)	PRE	89 abc	1.5 c-g	25.3 ab	1.5 de	20.2 ab
Flumioxazin	8 oz	0.25	PRE	88 abc	3.3 bc	24.9 ab	4.0 ab	14.7 d
Flumioxazin + pyroxasulfone	8 oz	0.38 (total)	PRE	96 ab	2.5 b-e	24.8 ab	3.0 bc	17.1 a-d
Imazamox	5 fl.oz	0.039	POST	0 d	2.5 b-e	27.2 a	2.0 cd	17.9 a-d
Fluroxypyr	10.7 fl.oz	0.125	POST	18 d	0.5 fg	24.1 ab	0.5 ef	20.1 ab
Nontreated	---	---	---	20 d	0.0 g	21.3 b	0.5 ef	20.2 ab
Hand-weeded	---	---	---	98 ab	0.0 g	25.5 ab	0.0 f	17.9 a-d
Mesotrione + mesotrione	6 fl.oz + 6 fl.oz	0.188 + 0.188	PRE + POST	99 ab	2.8 bcd	25.9 ab	4.5 a	20.3 ab
Mesotrione + mesotrione	8 fl.oz + 8 fl.oz	0.25 + 0.25	PRE + POST	98 ab	2.5 b-e	26.8 a	5.3 a	21.1 a
Mesotrione + mesotrione	12 fl.oz + 12 fl.oz	0.375 + 0.375	PRE + POST	100 a	3.8b	28.3 a	4.8 a	15.1 cd
Saflufenacil	1 oz	0.044	PRE	68 c	7.7 a	21.8 b	1.5 de	17.4 a-d

Means within a column followed by the same letter or not followed by a letter are not significantly different (LSD0.05).

^zTreatments were applied May 23 preemergence (PRE) and July 29 postemergence (POST).

^yFoliar injury was rated June 26, weed control was rated July 29.

^xHeight of ten trees was measured July 29.

Table 5. Effect of early-season herbicides at harvest of Douglas-fir at Aurora Forest Nursery (2011).

Treatment ²	Rate (product/a)	Rate (lb ai/a)	Timing	Shoot ^y (g)	Root ^y (g)	Height ^y (cm)	Caliper ^y (mm)
Indaziflam	5 fl.oz	0.065	PRE	214 a	110 ab	33.0 ab	6.4 a
Mesotrione	6 fl.oz	0.188	POST	175 abc	93 abc	31.0 ab	5.9 abc
Dithiopyr	12 fl.oz	0.188	PRE	184 abc	93 abc	34.0 ab	5.8 a-e
Flazasulfuron	2 oz	0.031	PRE	188 abc	119 ab	31.5 ab	6.0 ab
Pendimethalin + dimethenamid-p	200 lb (granule)	200 (total)	PRE	166 abc	101 ab	32.5 ab	5.4 b-e
Isoxaben	11 oz	0.516	PRE	201 a	124 ab	35.8 a	5.5 a-e
Oxyfluorfen	1 pt	0.5	PRE	198 ab	106 ab	35.8 a	6.0 ab
Trifluralin + isoxaben	100 lb (granule)	100 (total)	PRE	143 bc	135 a	30.0 b	5.0 de
Flumioxazin	8 oz	0.25	PRE	198 ab	106 ab	34.1 ab	6.0 ab
Flumioxazin + pyroxasulfone	8 oz	0.38 (total)	PRE	201 a	109 ab	33.8 ab	6.0 ab
Imazamox	5 fl.oz	0.039	POST	141 bc	83 bc	30.9 ab	4.9 e
Fluroxypyr	10.7 fl.oz	0.125	POST	135 c	78 bc	29.6 bc	5.0 cde
Nontreated	---	---	---	164 abc	103 abc	31.9 ab	5.7 a-e
Hand-weeded	---	---	---	160 abc	108 ab	33.1 ab	5.8 a-e
Mesotrione + mesotrione	6 fl.oz + 6 fl.oz	0.188 + 0.188	PRE + POST	174 abc	141 a	30.0 b	5.8 a-d
Mesotrione + mesotrione	8 fl.oz + 8 fl.oz	0.25 + 0.25	PRE + POST	189 abc	115 ab	32.4 ab	5.9 a-d
Mesotrione + mesotrione	12 fl.oz + 12 fl.oz	0.375 + 0.375	PRE + POST	215 a	116 ab	34.0 ab	6.1 ab
Saflufenacil	1 oz	0.044	PRE	65 d	55 c	24.9 c	4.1 f

Means within a column followed by the same letter or not followed by a letter are not significantly different (LSD0.05).

² Treatments were applied May 23 preemergence (PRE) and July 29 postemergence (POST).

^y Shoot and root weight, shoot height, and stem caliper were measured October 17.

Table 6. Effect of early-season herbicides at harvest of western hemlock at Aurora Forest Nursery (2011).

Treatment ²	Rate (product/a)	Rate (lb ai/a)	Timing	Shoot ^y (g)	Root ^y (g)	Height ^y (cm)	Caliper ^y (mm)
Indaziflam	5 fl.oz	0.065	PRE	51 e	53	34.0 fg	4.2
Mesotrione	6 fl.oz	0.188	POST	118 bcd	88	38.3 b-f	4.3
Dithiopyr	12 fl.oz	0.188	PRE	126 abc	239	38.8 b-f	4.5
Flazasulfuron	2 oz	0.031	PRE	170 a	193	38.5 b-f	4.6
Pendimethalin + dimethenamid-p	200 lb (granule)	200 (total)	PRE	119 bcd	88	37.9 b-f	5.1
Isoxaben	11 oz	0.516	PRE	161 ab	99	38.0 b-f	5.0
Oxyfluorfen	1 pt	0.5	PRE	138 abc	104	41.0 abc	4.8
Trifluralin + isoxaben	100 lb (granule)	100 (total)	PRE	125 abc	100	40.6 a-d	4.5
Flumioxazin	8 oz	0.25	PRE	123 bc	83	39.1 b-d	4.9
Flumioxazin + pyroxasulfone	8 oz	0.38 (total)	PRE	139 abc	79	42.9 ab	5.0
Imazamox	5 fl.oz	0.039	POST	106 cd	90	34.4 efg	4.6
Fluroxypyr	10.7 fl.oz	0.125	POST	74 de	70	32.6 g	3.9
Nontreated	---	---	---	119 bcd	90	37.0 c-g	4.5
Hand-weeded	---	---	---	73 de	75	35.9 d-g	3.7
Mesotrione + mesotrione	6 fl.oz + 6 fl.oz	0.188 + 0.188	PRE + POST	124 abc	95	35.8 d-g	4.4
Mesotrione + mesotrione	8 fl.oz + 8 fl.oz	0.25 + 0.25	PRE + POST	120 bcd	90	34.5 efg	4.4
Mesotrione + mesotrione	12 fl.oz + 12 fl.oz	0.375 + 0.375	PRE + POST	99 cd	73	32.7 g	4.2
Saflufenacil	1 oz	0.044	PRE	160 ab	145	44.7 a	4.8

Means within a column followed by the same letter or not followed by a letter are not significantly different (LSD0.05).

² Treatments were applied May 23 preemergence (PRE) and July 29 postemergence (POST).

^y Shoot and root weight, shoot height, and stem caliper were measured October 17.

Summary

Even though injury was primarily at Mima only, it appears flumioxazin, flumioxazin + pyroxasulfone, imazamox, and fluroxypyr are potentially too damaging for use on Douglas-fir seedlings. At Aurora, trifluralin + isoxaben and saflufenacil were also marginally to excessively damaging to Douglas-fir seedlings, respectively, while mesotrione caused slight injury. Western hemlock was at least marginally injured by indaziflam, fluroxypyr, imazamox, and the split-applications of mesotrione, although hand-weeded and non-treated western hemlock also displayed slightly reduced growth. A second season of data on non-damaging herbicides from 2011 was collected and will be published as soon as possible. These data will help to determine the potential for registration of those products in conifer seedling nurseries.

References

- Masters C. 2009. Personal communication. Weyerhaeuser technologist, retired.
- Washington State Department of Agriculture. 2013. Plant Quarantines and Noxious Weeds. http://agr.wa.gov/plantsinsects/plantquarantines/plantquarantines.aspx#STATE_NOXIOUS_WEED_LIST (accessed 26 Nov 2013).
- Weiland JE, Leon AL, Edmonds RL, Littke WR, Browning JE, Davis A, Beck BR, Miller TW, Cherry ML, Rose R. 2011. The effects of methyl bromide alternatives on soil and seedling pathogen populations, weeds, and seedling morphology in Oregon and Washington forest nurseries. *Can. J. For. Res.* 41:1885–1896.

Root Zone Heating Systems

John W. Bartok

John W Bartok, Jr., Extension Professor Emeritus & Agricultural Engineer, Department of Natural Resources & the Environment, University of Connecticut, Storrs CT, 06269-4087; E-mail: jbartok@rcn.com

Bartok, JW Jr. 2014. Root Zone Heating Systems. In: Wilkinson KM, Haase DL, Pinto JR, technical coordinators. National Proceedings: Forest and Conservation Nursery Associations—2013. Fort Collins (CO): USDA Forest Service, Rocky Mountain Research Station. Proceedings RMRS-P-72. 62-65. Available at: http://www.fs.fed.us/rm/pubs/rmrs_p072.html

Abstract: Increased earliness and higher quality crops can be achieved using root zone heating. If the root zone temperature is maintained at the optimum, air temperature in the greenhouse can be lowered 5 to 10 °F (about 2 to 5 °C) reducing heat loss and thereby, energy consumption. Root zone temperature is more critical than leaf temperature in achieving good plant growth.

Key Words: seedling production, propagation, water heater, energy savings, temperature management, crop development

System Components

A typical hot water root zone heating system contains piping, a water heater or boiler, circulating pumps, and controls.

The least expensive pipe is polyethylene which is available in 100 ft (30.5 m) and 400 ft (122 m) rolls. Select a pipe made of virgin plastic rather than one having reconstituted resins. It should have a pressure rating of at least 100 psi. Polyethylene will take temperatures up to 130 °F (54 °C). Most growers who use poly pipe operate with a water temperature of 100 °F (37.8 °C) to provide 70 to 75 °F (21 to 24 °C) soil temperature. Nylon fittings and stainless clamps will minimize the potential for leaks. Fittings that are buried below ground should have double clamps. This pipe is best used with glass lined hot water tanks as it does not contain an oxygen barrier.

Semi-rigid polyvinyl chloride (PVC) is also low cost. It is available in 10 ft and 20 ft (approx. 3 m and 6 m) lengths, which makes installation easy. Fittings are connected with pipe cement.

Commercially available systems are available that use ethylene propylene diene monomer (EPDM) rubber tubing either as single tubes or as two or four tubes attached to a web. Diameters of $\frac{3}{8}$ in or $\frac{1}{2}$ in (0.95 to 1.3 cm) have greater heat transfer and eliminate some problems from chemical coating and sedimentation blocking. The tubing is connected to plastic or copper headers with plastic inserts or brass fittings. Some manufacturers offer custom made, ready to install modules with headers sized to fit the row spacing.

Cross-linked polyethylene (PEX) tubing (a cross-linked polyethylene tubing with an oxygen diffusion barrier) will take higher temperature and pressure and protect corrodible components of a closed loop hydronic heating system. It is available in $\frac{1}{2}$ in, $\frac{3}{8}$ in and $\frac{3}{4}$ in (1.3, 1.6 and 1.9 cm) diameter. It is highly tolerant to freeze conditions.

System Layout

PVC pipe is the most common material for the supply piping to bring the water from the heater or boiler to the growing area. A reverse return (3 pipe) system is used so that the water to all the loops travels the same distance. On long runs and in unheated areas, supply and return pipes should be insulated to save energy.

For EPDM rubber installations, follow the manufacturer's recommendations for spacing, length of run and circulating pump size. The tubing can be buried in sand on the floor or placed on top or underneath the bench. Some manufacturers supply a slotted insulation board for placing the tubing on top of the bench.

For soil grown crops, placing the pipe 8 to 12 in (20 to 30.5 cm) deep will allow roto-tilling of the soil above it. This can be done by plowing a furrow and then laying the pipe in the bottom or purchasing a pipe-laying chisel that attaches to the drawbar of a tractor. For surface installation with bags or troughs, the pipe is laid on top of the ground plastic or weed barrier underneath the plants.

For benches, a 6 to 9 inch (15 to 23 cm) pipe spacing covered by 3 to 4 inches (7.6 to 10 cm) of sand will provide even temperature. The sand should be kept wet to transfer the heat and is usually covered with a sheet of plastic or weed barrier. An alternative arrangement consists of laying the pipe in the bottom of the bench and covering it with wire mesh and a layer of plastic. Some growers have attached the pipe underneath the bench to get it out of the way and to allow for better heat spread.

The pipe is installed as loops fed by a supply header with the other end connected to a return header. Using a reverse return system, the flow through each loop travels the same distance giving uniform heating (figure 1). Heat loss from plastic and rubber tubing is relatively slow so lengths up to 200 ft for 1/2 inch and 400 ft for 3/4 inch pipe will give good results with minimum friction loss. The size of the loops should be made as large as practical so that the header and pump size can remain small. To keep an even flow of water within the pipes and eliminate air pockets a flow rate of 2 and 2.5 gallons/minute (gpm) is used for the 1/2 inch and 3/4 inch pipe, respectively.

Sizing the Heater

For crops grown in rows in the soil or in bags with a single line of pipe under each row, you can estimate that it takes 10 Btu/linear foot of row length. For example, a 30 ft x 100 ft (9 x 30 m) greenhouse with 10 rows of plants would require 10,000 Btu/hr of heat (10 rows x 100 ft length x 10 Btu/hr/linear ft). Add about 10% to this total for heat loss from the supply pipes. The soil around the pipes needs to be kept moist to get good heat transfer.

Heat loss from beds or benches covered with plants growing in the soil is about 20 Btu/sq ft/hr and for beds or benches covered with flats, about 15 Btu/sq ft-hr. This is based on a water temperature of 100 °F (37.8 °C). Some manufacturers of rubber tubing recommend water temperature as high as 140 °F (60 °C), which will increase heat transfer but may cause root damage on some crops.

Heat Source

A tank-type, domestic hot water heater (30,000 to 40,000 Btu/hr) fired by natural gas or propane will provide the root zone heat for 3,000 to 5,000 sq ft (279 to 465 sq m) of growing area (figure 2). Commercial water heaters fired by gas or oil are available in larger sizes. As the root zone heating system does not provide all the heat needed to keep the greenhouse warm on cold nights, a unit heater or other source of air heat is needed.

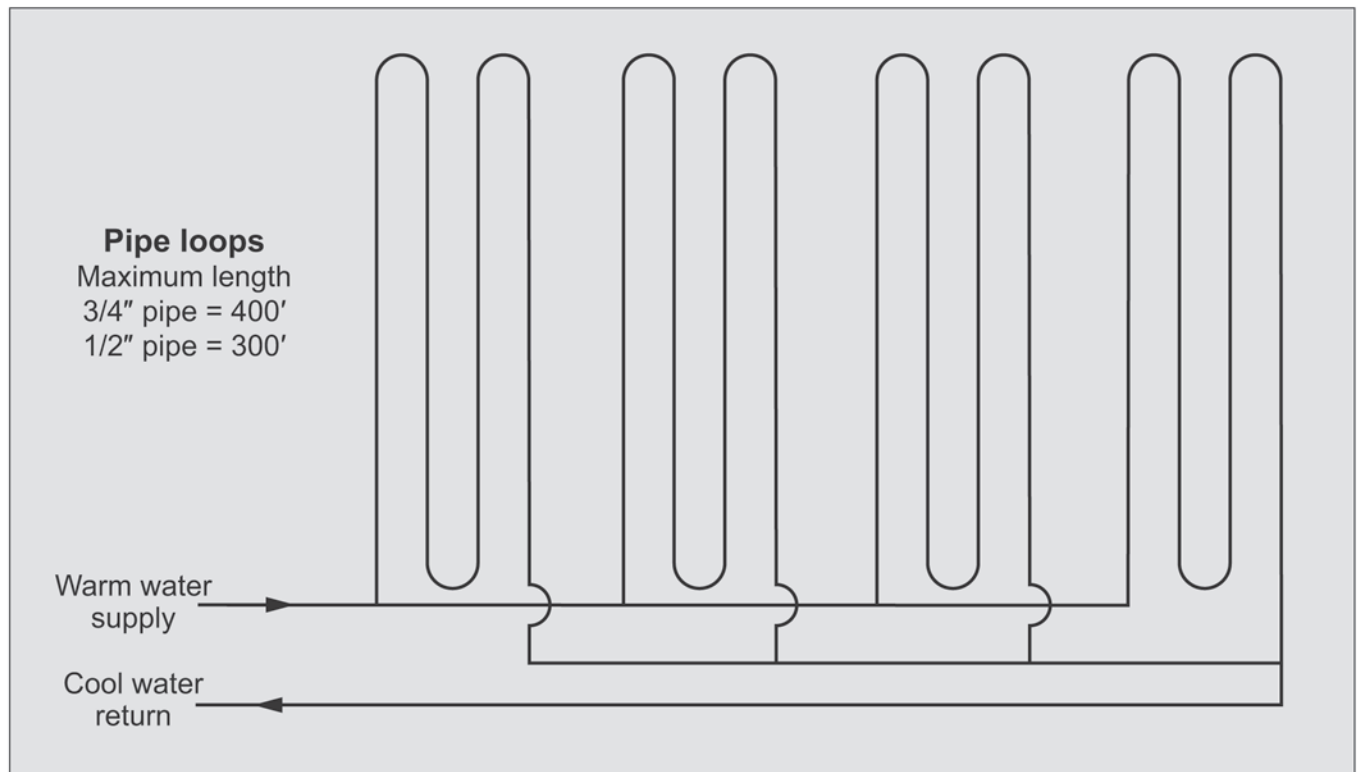

Figure 1. Typical reverse return pipe layout for floor or bench heat.

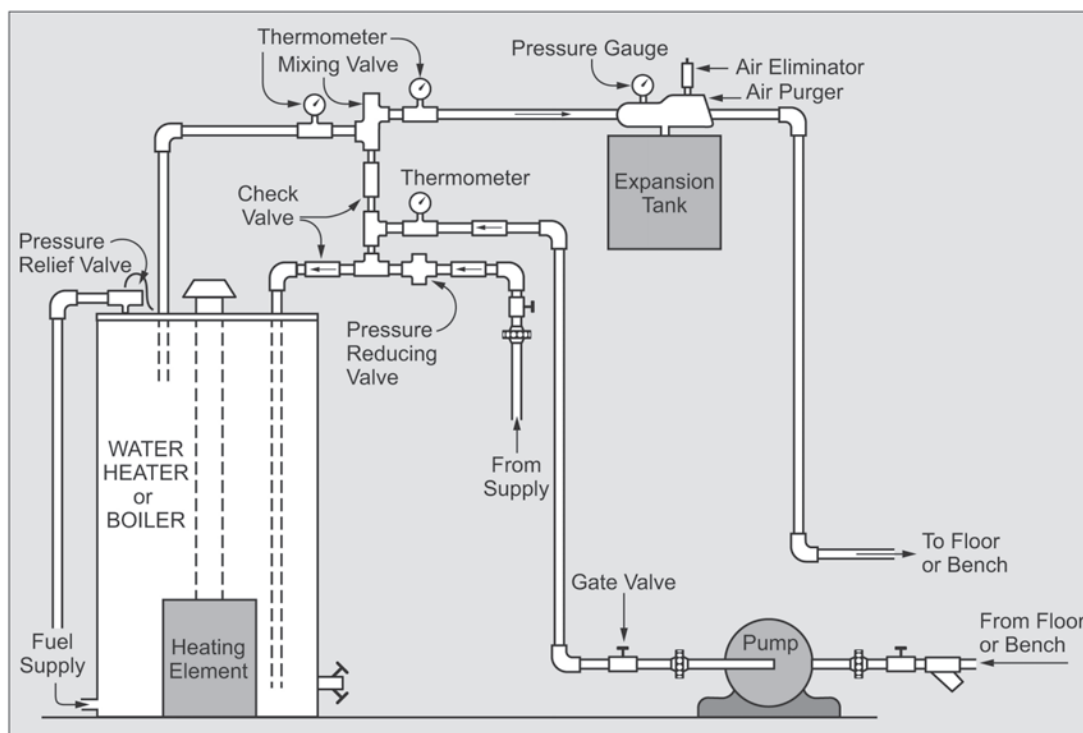

Figure 2. Piping schematic for bottom heat system.

In larger greenhouses, a boiler is usually installed that is large enough to provide both the root zone heat and the air heat. It is best if dual boilers are installed with 1/3 and 2/3 capacities. These can be staged to efficiently handle the heat needs over the entire year. The boiler water temperature is usually maintained at 180 to 200 °F (82 to 93 °C) during the coldest part of the year. A tempering valve installed in the supply line mixes the hot water and the returning cool water from the root zone piping to provide the 100 °F (37.8 °C) water for the system. Boilers are available in sizes from 50,000 Btu/hr and up.

System Plumbing

All closed loop systems require the use of a pre-pressuring diaphragm expansion tank, an air eliminator and vent installed on the supply pipe as close to the hot water source as possible. Valves needed include a pressure relief valve, flow balancing valves, gate valves to isolate parts of the system, pressure reducing valves to fill the piping and zone valves to control individual sections of the system independently.

Water is moved through the system with circulating pumps. The flow rate is based on the number of loops per zone and the size of the piping (figure 3). For example, a system of 10 – 200 ft loops of ½ inch poly pipe will have a flow of 20 gallons/min (10 loops x 2 gpm/loop = 20 gpm). The pump needs to be able to overcome the friction loss in the system. For most root zone systems, a pump having the calculated capacity at a total of 15 to 20 feet of head will meet the system needs. Heat supplied from root zone systems depend on whether the pipe is in the soil or under flats of plants (figure 4). It also depends on whether the soil next to the pipe is moist. Moist soil transmits a greater amount of heat.

Controls

In the simplest system using a water heater, the thermostat on the tank is set at the desired root zone water temperature (usually 100 °F/37.8 °C). Return water from the loops goes back to the tank to be reheated. The same system can be used with most boilers by setting the aquastat that controls the output water temperature. Manufacturer's guidelines for minimum water temperature entering the boiler should be strictly followed. Where a boiler is used for space heating in addition to root zone heat, a higher temperature is usually desired and a mixing valve needed. In most areas of the US, root zone heat will provide less than 25% of the total greenhouse heat needs on the coldest night so an additional heat distribution system is needed. This can be fin or pipe radiation, water to air heat exchangers, or hot air furnaces.

Activation of the circulating pump is done with a sensor inserted in the soil or growing bag. An electronic thermostat is a good choice as the differential between on and off is only a degree or two. Most mechanical thermostats have a higher differential.

In larger greenhouse systems, the water in the supply lines to the root zone system may be circulated continuously. This maintains warm water near the growing area. Solenoid valves on each zone, activated by a sensor in the bed, control the flow to that zone.

Summary

Root zone heat has proven to be an effective way to get better propagation and production. Energy savings due to a lower air temperature can be as much as 10% and help offset the cost of the system.

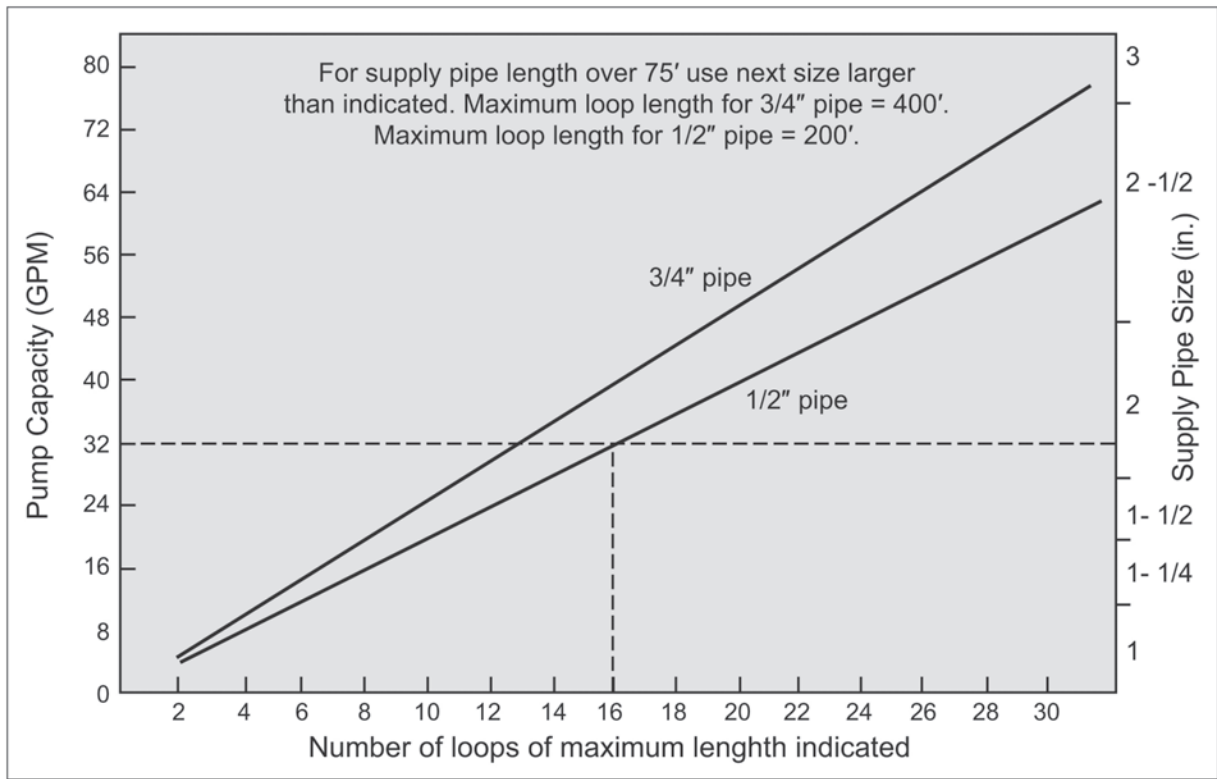

Figure 3. Pump capacity and supply header size for polyethylene pipe bottom heat system.

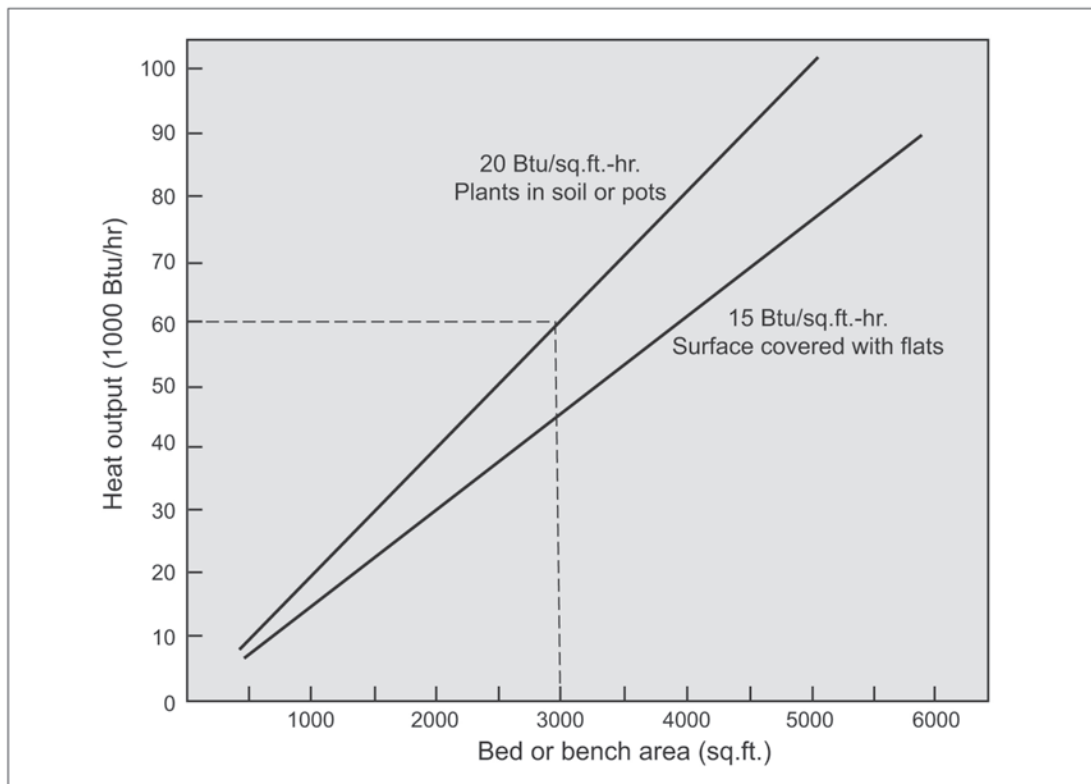

Figure 4. Heat flow from bottom heat in floors or benches.

Beyond Cowboy Science: Simple Methods for Conducting Credible and Valid Research

Diane L Haase

Diane L Haase, Western Nursery Specialist, USDA Forest Service, PO Box 3623, Portland, OR 97208; E-mail: dlhaase@fs.fed.us

Haase DL. 2014. Beyond Cowboy Science: Simple Methods for Conducting Credible and Valid Research. In: Wilkinson KM, Haase DL, Pinto JR, technical coordinators. National Proceedings: Forest and Conservation Nursery Associations—2013. Fort Collins (CO): USDA Forest Service, Rocky Mountain Research Station. Proceedings RMRS-P-72. 66-77. Available at: http://www.fs.fed.us/rm/pubs/rmrs_p072.html

Abstract: Many nursery and field trials are conducted every year to test new products and techniques. Some of these trials, however, can produce data that is too variable or confounded to accurately assess the question(s) of interest. A “cowboy science” approach can yield results that are statistically invalid and/or biologically untrue; using such data can lead to erroneous conclusions. By incorporating a few simple, basic principles of study design and data collection, anyone can yield credible data that can be used to answer questions or make decisions. Despite beliefs to the contrary, using a valid experimental design usually requires little or no additional input of time and resources, nor does it require an in-depth understanding of statistics. Good research design also ensures that the time and resources invested in research yields meaningful results. This paper describes the “Three Rs” of study design – Representation, Replication, and Randomization – along with examples of pitfalls and successes. It also describes how to create a study plan to guide effective research in the nursery or the field.

Key Words: experimental design, confounding, bias, research methods, data collection.

What is Cowboy Science?

The term “Cowboy Science” was coined many years ago by northwest foresters to refer to “quick and dirty” trials or “demo plots” established operationally to evaluate a technique or treatment (Rose 2000). In no way is this meant to be derogatory to cowboys—quite to the contrary! This term is a nod to the stereotypical cowboy’s independence and resourcefulness in solving problems. Many foresters and other field professionals lack the background or confidence to set up a research project based on statistical theory and design, but most have the intelligence, professional curiosity, and creativity to practice Cowboy Science on occasion. Over the decades, an enormous amount of time, land, and resources have been dedicated to investigating seedling growth in the nursery and after outplanting in response to new products or techniques.

Cowboy Science can be helpful for generating some preliminary observational data used for initial exploration of simple research questions. Such data, however, are considered “anecdotal” and insufficient to adequately or accurately assess the question at hand. Drawing conclusions from such data can be risky.

Risks Associated with Cowboy Science

The inherent characteristic of Cowboy Science is its disregard for experimental methods designed to generate valid data for addressing study objectives. This approach can yield results that are statistically invalid or biologically untrue. Using such data can lead to erroneous conclusions. Using flawed results is especially problematic (and costly) when making management decisions.

Example #1

Cowgirl Jane set up a nursery study to test two products that the manufacturer claims will increase root growth. She applied the products to two nursery beds in an out-of-the-way area of the nursery. Each nursery bed had seedlings from a different low-demand seed lot. She chose these seed lots because she did not want to take the chance of having a negative effect on one of the seed lots she regularly grows in the nursery. She applied Product A to one nursery bed and Product B to the adjacent nursery bed. After several months, she measured 50 of the largest seedlings in each bed and found that those treated with Product B grew more than those treated with Product A. Based on this result, she decided to order Product B for her entire crop. So, what is the problem with Cowgirl Jane's study?

The problem with the study design that Cowgirl Jane used is that conditions in the study area were not uniform. There is a different

seed lot in each nursery bed, and the irrigation patterns result in one bed receiving more water than the other (figure 1). The growth differences she observed could have been due to differences in seed lot or water availability, and therefore have nothing to do with the product she was testing. Additionally, because the treatments were applied to seedlots that are infrequently grown and the study was carried out in an infrequently used area of the nursery, it would be unwise to assume that other seed lots in other areas of the nursery will respond similarly to the treatments. Another issue is that she did not include a control treatment so there is no way to determine if using either of the products results in better or worse root growth than what she does already. Furthermore, data was collected only on the largest seedlings so it is difficult to conclude that the treatment difference is likely to occur throughout the group of seedlings.

Example #2

Cowboy Joe set up a study to compare growth of seedlings from five different nurseries.

He established 5 plots (one per nursery), each with 100 seedlings, on his site. He chose a typical reforestation site to ensure that the study simulated his operational practices. From the onset, he was confident that seedlings from Nursery C or Nursery E would outperform the others. After 3 years, he found that seedlings from nursery C grew the most and decided to sign a large contract with that nursery. So, what is the problem with Cowboy Joe's study?

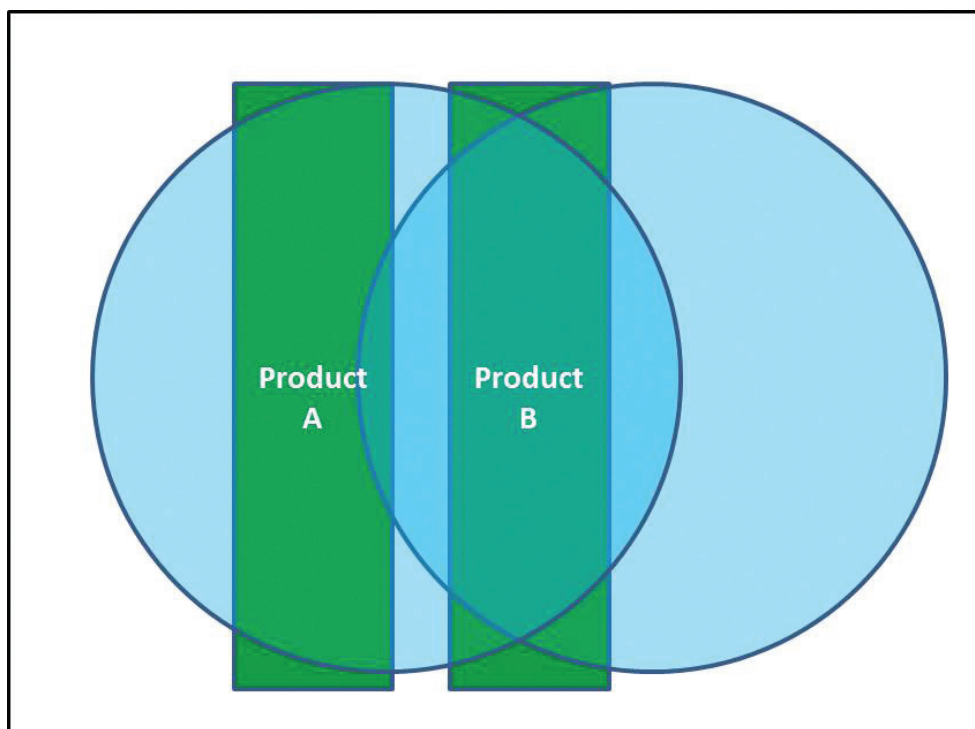

Figure 1. In this Cowboy Science example, a study was installed to compare effects on seedling development of Products A and B applied to two nursery beds. Irrigation patterns, different seed lots, and the lack of a control treatment, however, resulted in confounding and an inability to accurately assess responses to the two products.

The problem with the study design that Cowboy Joe used is similar to the problem with Cowgirl Jane's study design in Example #1—conditions in the study area were not uniform. Because of the variability on the site, conditions in some of Cowboy Joe's plots were more favorable for seedling growth compared to conditions in other plots. Part of the study area was covered with a berry thicket, another part was located where there had been a burn pile, and another part was adjacent to a mature forest resulting in increased browsing and shading (figure 2).

This study design is akin to the adage of having all of one's eggs in one basket—if something goes wrong in one plot, then the study is irreparably compromised. For example, if most of the seedlings in the plot adjacent to the mature forest are severely browsed, then that plot, containing all of the seedlings from one of the nurseries, is effectively eliminated from the study. In addition to the observable variation on the site, there could also be hidden factors such as gradients in soil depth, moisture, fertility, texture, and drainage.

Given the variability on the site, it would be risky for Cowboy Joe to conclude that seedling performance from one nursery is superior to seedlings from other nurseries when, in fact, site conditions may be the primary factor influencing differences in growth and survival among the plots. Furthermore, Cowboy Joe's prejudice in favor of two of the nurseries may have inadvertently swayed the study setup and data collection.

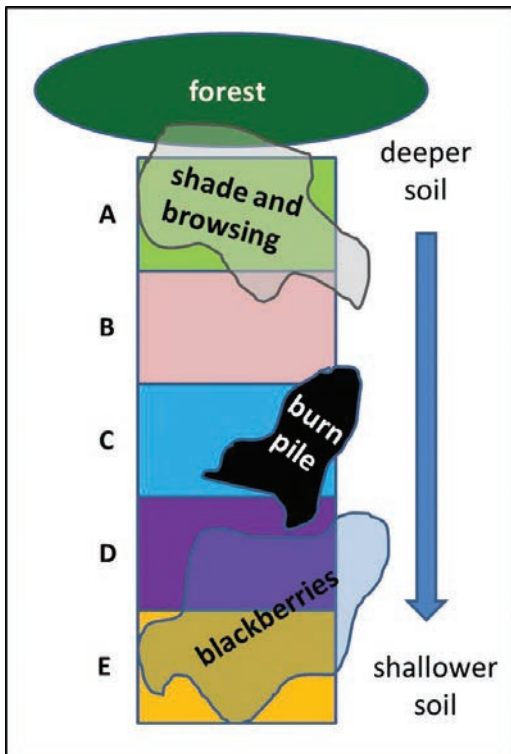

Figure 2. In this Cowboy Science example, five plots were established on a field site to compare seedling growth from five different nurseries (A, B, C, D, and E), but variation in site conditions likely had a greater influence on field performance than the originating nursery. Data from this study design can lead to incorrect conclusions and faulty management decisions.

Confounding and Bias

With regard to study design, confounding and bias can be defined as follows (Dictionary.com 2013a, 2013b):

Confounding—

- to throw into confusion or disorder
- to treat or regard erroneously as identical
- to mix or associate by mistake
- to mingle so that the elements cannot be distinguished or separated

Bias—

- a tendency or inclination, especially one that prevents unprejudiced consideration of a question
- a systematic distortion of a statistic as a result of sampling procedure
- to cause partiality or favoritism in
- to influence, especially unfairly
- selectivity in a sample which influences its distribution and so renders it unable to reflect the desired population parameters

In Cowboy Science, confounding and bias can result in differences among treatments that are not actually due to the treatment. In Example #1, it is impossible to isolate the influences of irrigation pattern, seed lot, and treatment application because those factors are confounded with each other. Furthermore, data in Example #1 that were collected only from the largest seedlings resulted in a biased dataset. In example #2, the effects of nursery source were confounded with the site conditions and the researcher's bias toward the study's outcome may have influenced its design and outcome.

Other Pitfalls of Cowboy Science

In addition to confounding, the Cowboy Science approach often has other aspects that can result in misleading, erroneous, or limiting conclusions. Some of these are:

- **No control treatment** – any study should include a control treatment that allows one to determine how much better (or worse) the new method is compared to the usual way.
- **No study plan** – any study, small or large, needs to have a written plan regarding the objectives, methods, measurements, etc. This plan is important to stay on track and to keep others informed, especially if the person who set up the study is unable to continue it to completion.
- **No labeling or mapping** – it is important to have the study clearly labeled and mapped so that it can be re-visited for future measurements without any questions regarding plot and treatment identification.
- **No follow-through or maintenance** – it is a waste of time and effort to set up a study only to abandon it later due to changes in personnel, poor time management, lack of documentation, or inadequate maintenance of the plots.
- **Too many treatments** – trying to compare too many treatments or treatment combinations (for example, several species treated with different fertilizer types applied at different rates, etc.) can lead to data from which making any meaningful conclusions is challenging.

- **Too few trees per treatment** – *it is important to have enough trees (or other study subjects) in each treatment to generate an adequate amount of data from which averages and differences among averages can be calculated with confidence.*
- **An emphasis on being “operational”** – *although the study objective is to generate results that can be applied to operational practices, using an operational approach when conducting the study can result in excess variation. Any variation not attributable to the treatments or subjects being studied makes it difficult to isolate treatment effects and determine the maximum response potential.*

Variation is the Key

Setting up a study of any kind is all about controlling sources of variation. In fact, variation is the basis of most statistical calculations – analyzing variation within and among different groups to determine whether or not the groups differ from one another. For example, if you wish to compare heights for two groups of seedlings (such as groups by species, treatment, or some other factor) and the average height is 22 in (56 cm) for one group and 17 in (43 cm) for the other group, you would then examine the variation to determine if those two groups truly differ in height. If there is very little variation in the data (for example, most height measurements within each group fall within 1-2 in [2-5 cm] of their respective group’s average), then the conclusion would likely be

that the two groups are different. If the data varies quite a bit (for example, some height measurements are much higher and some are much lower than the average) then there is likely a lot of data overlap between the two groups and you cannot conclude that the two groups truly differ in height.

To generate valid and useful data, it is essential to maximize both its accuracy and its precision (figure 3), both of which can be significantly affected by how the study is designed and implemented. Variation created by bias, confounding, or outside influences can generate data that is inaccurate or inconclusive. Ultimately, the only desired source of variation is the variation resulting from the treatments or other factors being studied. Everything else is “noise.”

Since variation plays a fundamental role in the ability to compare different treatments or other factors, proper study design is critical. Understanding and controlling the causes and magnitude of variability are the key to generating data that can be used to make valid conclusions about the treatments or other factors being studied.

Treatments

The treatment is the one factor that is intentionally changed for the sake of the experiment. It is the factor that is expected to create a response. For example, a treatment could be fertilizer rates, fertilizer formulations, growing media components, species, seedling stocktypes, seed lot, planting method, or other treatments. All other factors must stay the same to be able to isolate responses to the treatment in question. So, unless the intent is to compare seed lots, species, planting dates, etc., all of those other factors must be the same throughout the study.

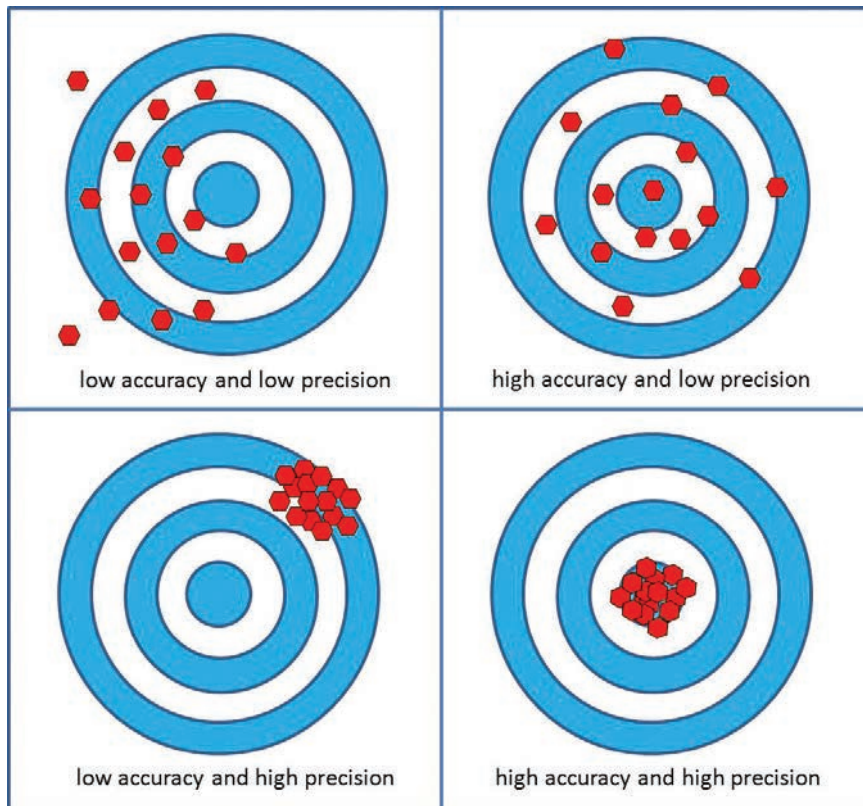

Figure 3. A good study design strives to eliminate bias, confounding, and other sources of variation in order to isolate treatment effects with accuracy and precision.

Control Treatment

Including a control treatment is an essential component of experimentation. The control treatment is the usual method of doing something. It is important to have a control treatment so responses to the modified method can be compared to the usual method.

Some studies may include two control treatments: the “do-nothing control” (where no product is applied to the crop) and the “operational control” (where the usual product or treatment is applied to the crop). Having an operational control is most common with pesticide trials in which new pesticide treatments are compared to the current pesticide in use as well as to a control treatment in which no pesticides are used at all.

Factorial Treatments

Studies can also be designed to evaluate two treatments (factors) at the same time. For example, fertilizer would be factor A and stocktype would be factor B. Factorial study designs allow you to determine if there are interactions between the two factors: is the response to fertilizer the same for every stocktype? For the design to be valid, all combinations of the two factors must be included. For instance, if there are three fertilizer rates (factor A) and three seedling stocktypes (factor B), then there needs to be a total of nine treatment combinations included in the study (3 rates x 3 stocktypes). A control level for each factor must be included as well.

Number of Treatments

While it may be tempting, including more than two factors or more than 10 treatment combinations will not increase the usefulness of a study. Keep it simple—do not include too many treatments and do not go beyond two factors. In fact, increasing the number of treatment comparisons in a study increases the odds of finding a difference when one does not exist. Furthermore, three-way (or more) interactions are very challenging to quantify and interpret. It is better to establish additional studies rather than try to answer too many questions in a single study.

The Three “Rs” of Study Design

Once the objectives have been defined for a study, details about the experimental design need to be established. A good study design does not have to be complicated, but all study designs need to incorporate the “Three Rs” – Randomization, Replication, and Representation. These Three Rs are important tools to control variation and generate valid data that can help answer the questions posed by the study.

Randomization

Randomization is the circumstance in which each experimental unit in the study has the same chance of being assigned to any of the treatments. The experimental unit is the basic unit to which the treatments are applied. This unit must be clearly defined (for example, individual trees, rows of trees, a pallet of seedlings, a field plot, a greenhouse bench, a nursery bed, a greenhouse). Individual trees are good for short-term studies in small areas with relatively uniform conditions. Plots are usually best for forest or nursery studies. The most common plot configurations are row, square, or rectangle plots. Square and rectangle plots are usually better for longer-term studies because they create a very small depiction of how the area would be if it was all treated in the same manner whereas row plots will have a greater influence from adjacent rows.

Randomization prevents bias, which can be defined as any process which tends to produce results or conclusions that differ systematically

from the truth. For instance, if treatments A, B, and C are assigned from left to right to a series of plots, then B is always left of A, and C is always left of B. If there is a gradient in soil or sunlight from left to right, then the trees might respond systematically different due to factors other than the treatment in question.

Following are some other examples of approaches that result in a biased study:

- *“This plot looks weedy; let’s put the vegetation control treatment here.”*
- *“This area is close to the road; let’s install the fertilizer treatments here so we don’t have to carry it up that hill”*
- *“These seedlings are smaller than the others; let’s put them in the plot with the highest irrigation treatment.”*
- *“These seedlings have nice foliage; let’s choose them for foliar sampling.”*

To implement randomization, assign treatments to trees or plots using a random, non-biased method. This can be accomplished by rolling a die, drawing a playing card, using a random-number generator, drawing treatment names/numbers out of a hat, or other methods. To save time and avoid on-the-ground bias, it is best to plan randomization in the office, prior to implementing the study in the nursery or field.

Replication

Replication is the most often neglected, yet most important, component of study design. Replication provides the ability to measure variation whether it is due to the treatments, the study subjects, or the physical conditions on the site. Failure to replicate renders it impossible to make valid comparisons between treatments. Without replication, all you have is a one-time event which may or may not be repeatable. For instance, if a cowboy successfully rides a bucking bull one time, how confident can we be that she or he will do so from now on? Making management decisions based on unreplicated data is just as risky as gambling on the rodeo cowboy who has only ridden the bull once.

Replication is achieved by applying each treatment to more than one experimental unit. As described above, experimental units can be individual trees but are more often field plots, nursery benches, or other units composed of several seedlings. It is important to distinguish that the trees within a plot (or other multi-tree unit) are the sampling units whereas the plot itself is the experimental unit. The most common mistake regarding replication occurs when the sampling units are regarded as replicates when in fact, they are not. This error results in pseudo-replication.

Statistical procedures exist for determining the ideal number of replicates for a given study based on how much variance is expected. Statistical calculations are beyond the scope of this paper, however, and mathematical determinations of study size are not often used for field studies. The most important thing to know is that more replicates are always better than less. Having more replicates (while still keeping the study at a manageable size) increases the study’s ability to detect whether or not there are significant differences among groups. When determining the number of replicates (experimental units) and plot size (number of sampling units), various factors need to be considered such as expected survival, duration of the study, and type of measurements (nondestructive vs. destructive). When individual trees are used as replicates, I recommend a minimum of 25 trees in each treatment (50 or more if possible). When plots are used, I recommend a minimum of 4 plots per treatment, each with a minimum of 10 trees. As stated previously, however, more is better; the study design I have used most often is 5 plots of 25 trees per treatment.

Representation

Common sense tells us to compare apples to apples rather than apples to oranges. This is also a basic tenet of good study design. When designing a study, it's important to be aware of its "scope of inference" - the population and circumstances to which the results can be applied. The study should be conducted such that the results are applicable to the specific trees or situations of interest. For instance, if the objective is to apply the study results to pine trees on high elevation sites, then it would be imprudent to conduct the study with oak trees or on low elevation sites because oak trees and low elevation sites do not represent the situation defined in the study objectives.

To ensure that the study design is adequately representative, select treatments, experimental materials, sites, timing, and situations that best represent the desired scope of inference. By ensuring representation, you can confidently apply the results to specific populations and circumstances.

Incorporating the Three "Rs" into Study Design

There are numerous study designs. For purposes of this paper, however, I will describe the two most common designs used in reforestation and nursery studies.

Completely Randomized Design

The completely randomized design (CRD) is one of the simplest study designs. A representative population of trees (or other study subjects) and site(s) are designated for the study. Within the representative population, trees are randomly selected to be included in the study. These trees are then replicated by individual trees or in plots and randomly assigned to a treatment (figure 4).

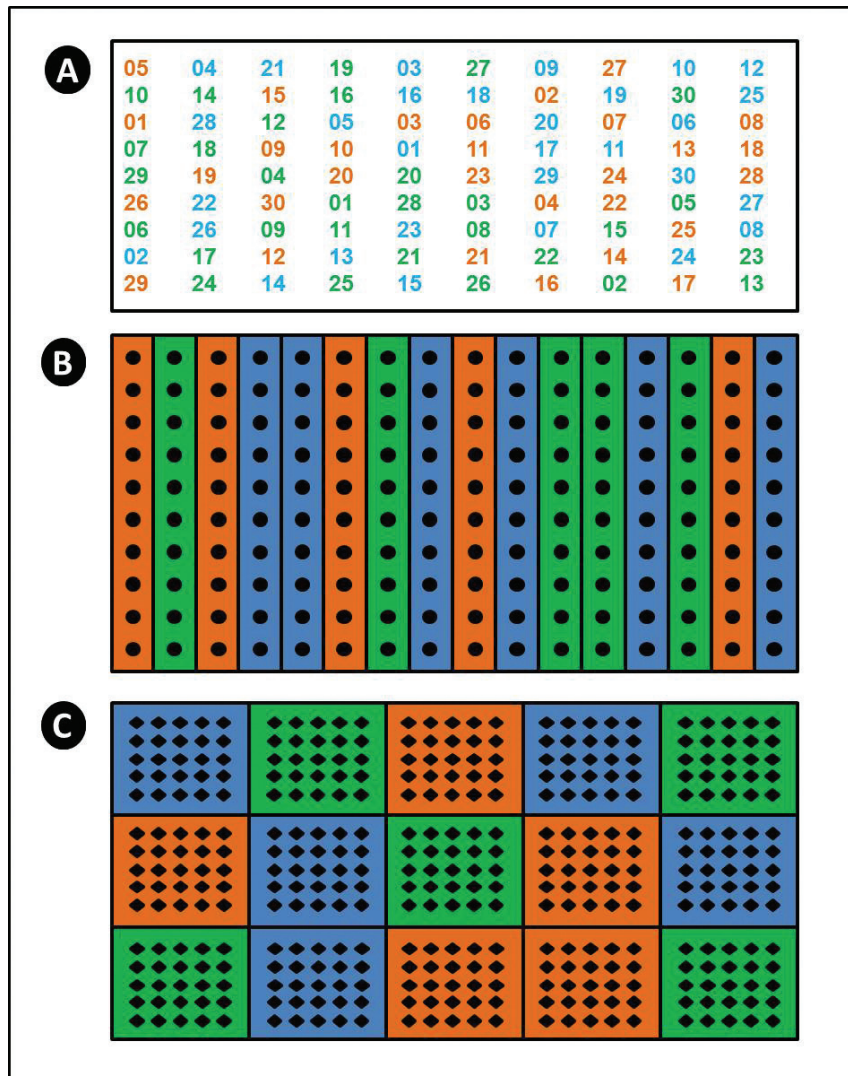

Figure 4. Examples of completely randomized designs to assess three treatments (illustrated here with three shades) using single-tree replicates (A), row plots (B), or square plots (C).

CRD should only be used in situations where conditions on the study site are expected to be homogenous (for example, inside one area of a greenhouse, in a bareroot nursery field, on a flat outplanting site with consistent ground cover, etc.). Although CRD is simple and efficient, it is not often used because researchers are often uncomfortable assuming conditions in their study area are truly uniform.

Randomized Complete Block Design

The randomized complete block (RCB) design is the most common design used in nursery and reforestation studies. This study design can be used under variable conditions (for example, typical outplanting sites, different soil types in a nursery, a series of greenhouses, etc.).

As with the CRD, representative study site(s) are chosen and trees (or other study subjects) are randomly selected from a representative population to be included in the study. These trees are then replicated into treatment plots. One plot of each treatment is then grouped into a block. Trees are randomly assigned to each treatment plot and treatment plots are randomly assigned within each block (figure 5).

Each block in a RCB design is a replicate. For this design to be effective, conditions within each block should be as homogenous as possible but conditions among blocks can vary significantly. Blocks can be located adjacent to one another, spread throughout the site (figure 5), or even established on different sites. Blocking should be based on any condition or gradient that could affect treatment responses (for example, slope, drainage, soil type, aspect, vegetation, etc.).

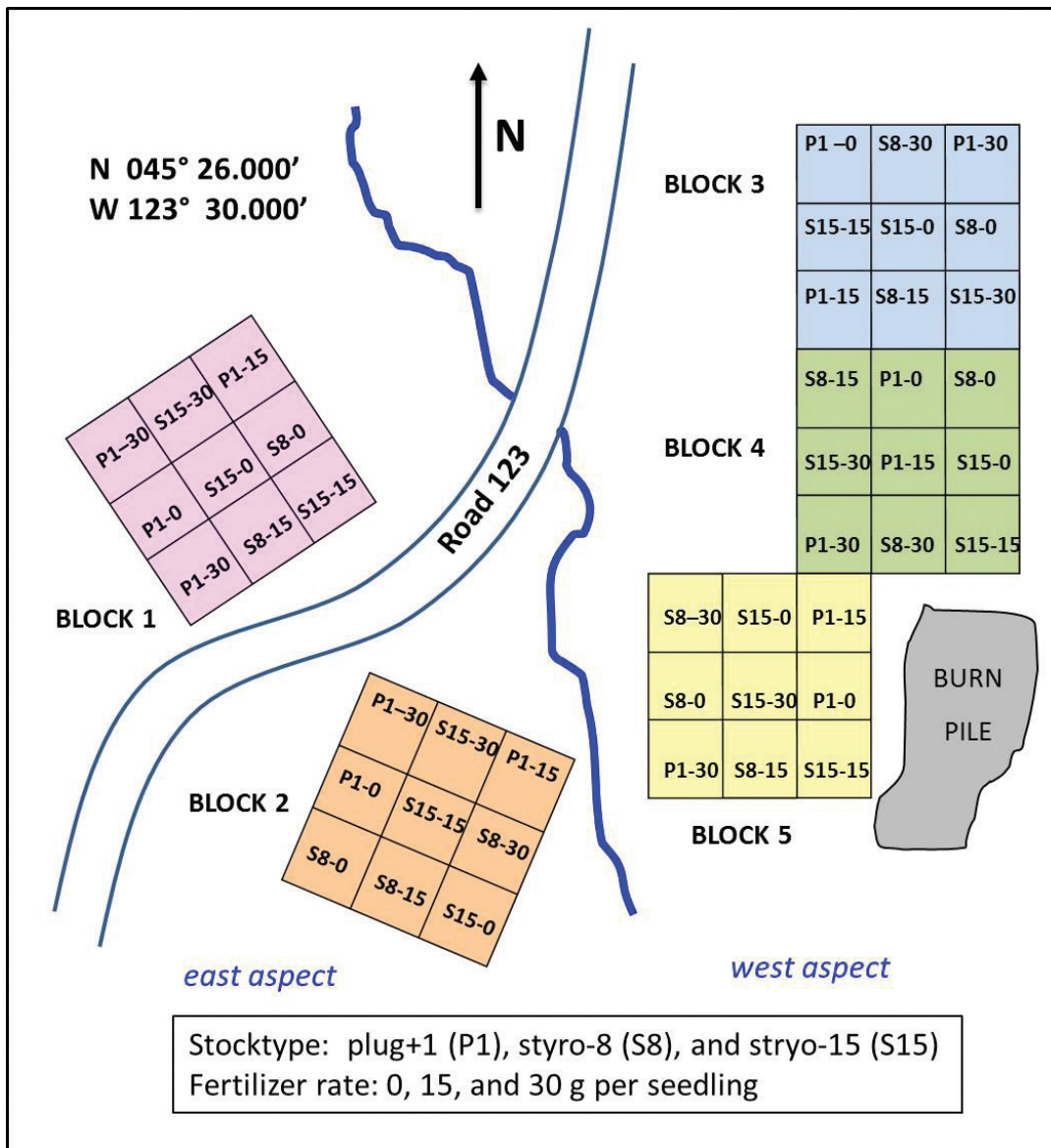

Figure 5. Example of a randomized complete block design with five blocks, each containing nine treatment plots. Note that this example shows 3 x 3 factorial treatments: 3 stocktypes (P1, S15, and S8) and 3 fertilizer rates (0, 15, and 30g [0, 0.5 and 1 oz]). This illustration is also a good example of mapping the site location and layout.

The great advantage of blocking is the ability to perform simple statistical analyses that can isolate the variation due to the treatments in question from the variation due to differences in conditions among blocks (that is, it can separate treatment effects from block effects). The RCB is actually a stronger design than the CRD because the treatments can be compared under a wider range of circumstances; if relative treatment responses are similar in all blocks, even though the rate or magnitude of response may vary due to block conditions, then there can be even greater confidence when making conclusions about treatment effects.

Example #1 Revisited

In Example #1, Cowgirl Jane’s study to test two products in her nursery had a variety of issues (figure 1). First of all, her treatments were confounded with seed lot and with the irrigation pattern in the two nursery beds. Secondly, the seed lots and test location were different than the crop to which she would like to apply the treatments operationally. Thirdly, she did not include a control treatment to enable determination of whether either of the treatments truly is better (or worse) than her existing practices. Lastly, data were collected only on the largest seedlings.

By incorporating the Three Rs into the study design, Cowgirl Jane’s study can be improved greatly. The treatments need to be applied to one representative seed lot in a representative location of the nursery. She can plan ahead to ensure that there will be excess stock available for the study. If she expects seed lots to respond differently to the treatments and wants to include more than one seed lot in the study, then seed lot will need to be a second factor included in the study design (see section describing factorial treatments). She needs to add a control

treatment to the study design and she needs to replicate the treatment plots. If she chooses an area that is relatively uniform (same irrigation pattern, cultural regime, etc. throughout) then she could set up the study in a CRD (figure 6A). Because there can be hidden variation in soil or other factors, however, she may prefer to set up the study in a RCB (figure 6B). Regardless of the study design she uses, the treatments need to be randomly assigned to each plot. These changes to her study design will result in a valid dataset that can isolate the seedling responses to the applied products and determine if they improve crop performance relative to the control. When it is time to collect data, she must randomly select seedlings for measurement from each treatment plot to avoid bias (see later section on Data Collection).

Example #2 Revisited

How can Cowboy Joe incorporate the Three Rs to improve his study design (figure 2)? Because there is a great deal of variation on his site, a good start would be to take steps to reduce variation as much as possible in the study area. He can establish the study plots away from the mature forest to reduce browsing and shading influences. He can also exclude the burn pile from the study area. In addition, he can take measures to control the blackberries. These extra efforts are above and beyond operational practices but are necessary to eliminate excess variation, thereby increasing the data’s accuracy and precision. Cowboy Joe cannot rid the site of all variation (such as soil depth) but by using a RCB design with five replications (blocks) and 20 seedlings in each treatment plot, he can better isolate seedling growth differences due to nursery of origin from growth differences due to site conditions (figure 7). He can also eliminate his own bias about the study outcome by randomly assigning seedlings to plots ahead of time.

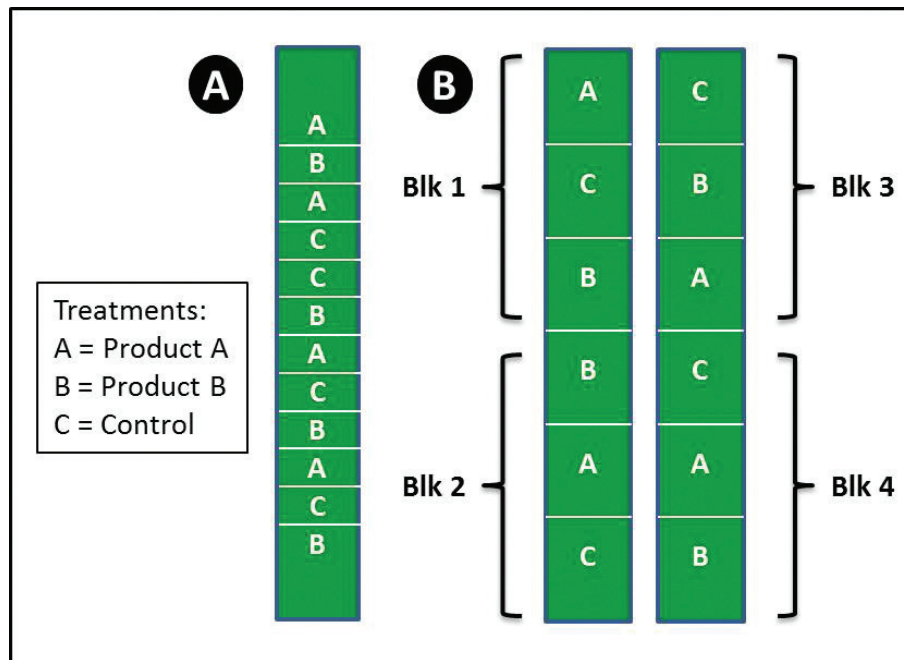

Figure 6. The study design shown in figure 1 can be modified to incorporate representation, randomization, and replication in a completely randomized design (A) or in a randomized complete block design (B) to compare seedling responses to applications of Product A and Product B, thereby eliminating excess variation and confounding. Additionally, a control treatment has been added to determine if either of the treatments is better or worse than the existing method.

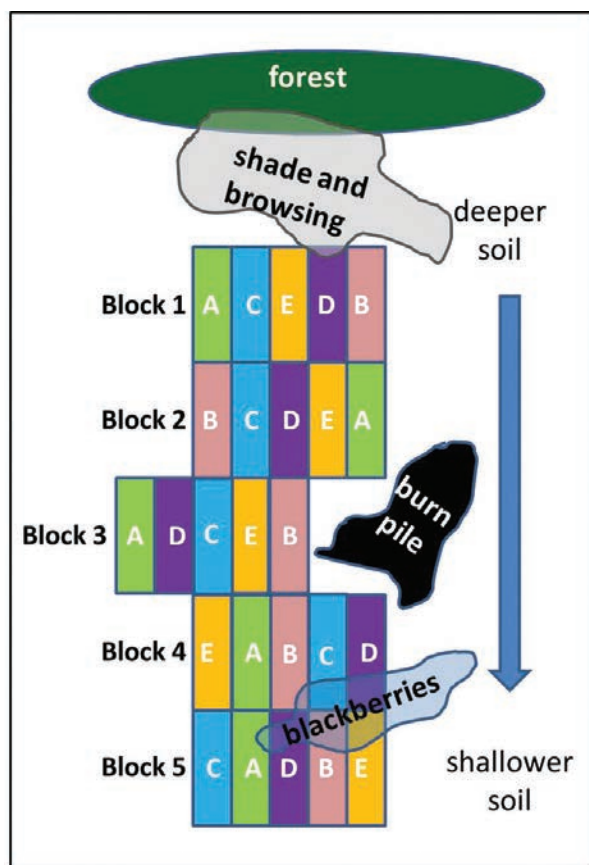

Figure 7. The study shown in figure 2 can be redesigned so that any field performance differences due to nursery of origin (A, B, C, D, and E) can be isolated from variation in site conditions. A randomized complete block design positioned away from known sources of variation or damage along with some vegetation control can improve the quality of the data generated. Note that the revised study design requires the same amount of space and seedlings as the original design.

It's important to note that Cowboy Joe's revised study design requires the same amount of space and seedlings as his original design. There is a misconception that proper study design is costly and time consuming, but this is usually not true. The reality is that poorly designed studies can waste 100% of the time and resources invested, and can lead to additional unnecessary costs if management decisions are predicated on flawed data.

Elements of a Study Plan

Any study should start with a study plan. This document should read like a recipe that anyone can follow from start to finish. The plan needs to be clear, concise, and specific. It does not have to be lengthy but it should contain sufficient detail so the purpose and methods are clearly understood. This is the time to think ahead and plan all aspects of the study. Important elements of a study plan are described in the following sections.

Define the problem and state the objectives

The first step is to describe the issue at hand and the purpose of the study. If the problem cannot be defined, it will be difficult to solve. A

paragraph or two about the problem (history, symptoms, magnitude, consequences, etc.) and the proposed solution will provide the necessary background and justification for the study. From there, the study objective statement can be formed. For example, "The objective of this study is to determine the effect of three fertilizer rates (0, 15, and 30 g [0.0, 0.5, and 1.0 oz]) on first- and second-season growth and survival of Douglas-fir plug+1 seedlings outplanted on a coastal site."

Describe the experimental material and study site

The material selected must be representative of the population in question. For example, "Plug+1 Douglas-fir seedlings (seed lot 123-456, seed zone 071), sown in 2014 at the WeGrow Nursery (Trees, OR), and grown under standard nursery procedures will be used for this study." Likewise, the site should be representative of the environment associated with the problem and objectives. For example, "Seedlings will be outplanted to a site 5 miles NW of Research City, OR at an elevation of 1300 feet. The site was harvested in 2011 and site prepped in 2012."

Describe the treatments

Treatments included in the study should be specific to the problem and objectives. Details about each treatment need to be given. For example, "Four fertilizer treatments will be included in the study: a) unfertilized control, b) 10-25-4 (N-P-K), c) 17-17-17, and d) 15-9-12. Fertilizers are controlled-release (16-month rate) and manufactured by NPK Company (Nutrientville, CA). Fertilizers will be applied once at the time of outplanting, at a rate of 12 g (0.42 oz) per seedling."

Define the experimental design

It is best to use the simplest design that will yield data that can be used to meet the study objectives. Randomization and replication must be outlined. For example, "Seedlings will be outplanted in a completely randomized block design. There will be 6 blocks, each consisting of four treatment plots of 25 seedlings each, for a total of 600 seedlings in the study."

Describe the installation

A good description of study installation specifies dates, labor, equipment, supplies, and any other details associated with establishing the study site. For example, "The study will be planted in February 2014. Color-coded pin flags will mark each planting spot and each seedling will be tagged with block and treatment. Four planters will be needed to install the study and will be monitored for quality. A detailed map of block and plot layout on the site will be prepared."

List the desired data and how it will be collected

It's important to describe the data to be collected on the study including the procedures, timeline, and tools. For example, "Within one week of planting, all seedlings will be measured for initial height and stem diameter. Foliar samples will be collected in July 2014 from a branch in the upper half of 3 randomly selected seedlings in each treatment plot and analyzed for concentrations of N, P, K, Mg, and B. Nutrient analyses will be conducted at Ion Lab, Ltd. (Bunson, ID). At the end of each growing season from 2014 to 2017, all seedlings will be measured for height (groundline to base of terminal bud), stem diameter (1 cm [0.4 in] above groundline), and survival."

Describe how the data will be analyzed

The sources of variation and method of analysis should be determined ahead of time to ensure that the experimental procedures will generate the answers sought. See the Data Analysis section of this paper below for details.

Describe study maintenance and duration

It is important to consider all resources and tasks necessary for the entire study duration. Include necessary annual activities other than data collection. For example, “Competing vegetation will be controlled with herbicide for the first 3 seasons after planting. Plastic mesh tubing and seedling tags will be checked on each measurement date and moved as needed to avoid damage and growth restriction.”

List the expected outcomes

Explain how the study results will be used to address the objective, make management decisions, and determine future research needs. For example, “Results of this study will be used to determine which ponderosa pine stocktype(s) have the greatest growth potential on specific sites in SW Washington. A report of this study will be presented at the 2016 Company Board meeting and an article will be prepared and submitted to *Tree Planters’ Notes* for publication.”

Conducting the Study

A good study design and a detailed study plan can be rendered meaningless if a study is not set up or measured carefully. Use the study plan to guide every step of the study; if anything must be changed, record it in detail. It is important to avoid introducing bias, confounding, or excess variation during study installation or measurement.

Study Installation

Once a study site is selected, the plots should be laid out ahead of time. For an outplanting study, all seedlings should be handled and planted very carefully using experienced planters. As much as possible, the study site should be protected from outside influences that can create more variation and mask potential treatment responses. If browse is anticipated, then the site should be fenced or seedlings protected with mesh tubing. If adjacent treatments have the potential to influence each other, minimize this by installing border rows or buffer strips between treatment plots.

Following is an example of confounding inadvertently created during a study installation: A study plan was developed to compare seedling responses to two different fertilizer treatments and an untreated control using a CRD. The relatively uniform site was laid out ahead of time in a random arrangement of 100 white, blue, and yellow pin flags. In an effort to simplify the planting process, one planter was given a bag of seedlings and a bucket of one fertilizer type to plant at each of the blue pin flags, another planter was given a bag of seedlings and a bucket of the other fertilizer type to plant at each of the yellow pin flags, and the third planter was given a bag of seedlings and no fertilizer to plant at each of the white pin flags. This seemed like a good idea until the forester measured initial height and stem diameter one week later and discovered that seedlings in one of the treatments had a shorter average height than the other two treatments. Since all of the seedlings were from the same seedlot and nursery, and since the sample size was sufficient, this result was unlikely at the onset of the study because treatments could not yet have an influence on seedling size. It turned out that one of the planters tended to plant deeper than the other two planters

resulting in shorter measured heights. To prevent this confounding, the planting could have been done with a single planter or by having each planter plant one-third of the seedlings within each treatment.

Data Collection

As with all other aspects of planning and conducting the study, taking measurements must be done carefully to ensure accuracy and ease of interpretation. It’s important to be consistent when taking measurements (tool used, time of year, and so on). It’s best to measure under ideal conditions if possible; avoid worker fatigue or severe weather conditions to help ensure data quality. Do not introduce any confounding or bias during measurement (some examples: one person measures all of one treatment, or; some treatments are measured earlier than others, or; stem diameter is measured higher up on the stem of trees growing in prickly vegetation).

Initial tree size (or other characteristics of interest) should be measured as soon as possible after the study is installed. This initial data is the benchmark for calculating subsequent changes during the study. Be careful not to damage trees during measurement; broken tops from handling or girdled stems from calipers will result in negative effects on those trees that are not due to the treatment.

If possible, enter data into a spreadsheet on a handheld field device as it is collected. If a handheld device is not available, then carefully enter the data into a computer as soon as possible after it is collected. All data for a single study needs to be in the same spreadsheet so it can be easily analyzed (table 1). Too often, people make multiple spreadsheets for different treatments, different measurements, different dates, and so on. But, data in multiple spreadsheets cannot be imported into statistical software programs and can be unnecessarily confusing.

In addition to measurements on the study subjects, it is valuable to record anything else that may have an influence on the study such as weather events, unusual observations, annual precipitation, etc. It is also recommended to take numerous photos during the study setup and on each measurement date.

Data Analyses

A well-designed study that has been carefully conducted will generate quality data for analyses. Most data for simple field studies as described in this paper are analyzed using Analysis of Variance (ANOVA). Nonetheless, many field and nursery personnel do not have the time or inclination to learn statistical methods nor do they have access to statistical software. Consequently, data sets can sometimes languish or only be analyzed using simple calculations in a spreadsheet. When developing the study plan, it is wise to partner with another person within the agency or company who has a statistical background, with someone outside the company or agency who has access to statistical experience and resources and would like to collaborate on the study, or with someone in academics (professor, student, or extension agent) who can assist with data analyses.

Study Longevity

Accessibility to the site should be available for the duration of the study. A detailed map of the study layout including GPS coordinates, roads, and other major site features is indispensable (figure 5). Also, lasting identification of plot boundaries and individual trees is essential. Pin flags are useful for study layout but can fade over time or be hard to locate once vegetation establishes on the site. Labeled wooden or metal fence stakes can be used to mark the corners or centers of plots. Aluminum tags are useful for tagging individual trees with block, plot, and tree numbers (if placed on the main stem, these tags will need to be moved after a year or two to prevent girdling).

Table 1. A spreadsheet of all data in the study is useful to calculate averages, growth, and ratios and can be imported into software programs to determine if there are statistical differences among treatments. This sample spreadsheet shows data for two plots from a study with two treatment factors (fertilizer x stocktype). The spreadsheet includes the identifying information for each tree (block, fertilizer, stocktype, and tree #) and the height, diameter, and survival data measured just after planting (2/2012) and on two subsequent dates (9/2012, and 9/2013) along with comments ("comm") for unusual observations (chlor= cholortic; mt = multi-top; dt= dead top). The full data set continues in subsequent rows for all trees in all treatment plots from all blocks.

block	fert	stock type	tree #	ht212 (cm)	dia212 (cm)	comm 212	ht912 (cm)	dia912 (cm)	surv 912	comm 912	ht913 (cm)	dia913 (cm)	comm 913	surv 912
1	con	P1	1	64	9	.	76	11	1	.	107	18	.	1
1	con	P1	2	48	12	.	63	15	1	.	111	29	.	1
1	con	P1	3	56	10	.	66	12	1	.	87	16	.	1
1	con	P1	4	37	7	.	46	7	1	.	70	15	.	1
1	con	P1	5	52	8	.	62	10	1	.	75	17	.	1
1	con	P1	6	57	6	.	.	.	0	dead	.	.	dead	0
1	con	P1	7	51	8	.	59	9	1	.	71	14	.	1
1	con	P1	8	58	9	.	68	9	1	.	82	15	.	1
1	con	P1	9	57	9	.	62	10	1	browse	88	19	.	1
1	con	P1	10	46	7	.	55	7	1	.	67	12	.	1
1	con	P1	11	58	9	.	63	10	1	.	49	18	dt	1
1	con	P1	12	68	11	.	71	12	1	.	83	15	.	1
1	con	P1	13	40	7	.	.	.	0	dead	.	.	dead	0
1	con	P1	14	53	10	.	.	.	0	dead	.	.	dead	0
1	con	P1	15	58	9	.	64	9	1	.	.	.	dead	0
1	con	P1	16	43	6	.	44	7	1	.	43	8	dt	1
1	F1	s15	1	31	5	.	50	10	1	.	66	13	.	1
1	F1	s15	2	23	4	.	43	9	1	.	76	15	.	1
1	F1	s15	3	38	6	.	65	10	1	.	120	21	.	1
1	F1	s15	4	33	5	.	57	10	1	.	93	20	.	1
1	F1	s15	5	33	7	.	52	13	1	.	86	20	.	1
1	F1	s15	6	40	5	.	62	10	1	.	89	17	.	1
1	F1	s15	7	43	7	.	59	10	1	.	73	16	.	1
1	F1	s15	8	43	6	.	75	11	1	.	133	44	.	1
1	F1	s15	9	33	7	.	38	11	1	brown	61	17	.	1
1	F1	s15	10	37	7	.	57	10	1	.	86	17	.	1
1	F1	s15	11	48	7	.	65	11	1	.	80	17	.	1
1	F1	s15	12	35	6	.	37	8	1	chlor	59	14	.	1
1	F1	s15	13	40	5	.	47	10	1	.	88	23	.	1
1	F1	s15	14	37	5	mt	48	6	1	.	54	11	browse	1
1	F1	s15	15	42	6	.	68	10	1	.	74	13	.	1
1	F1	s15	16	41	5	.	53	7	1	.	78	14	.	1
and so on														

References and Additional Reading

- Binkley D. 2008. Three key points in the design of forest experiments. *Forest Ecology and Management* 255: 2022-2023.
- Clewe, AG. 2001. *Practical statistics and experimental design for plant and crop science*. . John Wiley & Sons, Inc. New York, NY. 346 p.
- Cochran WG, Cox GM. 1992. *Experimental Designs*, 2nd edition. John Wiley & Sons, Inc. New York, NY. 640 p.
- Dictionary.com. 2013a. “bias,” in *Dictionary.com Unabridged*. Random House, Inc. <http://dictionary.reference.com/browse/bias>. (February 2014).
- Dictionary.com. 2013b. “confound,” in *Dictionary.com Unabridged*. Random House, Inc. <http://dictionary.reference.com/browse/confound>. (February 2014).
- Fowler N. 1990. The 10 most common statistical errors. *Bulletin of the Ecological Society of America*. 71: 161-164.
- Pinto JR, Dumroese RK, Davis AS, Landis TD. 2011. Conducting seedling stocktype trials: A new approach to an old question. *Journal of Forestry*. 109: 293-299.
- Rose R. 2000. Cowboy science. *Western Forester*. March/April 2000: 2-3.
- Stafford SG. 1985. A statistics primer for foresters. *Journal of Forestry*. 83: 148-157.
- Steel EA, Kennedy MC, Cunningham PG, Stanovick JS. 2013. Applied statistics in ecology: common pitfalls and simple solutions. *Ecosphere* 4(9): Article 115.

Western Forest and Conservation Nursery Association Meeting, Olympia, Washington



Bob Buzzo and his staff gave a tour of the Lawyer Nursery (Olympia, WA) for participants in the Western Forest and Conservation Nursery meeting. Photos by Diane L. Haase

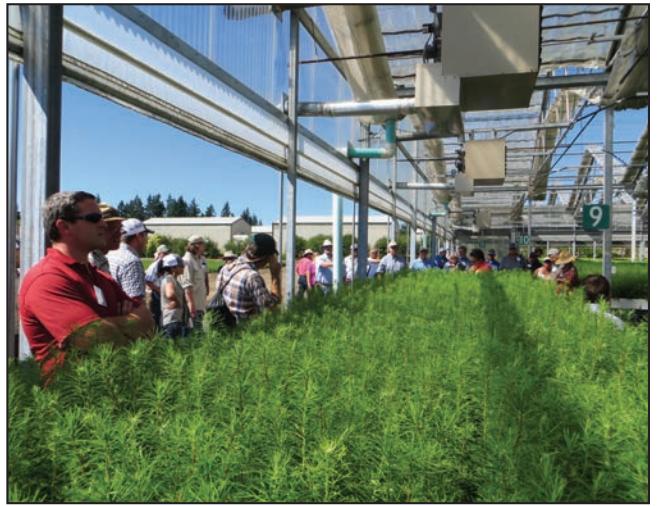

John Trobaugh and his staff gave a tour of the Webster Nursery (Olympia, WA) for participants in the Western Forest and Conservation Nursery meeting. Photos by Diane L. Haase

The U.S. Department of Agriculture (USDA) prohibits discrimination in all of its programs and activities on the basis of race, color, national origin, age, disability, and where applicable, sex (including gender identity and expression), marital status, familial status, parental status, religion, sexual orientation, political beliefs, genetic information, reprisal, or because all or part of an individual's income is derived from any public assistance program. (Not all prohibited bases apply to all programs.) Persons with disabilities who require alternative means for communication of program information (Braille, large print, audiotape, etc.) should contact USDA's TARGET Center at (202) 720-2600 (voice and TDD).

To file a complaint of discrimination, write to: USDA, Assistant Secretary for Civil Rights, Office of the Assistant Secretary for Civil Rights, 1400 Independence Avenue, S.W., Stop 9410, Washington, DC 20250-9410.

Or call toll-free at (866) 632-9992 (English) or (800) 877-8339 (TDD) or (866) 377-8642 (English Federal-relay) or (800) 845-6136 (Spanish Federal-relay). USDA is an equal opportunity provider and employer.

Federal Recycling Program  Printed on Recycled Paper



To learn more about RMRS publications or search our online titles:

www.fs.fed.us/rm/publications

www.treesearch.fs.fed.us