



United States
Department of
Agriculture

Forest Service

**Rocky Mountain
Forest and Range
Experiment Station**

Fort Collins,
Colorado 80526

General Technical
Report RM-182



Improving Southwestern Riparian Areas Through Watershed Management

Leonard F. DeBano and Larry J. Schmidt



PREFACE

Riparian areas in the Southwest contain important plant ecosystems in two widely different environments—along small, higher elevation first- and second-order streams, and along large rivers, some of which pass through hot desert environments. These arid environments make the sustenance of the riparian plant communities in these areas extremely tenuous. This paper describes opportunities for better managing existing southwestern riparian areas, and creating hydrologic regimes more favorable for rehabilitating existing or creating new riparian ecosystems. Also, it contains information on the consumptive use of water necessary for supporting riparian ecosystems in these environments. It is intended to serve as a state-of-the-art report on riparian hydrology, and provide general guidelines for improving hydrologic relationships in naturally occurring and man-enhanced riparian areas throughout the Southwest.

Small upland streams support riparian areas that are intimately interrelated with the surrounding watershed. As a result, they reflect both the biotic and abiotic conditions of the watershed in which they exist. The relationship between watershed and riparian areas depends on a balance between “watershed condition” and “riparian health.” This concept is used as the basis for discussing management and rehabilitation of these areas. Management opportunities for rehabilitating these upland riparian areas generally involve improving watershed condition, modifying plant cover, installing small channel structures or gully plugs, or using a combination of all these rehabilitation techniques. Implementing these practices can alter both the amount and duration of streamflow. A promising technique for increasing both amount and duration of streamflow through riparian areas in Arizona chaparral involves upslope vegetation manipulations where deep-rooted shrubs are replaced with shallower rooted grasses requiring less water. Riparian enhancement in response to cover manipulation is not as promising in pinyon-juniper, ponderosa pine, and mixed conifer forests. Before implementing different watershed treatments, land managers need to be continually aware of the strong relationship between watershed condition and riparian health so they are better able to assess any negative and positive treatment effects. In nearly all cases this requires an interdisciplinary approach to management, covering abiotic as well as biotic factors operating within a watershed.

Extensive riparian areas in the Southwest can develop along larger rivers in response to large dams constructed for flood control or water storage because they stabilize erodible channels and extend streamflow duration. Sediment deposited in the reservoirs above these large structures store and release water slowly over time, sometimes producing perennial streamflow. Deposited sediments also provide a nutrient-rich substrate favoring plant establishment and growth. Case studies are presented where large and intermediate channel structures have enhanced riparian establishment.

Although instream structures can create a more favorable environment for riparian ecosystems, they may also change the channel dynamics of both up- and downstream channel reaches. Also, the vegetation invading these sites is usually dominated by saltcedar, which is of lower value for wildlife habitat than native riparian plant species that formerly occupied these sites. This mix of advantages and disadvantages must be considered in any management decision or plan.

Several naturally occurring processes, operating at different scales, also provide the moving forces for floodplain and associated riparian area development. These include changes in channel slope resulting from landslides, tributary alluvial fans, log step formation, beaver dam construction, and geologic processes such as cienega formation. Effective management of these naturally occurring riparian areas requires understanding the hydrologic and hydraulic processes responsible for their formation.

Improving Southwestern Riparian Areas Through Watershed Management

Leonard F. DeBano, Principal Soil Scientist
Rocky Mountain Forest and Range Experiment Station¹

and

Larry J. Schmidt, Hydrologist
National Forest System

Abstract

This paper reviews opportunities and watershed restoration techniques available for rehabilitating and enhancing riparian ecosystems in southwest environments. As such, it is intended to serve as a state-of-the-art report on riparian hydrology and improvement in both naturally occurring and man-made riparian areas throughout the Southwest.

¹Headquarters is in Fort Collins, in cooperation with Colorado State University. DeBano is stationed in Tempe, in cooperation with Arizona State University.

CONTENTS

	Page
INTRODUCTION	1
RIPARIAN TERMINOLOGY	1
CONCEPT OF RIPARIAN HEALTH AND WATERSHED CONDITION	2
Concepts and Definitions	2
Relationships Between Watershed Condition and Riparian Health	2
IMPROVING RIPARIAN HEALTH AND WATERSHED CONDITION .	5
Restoring Watershed/Riparian Equilibrium	5
Improving Watershed Condition	6
The Role of Channel Treatments in Watershed and Riparian Rehabilitation	6
Case Studies	7
Effect on Channel Dynamics	9
Maintenance and Upkeep	9
Guidelines for Improving Watershed Condition and Riparian Health .	9
Synopsis	11
WATER AUGMENTATION AND RIPARIAN ENHANCEMENT	12
Cover Manipulation and Water Augmentation	12
Case Study	12
Synopsis	13
THE ROLE OF IN-STREAM CHANNEL STRUCTURES IN RIPARIAN HYDROLOGY	14
Naturally Occurring In-Stream Channel Structures	14
Cienegas	14
Streamside Vegetation and Organic Debris Accumulation	15
Beaver Dams	16
Synopsis	16
Man-Made In-Channel Structures	16
Large Dams	17
Intermediate-Sized In-Stream Structures	19
Bank Protection Structures	20
Synopsis	21
WATER USE BY RIPARIAN ECOSYSTEMS	21
Lower Elevation Riparian Ecosystems	21
Upland Riparian Zone Water Use	22
Synopsis	22
RESEARCH NEEDS	22
SUMMARY AND CONCLUSIONS	23
LITERATURE CITED	24
APPENDIX	32

Improving Southwestern Riparian Areas Through Watershed Management

Leonard F. DeBano and Larry J. Schmidt

INTRODUCTION

Riparian areas are ecologically important habitats throughout the Southwest. They are sensitive to disturbance and degradation, but at the same time are resilient and can recover rapidly when managed properly. Although much has been written on vegetation structure and classification (Johnson and Lowe 1985, Swanson et al. 1988, Szaro 1989), water consumption (Horton 1973), grazing effects (Platts and Raleigh 1984, Skovlin 1984), and wildlife (Johnson et al. 1985, Thomas et al. 1979) in riparian areas, only recently have publications documented how different watershed practices have rehabilitated existing, or enhanced potential, riparian areas throughout the Southwest (DeBano and Hanson 1989, DeBano and Heede 1987, DeBano et al. 1984, Heede and DeBano 1984, Szaro and DeBano 1985).

Riparian areas can be improved by either riparian enhancement or rehabilitation. Riparian enhancement is used in the context defined by Platts and Rinne (1985): "returning the riparian/stream habitat to a more productive condition by natural or artificial means." Enhancement includes those activities that change streamflow regimes so as to encourage the establishment of new riparian areas. Riparian rehabilitation, on the other hand, is linked to describing those situations where deteriorated riparian areas are improved, but may not necessarily be restored to pristine conditions. Likewise, watershed rehabilitation is used rather than watershed restoration because the former implies only that a watershed is being improved, not necessarily restored to a pristine or former condition.

When discussing the effect of watershed practices on riparian improvement, it is useful to distinguish between small riparian stringers along small streams passing through higher elevation rangelands, brush fields, and forest types as contrasted to the extensive riparian ecosystems along large rivers passing through lower elevation desert environments.

Our current understanding of riparian area hydrology in the Southwest is based mainly on past water augmentation research conducted mainly in the 1950's and 1960's in both the upland and lower elevation environments (Hibbert et al. 1974, Horton 1973). In both environments, a major emphasis of past research on water augmentation emphasized phreatophyte control (Horton 1973). Because of this past emphasis, current watershed managers are often incorrectly viewed as being mainly interested in eradicating phreatophyte vegetation in riparian areas to increase water production. Modern watershed managers recognize riparian areas contain important plant ecosystems that interrelate the contributing watershed with the aquatic ecosystem.

Healthy riparian areas stabilize stream channels, provide storage for sediment, serve as nutrient sinks for surrounding watersheds, and improve the quality of water leaving the watershed. They also provide water temperature control through shading, reduce flood peaks, and serve as key recharge points for renewing ground water supplies (Groeneveld and Griepentrog 1985, McGlothlin et al. 1988, Zauderer 1987). Although many past watershed management action programs have been implemented primarily for watershed improvement of upland areas and for water storage and flood control in downstream environments, they provided an added benefit of rehabilitating or enhancing riparian areas under a wide range of climatic conditions.

The overall objectives of this document are to provide (1) a state-of-the-art report on riparian hydrology in the Southwest, and (2) general guidelines for improving hydrologic relationships in naturally occurring and man-induced riparian areas throughout the arid Southwest. As a result, the document focuses on improving riparian areas in harsh arid environments where intermittent and ephemeral streamflow predominate. This document is not intended to be a review of the direct effect of grazing on riparian areas, nor will it deal with the management of riparian areas for fishery habitat. Excellent state-of-the-art papers are available elsewhere on the impacts of grazing on riparian habitat (Skovlin 1984) and management for stream habitat (Platts and Raleigh 1984, Platts and Rinne 1985, Platts et al. 1987, Rinne 1988). Therefore, the more specific objectives of this paper include: (1) reviewing riparian terminology, (2) presenting a conceptual relationship between watershed condition and riparian health in arid upland areas, (3) presenting guidelines for improving watershed condition and riparian health, (4) discussing the role of instream structures in riparian rehabilitation, (5) using several case studies to illustrate a wide range of watershed practices that have enhanced establishment of riparian ecosystems, (6) analyzing the effect of different watershed practices on stream and channel dynamics in riparian areas, (7) reviewing past research and estimates of water use by southwestern riparian ecosystems, and (8) discussing further hydrologic research needed in riparian areas.

RIPARIAN TERMINOLOGY

Numerous terms have been coined in riparian literature. This wide array of terminology has often led to confusing, and in some cases conflicting, use of similar terms for the same entity being described. Definitions and terminology have been reviewed by several authors (Anderson 1987, Johnson and Carothers 1982, Johnson

and Lowe 1985, Johnson et al. 1984, Lowe et al. 1986, Platts et al. 1987, Swanson et al. 1982) and are summarized in appendix A.

Because of the wide disparity in commonly used riparian terms, the specific definitions used by the U.S. Forest Service will be used whenever possible throughout this document. The U.S. Forest Service is currently using the following definitions in its manual (USDA Forest Service 1986).

Riparian areas.—Geographically delineable areas with distinctive resource values and characteristics that are comprised of the aquatic and riparian ecosystems.

Riparian ecosystem.—A transition between the aquatic ecosystem and the adjacent terrestrial ecosystem; identified by soil characteristics or distinctive vegetation communities that require free or unbound water.

Aquatic ecosystems.—The stream channel, lake or estuary bed, water, biotic communities, and the habitat features that occur therein.

It is important to note, according to these definitions, that the term "riparian area" encompasses both the aquatic and riparian ecosystem. This definition is also used without being restricted to conditions where hydric soils or perennial surface flow are present. Hydric soils may not be evident in some areas because of extensive destruction in former riparian areas. Likewise, the appearance of dry channels does not necessarily indicate that a perennial water supply is not within the rooting zone of riparian plants. Additional terms will be defined as used throughout the document.

CONCEPT OF RIPARIAN HEALTH AND WATERSHED CONDITION

The objective of this section is to develop a conceptual model relating *riparian health* and *watershed condition* for upland watersheds. The upland watersheds are those drained by first- and second-order streams. Although many of the relationships required for such a model are available in the literature, they have not previously been synthesized into a body of information that can serve as guidelines for resource managers.

Concepts and Definitions

The term *watershed condition* describes the state of a watershed. It effectively integrates such resource factors as vegetation cover, flow regime, sediment and nutrient output, site productivity (Hanes et al. 1986, Solomon et al. 1982), and the associated riparian areas. Although dense and sparse cover are sometimes used synonymously with good and poor watershed condition, other attributes are included in this distinction (table 1). The condition of watersheds is important because it also influences the quality, abundance, and stability of downstream resources and habitat by controlling production of sediment and nutrients, influencing streamflow, and modifying the distribution of chemicals throughout the environment.

Riparian health, as an important component of watershed condition, refers to the stage of vegetative, geomorphic, and hydrologic development, along with the degree of structural integrity exhibited by a riparian area. This concept also encompasses the complex relationships existing between riparian areas and the surrounding watersheds (DeBano and Schmidt 1989). Considered over long time spans, riparian areas reflect both biotic and abiotic conditions of the watershed in which they reside, although they may not necessarily be synchronized at any given point in time.

Relationships Between Watershed Condition and Riparian Health

A healthy riparian area is in dynamic equilibrium with the stream. In this condition, the riparian vegetation remains vigorous and does not encroach into the channel, nor does streamflow expand meander belts through the riparian area, or impact it by aggradation or degradation of the channel bed. The equilibrium between channel aggradation and degradation in riparian areas can be illustrated by a conceptual model (Lane 1955) for describing relationships between sediment production and magnitude of streamflow, which was later expanded by Heede (1980) for stream dynamics. This model depicts

Table 1.—Attributes of good and poor watershed condition.

Good level	Poor level
A Vegetation and litter cover capable of absorbing precipitation energy, increasing infiltration, and extending release of flow to channels.	A' Storm energies detach soil, seal soil pores, increase erosion, thereby creating a flashy sediment-laden runoff, resulting in ephemeral flows.
B Minimal drainage density channel network is necessary for conveying runoff from watershed.	B' Expanding drainage density and channels to accommodate increased surface flow.
C Large temporary storage of water in the watershed system.	C' Rapid conveyance of water from watershed with minimal retention of water for later release.

a healthy riparian area as one maintaining a dynamic equilibrium between streamflow forces acting to produce change and vegetative, geomorphic, and structural resistance (fig. 1).

The attributes of healthy and unhealthy riparian areas are given in table 2. When this natural system is in dynamic equilibrium, it maintains a level of stability that permits internal adjustments of variables without producing rapid changes in the system. This resilience, or resistance to rapid change, results from a combination of factors acting together in the riparian area and throughout the watershed in general. Most important of these is vegetation. Flows in excess of channel capacity overflow onto floodplains where vegetation and other debris provide a substantial resistance to flow and act as filters, or traps, for sediment. During these bank overflows, opportunities are available for germination and establishment of certain riparian plant species (Asplund and Gooch 1988, Brady et al. 1985, Szaro 1989).

The balance between watershed health and riparian condition can be defined in terms of four possible combinations of watershed condition and riparian health (fig. 2). The likelihood of the four combinations vary in time and space. In general, however, it is likely that healthy and productive riparian areas reflect a balance between the riparian ecosystem, including the associated channels, and the hydrologic and geomorphic processes operating in tributaries of a watershed that is in good condition. At the other end of the spectrum, it is also very likely that unhealthy riparian areas reflect poor watershed conditions. It is possible, although less likely, to have other combinations of watershed condition and riparian health because of lag periods between changes on the watershed slopes and in the riparian areas. For example, it is possible to have an unhealthy riparian area while the surrounding watershed is in good condition because of concentrated overgrazing in the

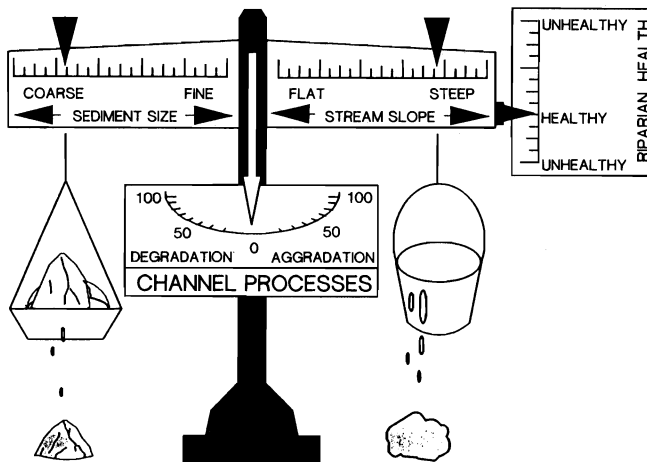

Figure 1.—Healthy riparian areas depend upon a dynamic equilibrium between channel aggradation and degradation processes. The equilibrium illustrated oscillates both in time and space throughout the channel network. The channel network adjusts in form and slope to handle increased storm flows with limited perturbation of channel and associated riparian plant community.

riparian area. Over long enough periods of time, misuse of riparian areas may lead to channel incision and gully development throughout the surrounding watershed. It is least likely to have a healthy riparian area present when the surrounding watershed is in poor condition, although installation of structures and exclusion from grazing may temporarily improve riparian areas on watersheds that are generally in poor condition.

A healthy watershed/riparian system is also resilient. Most of the potential runoff produced by storms immediately infiltrates into the soil (Horton 1937) and thus provides more regulated flow, which is characteristic of runoff generated by a variable source area model (Hewlett and Troendle 1975), except where water is delivered rapidly to the channel by pipeflow. Excess runoff reaching the channel increases flow volume and velocity, and this short-term increase in flow causes an oscillation in the equilibrium between erosion and deposition in the riparian area. While the balance tips back and forth, it is quickly dampened by the channel characteristics and results in no major change in the central tendency toward maintaining a dynamic equilibrium. When the resilience, or elasticity, of the system is not violated, a new dynamic equilibrium condition can be established.

The interrelationship between watershed condition and riparian health is well substantiated by historical documentation. Historical accounts of many riparian areas in the Southwest (Dobyns 1981, Minckley and Rinne 1985) portray them as stable, aggrading stream networks containing substantial amounts of organic debris and supporting large beaver populations. Under these conditions, forested headwater tributaries provided a continuous supply of small and large organic debris that formed log steps in smaller streams (Heede 1972, 1985a, 1985b) and large accumulations of logs and other organic debris along higher order, low-elevation mainstreams (Minckley and Rinne 1985). Naturally occurring floodplain and channel structures, along with living plants, dissipated energy, controlled sediment movement and deposition, and thereby tended to regulate and sustain flow that provided a hydrologic environment sufficiently stable for maintaining and perpetuating healthy riparian ecosystems. The energy dissipation decreased flow velocities in stream channels and on floodplains, which improved percolation of water into subsurface storage. This delaying effect was likely enhanced because many stream channels were above fault-fracture zones that lead to underground aquifers (McGlathlin et al. 1988).

Water stored in these high-elevation aquifers was available and, when slowly released, supported late-season flows in downstream riparian areas. Sufficiently dense vegetation and ground cover were also present throughout the watershed, which allowed precipitation from storm events to infiltrate into the soil. Water passing slowly through the soil mantle sustained a dependable perennial streamflow necessary for maintaining downslope riparian ecosystems.

It is also important to note that under this pristine regime, most storm events infiltrated into the soil; as a result, channel networks were less extensive (Carlston

Table 2.—Important attributes of healthy and unhealthy riparian areas.

Healthy	Unhealthy
A Efficient channel shape with narrow channel that conveys all flows less than that of the mean annual flood (2.33-year recurrence interval) with minimal bank and channel erosion.	A' Inefficient channel shape often braided or shallow and widely fluctuating. Most flows confined in channel. Severe bank and channel erosion and expanding width.
B Stream power < critical power.	B' Stream power > critical power.
C Channels have low hydraulic energy gradient and high sinuosity.	C' Channels have high hydraulic energy gradient and low sinuosity.
D Flows above mean annual flood leading to low energy flow on the floodplain: dissipating energy, filtering sediment, and capturing sediment.	D' Flows above mean annual flood lead to high velocity on the floodplain. Limited energy dissipation. Removal of sediment and nutrients from floodplain.
E Log step and transverse gravel bar formation in confined channels. Infrequent occurrence of knickpoints. Well-developed meanders in nonconfined channel.	E' Channel steps are lacking. Frequent occurrence of knickpoints.
F Channel generally stable with aggrading floodplain.	F' Channel degrading with mild infrequent floodplain deposits. Floodplains undermined and eroded.
G Water table near surface and increased water storage capacity.	G' Deep water table and decreased water storage capacity.
H Abundant vegetation with roots penetrating and stabilizing nearby streambanks.	H' Little vegetation and roots to protect and stabilize streambanks.
I Larger late summer streamflows.	I' Low late summer streamflows.

1963). Generally, swales and slopes were free of incised channels and gullies. Flows also typically carried less sediment. Sustained flow provided a favorable environment for extensive riparian vegetation and supported a beaver population that constructed dams, which further regulated flows. The beaver were likely in dynamic balance with the food supply and predation, and may have expanded the areas supporting riparian vegetation (Parker et al. 1985, Skinner 1986).

Historical misuse of both watershed sideslopes and associated riparian ecosystems throughout the West, in many cases, effectively shifted the balance between watershed condition and riparian health. In many upland areas, widespread overgrazing on rangelands decreased watershed condition by destroying plant cover and decreasing infiltration of water into the soil (Crad-

dock and Pearse 1938, Dortignac and Love 1960, Ellison 1954, Elmore and Beschta 1987, Forsling 1931, Leopold 1946, Rich and Reynolds 1963, Woodward and Craddock 1945). On forested areas, accelerated erosion associated with improper logging practices and road construction during timber harvesting also contributed to unsatisfactory watershed condition. Surface erosion from undisturbed forests was low to nonexistent because enough litter was present on the forest floor to protect the soil surface. Soil permeabilities were normally high (Leaf 1966, Ward and Baker 1984). However, following timber harvesting, surface erosion usually accelerated in response to disruption of soil structure during logging, removal of protective cover, increased raindrop impact and wind movement, reduced infiltration rates resulting from compaction that created overland flow, and the concentration of water by roads, skid trails, and landings (Megahan 1981).

In summary, a common scenario leading to destruction of these upland riparian ecosystems was as follows: Grazing or timber harvesting led to a loss of protective plant cover and soil compaction. When removal was severe, infiltration was reduced and overland flow increased. Excessive overland flow delivered more water to the channels where it exceeded channel capacity and resulted in channel enlargement and downcutting. This produced expanded drainage networks that maintained undesirable flashy runoff and increased available sediment. When roads and trails were developed as part of

		RIPARIAN HEALTH	
		Healthy	Unhealthy
WATERSHED CONDITION	Good	Very likely	Less Likely
	Poor	Least likely	Very likely

Figure 2.—The likelihood of occurrence of different combinations of watershed condition and riparian health.

this use, overland flow was further concentrated and water delivery to the channels increased. Incising channels intercepted and drained existing water tables, many of which were close to the surface and supported healthy riparian ecosystems (fig. 3a). Lowering water tables led to dewatering, alteration and destruction of riparian ecosystems, and an overall reduction in site productivity (Harvey and Watson 1986, Heede 1986, Melton 1965, Schumm et al. 1984) (fig. 3b). Therefore, the resulting attributes of watershed condition and riparian health were quite different (tables 1 and 2). In contrast, on lower elevation mainstems, woodcutting, agricultural development, urbanization, or more subtle impacts of desiccation from stream incision, impoundment, and channelization, along with overpumping of regional groundwater aquifers, were responsible for the widespread destruction of riparian areas (Conrad and Hutchinson 1985, Cooke and Reeves 1976, Minckley and Rinne 1985).

IMPROVING RIPARIAN HEALTH AND WATERSHED CONDITION

Improving the balance between watershed condition and riparian health requires correctly diagnosing the

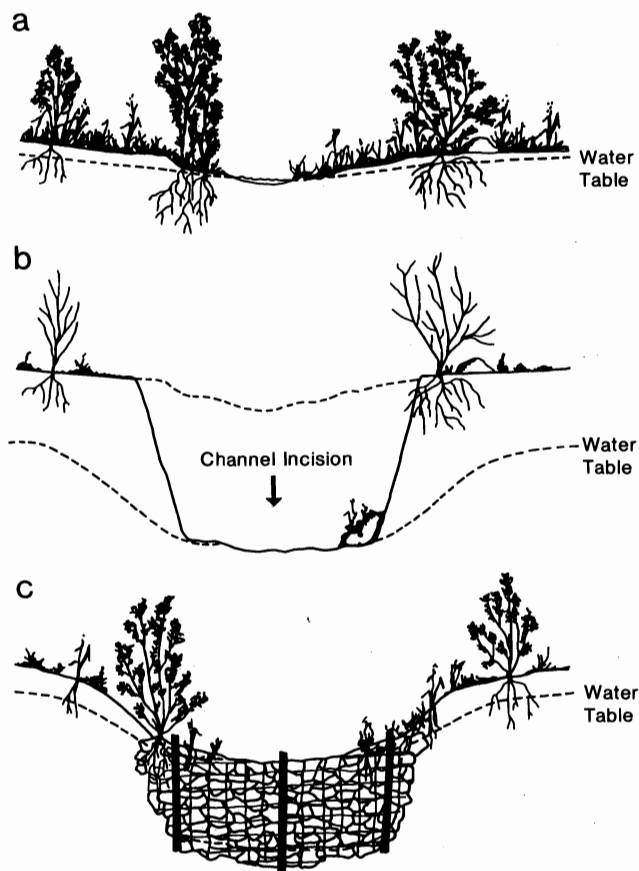

Figure 3.—Water table and riparian vegetation relationships: (a) before channel incision, (b) after channel incision, and (c) following rehabilitation with a channel structure.

causes for unbalance and then implementing appropriate rehabilitation treatment plans. Various levels of treatment intensity may be necessary to rehabilitate riparian areas and/or watersheds to restore a desired balance between the two. General approaches for diagnosis, along with specific guidelines for improving riparian health and watershed condition, are presented below.

Restoring Watershed/Riparian Equilibrium

The balance between watershed condition and riparian health in upland areas is delicate. As a result, it responds readily to both natural processes and human activities. Watershed and land managers have long recognized the need for action programs aimed at rehabilitating misused and deteriorated watersheds (Forsling 1931, Leopold 1946, Lusby 1970, Packer 1953). This awareness led to widespread implementation of watershed rehabilitation projects and programs throughout the western United States (Bailey et al. 1947, DeBano and Hansen 1989, Doty 1971, Hansen and Kisser 1988, Heede 1976, U.S. GAO 1988). The objectives of these projects were primarily to improve plant cover and reduce runoff and erosion by using either revegetation techniques, engineering structures, or both. These treatment measures generally reversed the processes responsible for initially destroying the riparian areas. As a result, these treatments provided a new equilibrium so that the riparian/watershed system could respond to a wider range of storm events and flow fluctuations without producing drastic, or irreversible, changes in the relative balance.

A variety of land treatments and revegetation measures have been applied to deteriorated watersheds to improve hydrologic and hydraulic conditions so existing riparian ecosystems can become stabilized, or new ones created. However, the causes for degradation and stage of channel evolution must be identified before rehabilitation strategies can be developed (DeBano and Hansen 1989, Van Haveren and Jackson 1986). General approaches for providing a more stable riparian/watershed balance are based on two general types of action programs: (1) improving watershed condition on the sideslopes, and (2) stabilizing channels to reduce erosion and downcutting.

These general action programs provide a basis for defining and implementing treatments ranging from simple changes in grazing management, timber harvesting practices, or planting and revegetation activities to more complex measures involving construction of channel structures or mechanical sideslope treatments. However, a careful analysis of cause-and-effect relationships is needed before rehabilitation programs are implemented (DeBano and Hansen 1989, Hansen and Kisser 1988).

Problem identification must also include a careful assessment of both land and channel systems as they relate to current and past land-use practices or catastrophic events such as wildfires. In all cases, the manager must recognize that long periods of time may pass before changes in watershed sideslopes manifest in the channels and associated riparian ecosystem, or vice versa. This is particularly true in the Southwest, where

erosion must be viewed as a discontinuous process that transports sediment from a source (sideslopes) through a channel system with intermittent periods of storage (Wolman 1977).

This episodic transport process is more characteristic of arid and semiarid climates than of humid regions because the prime cause of erosion in the Southwest is the big storm. These big storms move material from various sources, including material stored temporarily in channels, downstream to gaging stations, and other catchments where it can be measured (DeBano 1977). The long lag time between the occurrence of an event on a watershed and sediment delivery downstream has been reported after wildfires in mixed conifer (Rich and Thompson 1974) and chaparral (Heede et al. 1988) vegetation types in Arizona. The impacts of the large events are somewhat tempered if streambank vegetation is healthy because less stream widening and bank erosion occur than if plant density had been reduced by heavy grazing and other land use activities (Platts et al. 1985).

Improving Watershed Condition

A first, and essential, step in restoring the balance between riparian health and watershed condition is to improve watershed condition. Riparian rehabilitation should not be attempted in stream systems where watershed condition is unsatisfactory or in a downward trend (Heede 1977, Van Haveren and Jackson 1986). Rehabilitation treatments range from improvements in grazing management to complex and expensive mechanical treatments such as contour furrows, pitting, and trenches. Often, improved grazing management alone can restore plant cover, but expanded channel networks may continue to erode and transmit unfavorable flows rapidly. This demonstrates the importance of rehabilitating slopes and surfaces (i.e., channel shaping) as well as improving vegetation cover by grazing management or reseeding.

The simplest way of improving watershed condition on rangelands is to provide plants an opportunity for regaining vigor and establishing a denser ground cover. Increasing plant cover allows more water to infiltrate the soil mantle where it slowly moves downslope through the soil before it reappears as channel flow. Proper grazing management is the key to improving plant vigor of rangeland plants.

Where plant cover cannot be improved by grazing management alone, grass seeding and mechanical treatments may be necessary to retain water and aid in vegetation establishment. However, these treatments may require several years of rest from grazing to allow plants to become well established before grazing is resumed. Mechanical treatments of various intensities varying from contour trenches to ripping, discing, and pitting have also been used successfully for improving plant growth and vigor on rangelands. Contour trenching, although a very expensive watershed treatment, has been used to improve high-elevation, deteriorated watersheds throughout the West (Bailey et al. 1947, Copeland 1960).

This treatment, however, was unsuccessful when used on steep chaparral watersheds in southern California as an emergency measure to control erosion following fire because the typical storms exceeded the designed capacity of the trenches (Rice et al. 1965).

Contour trenches not only reduce peak flows (DeByle 1970a, Doty 1971), but also increase soil moisture storage immediately beneath the treatment depressions (Doty 1972, Gifford et al. 1978). Infiltration rates into trenches vary considerably, however, depending upon the soil parent material (DeByle 1970b). Reseeding with different native and introduced perennial grasses provides an effective means of stabilizing trenches and improving water uptake. The most successful seeding responses are usually obtained on terrace bottoms (Hull 1973). Upstream treatments on watersheds may not necessarily lead to perennial streamflow but should reduce surface runoff and improve sideslope moisture conditions, which contribute to improved watershed condition.

Maintaining acceptable watershed condition on forested and chaparral areas requires different techniques from those used for rangelands. They will depend, in part, on the degree of disturbance. Activities associated with timber and fuelwood harvesting are most frequently responsible for degrading watershed condition on forested lands (Rice et al. 1972). Minimizing soil disturbance and compaction during logging, along with proper road design and location, are important considerations during timber harvesting. Although the effect of fuelwood harvesting on watershed condition of pinyon-juniper woodlands is not well understood, potential erosion on these areas seems more closely related to herbaceous plant densities and their spatial distribution on interspace areas (Heede 1988). The effect of tree canopy removal during fuelwood harvesting on erosional processes is currently being evaluated.

Watershed condition of chaparral areas is affected primarily by brush-to-grass conversions or by wild and prescribed fires. Chaparral-to-grass conversions may not only maintain acceptable watershed condition, but can enhance riparian plant establishment (DeBano et al. 1984). However, conversions on slopes exceeding 40% are not recommended because of the increased potential for mass soil movement on sideslopes (Rice et al. 1969). Several emergency postfire treatments, including reseeding with annual and perennial grasses, contour planting of barley, contour trenches, and channel checks, have been evaluated on burned chaparral watersheds in southern California (Rice et al. 1965). These treatments were generally ineffective in reducing erosion following wildfires, however, because of the steep sideslopes and channel gradients (Barro and Conard 1987, Rice et al. 1965).

The Role of Channel Treatments in Watershed and Riparian Rehabilitation

Southwestern riparian ecosystems are particularly sensitive to overuse because they are subjected to a wide variation in annual precipitation (Leopold 1946). Surface

streamflow is not perennial in many of the smaller drainages. These marginal streamflow conditions make watershed and associated riparian ecosystems extremely sensitive to overuse, and rehabilitation of deteriorated areas is often complex and difficult. Exclusion from grazing and revegetation measures alone may not be sufficient to fully restore former riparian areas if extensive gullying has dissected ground water tables and caused a general dewatering of the area. This is particularly true in areas where streamflow is no longer perennial. When incised channels are present, additional supplementary measures may be needed. These may include construction of gully structures in upland watersheds (fig. 3c) (Bailey and Copeland 1961; DeBano and Hansen 1989; Hansen and Kisser 1988; Heede 1976, 1977) or channel modification in riparian areas to restore water tables and create stream types with morphological characteristics more desirable for riparian ecosystems (Rosgen 1985).

There are basically two approaches for rehabilitating incised channels: flow control or grade control (Harvey and Watson 1986). Grade control can be achieved successfully on small upland watersheds by installing small channel structures which prevent upstream migration of nickpoints. Although installation of small channel structures is often costly and complex, they have proven effective for stabilizing the channel environment and providing for the recovery of some riparian areas in the Southwest (Hansen and Kisser 1988, DeBano and Hansen 1989, Heede 1977, Heede and DeBano 1984). A recent review of 22 successfully rehabilitated riparian areas throughout the western United States showed that 11 projects used in-stream structures, bank riprap, or a beaver dam (U.S. GAO 1988). The remainder were rehabilitated primarily by grazing management in riparian areas.

Case Studies

Constructing check dams in channels has converted ephemeral, or intermittent, streamflow to perennial in several case studies throughout the western United States (DeBano and Hansen 1989, Hansen and Kisser 1988, Heede and DeBano 1984, Stabler 1985). Check dams, which are small, porous channel structures, can be used for this purpose. These check dams can be constructed of soil, concrete, rock, wood, sheet metal, or several other materials (Heede 1960, 1976).

The effect of small channel check dams on riparian enhancement is well illustrated by a gully rehabilitation program initiated in 1958 on the 640-acre Alkali Creek Watershed located in the White River National Forest, about 20 miles south of Silt, Colorado (Heede 1977). Vegetation on the watershed is sagebrush-grassland typically found on the western slopes of the Rocky Mountains in Colorado. Gambel oak occupies the upper parts of north-facing slopes, while sagebrush and grass make up valley bottoms, depressions, and south aspects. (Plant species' scientific names, authority, and common names are presented in appendix B.) Annual precipitation averages about 19 inches, of which approximately 40%

occurs as rain between May and September and 60% as snow during the rest of the year. Valley bottom soils are sodic and contain higher percentages of clay, reflecting alternate layers of sandstone and shale in the underlying parent materials (Heede and DeBano 1984).

Grazing, first started on the watershed in the 1870's, was excessive and resulted in destruction of plant cover which led to overland flow, concentrated channel flow, soil piping, and gully formation. Extensive gully systems, with deeper gullies exceeding 50 feet, were present throughout the watershed before rehabilitation treatments were initiated. Before treatment, streamflow was ephemeral, occurring only during snowmelt periods (Heede 1977). The area was fenced in 1958, and grazing was excluded between 1958 and 1966. Active gully treatment was started in 1961 with the objectives of (1) rehabilitating the depleted watershed by vegetative and engineering measures, (2) testing their combined effectiveness on restoration, and (3) developing new treatment approaches where required. The main treatments consisted of constructing 132 check dams, developing vegetation-lined waterways (1,900 feet), and follow-up vegetation management.

The response of the watersheds to gully treatment, revegetation, and exclusion from grazing was dramatic. During the 12 project years, the check dams accumulated 2,556 yd³ of sediment, gully depth was substantially reduced, and erosion rates were reduced to one-fifth of those on gullies not structurally treated (Heede 1977). The hydrologic regime at Alkali Creek was also changed. Before treatment, streamflow occurred only for about 6 weeks during snowmelt periods. Seven years after treatment, flow discharge was perennial at the watershed mouth, but remained ephemeral in headwater areas of the gully network.

In the upper watershed, duration of streamflow was not extended sufficiently to allow riparian plants to become established. However, grass production increased on sediment deposited in the upper structures although the beneficial effects were limited to grass established in the channels (fig. 4). In contrast, streamflow regime in main channels on the watershed was significantly improved so that a riparian plant community became established (fig. 5). The hydrologic regime in the main channels was improved by a rising water table, resulting from the additional storage of water in sediments deposited in channels above the structures and adjacent gully walls. The stored water was released slowly over time as unsaturated flow (Hewlett and Hibbert 1963) and produced perennial, or near perennial, streamflow. This principle has been used successfully worldwide as a means of artificially recharging subsurface water storage during heavy rainfall periods with "trap-dams" (Baurne 1984).

Prolonged streamflow at Alkali Creek allowed sedges and willows to become established, which enlarged into a dense riparian ecosystem by 1981 (fig. 5c). After the channel bottoms had become stabilized, riparian vegetation spread to the toe and lower segments of the gully sideslopes. Sediment deposits above the check dams prevented undercutting and loss of bank toes, and pro-

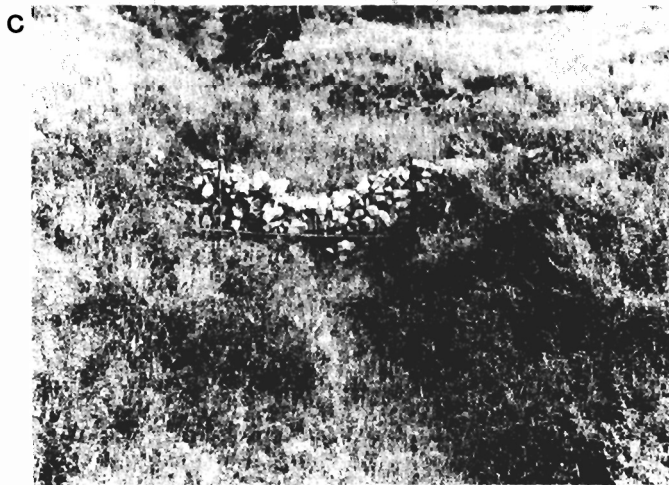
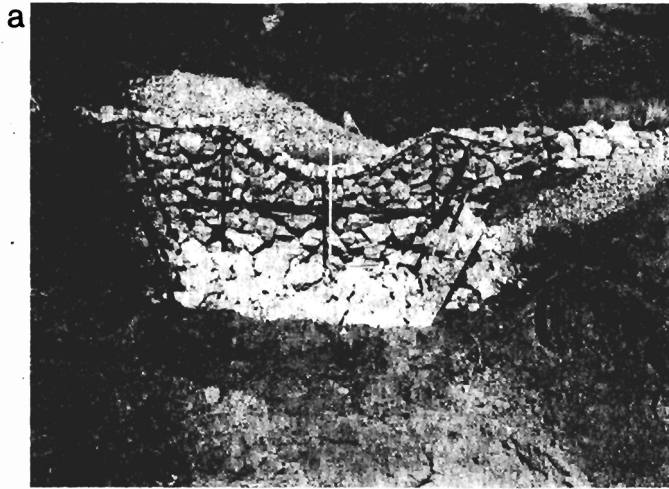

Figure 4.—An upstream view of a rock check dam constructed in an upper watershed channel on Alkali Creek in western Colorado: (a) immediately after construction in 1963, (b) in 1964, and (c) 12 years later in 1975. Notice the establishment of grass on channel banks and bottoms but the absence of riparian plants.

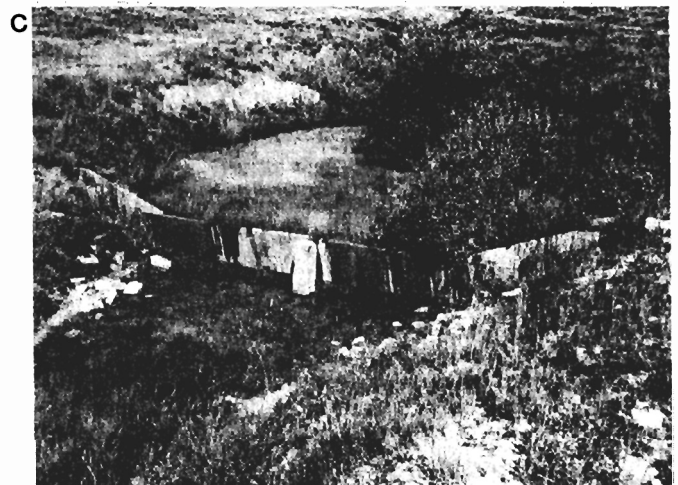
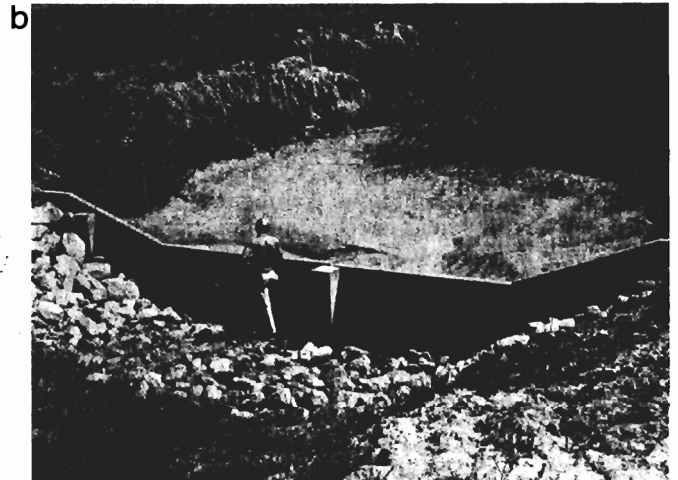
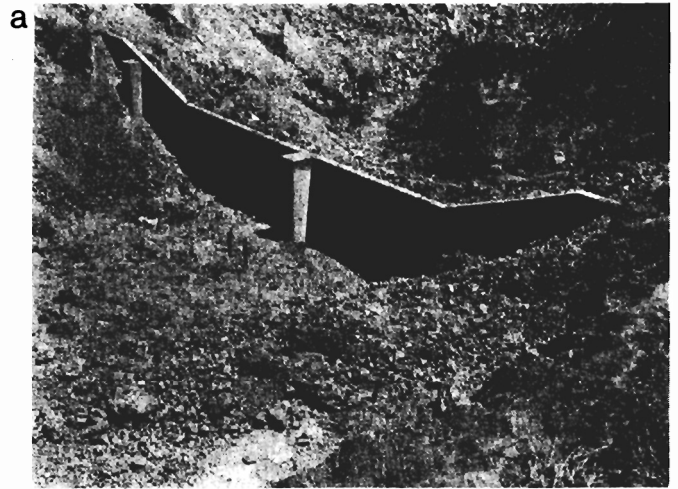

Figure 5.—The appearance of the site occupied by a larger gully control structure at the mouth of Alkali Creek in western Colorado: (a) immediately after treatment in 1963, (b) in 1964, and (c) 12 years later in 1975.

vided the base-level stability necessary for establishing riparian species. The size of gully check networks necessary to store enough water to sustain perennial streamflow depends on local soil and climatic conditions; 132 structures trapped sufficient sediment and water to enhance riparian establishment and development by natural means in the main channels under the prevailing climate at Alkali Creek.

Not only did the hydrologic regime of the watershed improve, but sediment accumulating in channels provided a better medium for plant growth than eroding sideslope material. Much of the eroding sideslope material originated from high-sodium soil lenses (exchangeable sodium percentage greater than 16). It took several years before enough sodium was leached to allow plant growth (Heede 1971). In contrast, sediment deposited in channels had ESP values of less than 1 (Heede and DeBano 1984), which was more favorable for plant growth.

Effect on Channel Dynamics

A well-designed network of channel checks in a watershed can have positive effects on channel dynamics. First, where ample sediment is available, small structures, such as check dams and small earthen gully plugs, withhold only a small portion of the total sediment. Therefore, the sediment load in the streamwater leaving the structure is sufficiently high to prevent it from picking up any large amount of additional sediment. A second important feature of check dams in gullies is that they are often at a designed spacing that transforms turbulent flow into a more tranquil flow with lower energies (DeBano and Heede 1987). The combined result is a stable channel with a static or aggrading base level, which provides a more favorable habitat for riparian ecosystems both upstream and downstream. If riparian vegetation encroaches on check dams and seriously diminishes the flow capacity of spillways, however, then flows may overtop the dam's freeboard or create end cutting of structures. These flows can erode gully banks and, over time, create new gullies around the structure, resulting in destruction of both the dam and associated riparian ecosystem.

Maintenance and Upkeep

An important consideration when developing treatment plans for watershed rehabilitation is to be aware of their effect on upland channel dynamics, and to include provisions for maintaining these structures under different channel equilibrium conditions (DeBano and Heede 1987). This is particularly important when riparian rehabilitation depends upon expensive and complex treatments, such as tributary channel structures. Spillway stability and integrity of structures should be examined regularly and appropriate repairs made immediately to weakened or damaged structures (DeBano and Hansen 1989). Applying good range and forest

management principles in conjunction with channel structures is also a prerequisite for long-term success. This requires applying livestock management methods and stocking levels compatible with watershed and riparian improvement objectives as a whole. These have proven vital to the health and success of newly established riparian ecosystems.

Guidelines for Improving Watershed Condition and Riparian Health

The large body of information on watershed rehabilitation and riparian health described above provides a substantive basis for better understanding the delicate balance between the two, and provides the principles necessary for formulating general management approaches and specific treatment plans for successfully planning riparian area rehabilitation programs. This section summarizes this background information within the framework of the conceptual model in figure 1 and then uses this model as a basis for (1) diagnosing the causes for lack of balance between riparian health and watershed condition; (2) developing objectives for alternative treatments; and (3) specifying treatments necessary for restoring an acceptable balance between watershed condition and riparian health.

Various land uses and misuses affect the balance between watershed condition and riparian health by creating (1) excessive runoff, (2) increased frequency and magnitude of stormflow events, (3) excess discharge, (4) excess stream slope, (5) excess tributary sediment, and (6) excess bank sediment. Substantial permanent changes in watershed condition tip the equilibrium indicated in figure 1 in one direction so no oscillation about the mean occurs. This causes an adjustment in erosion and deposition processes to proceed in the direction indicated by the indicator arrow until a new dynamic equilibrium is established. Once achieved, a new dynamic equilibrium is maintained until new changes exceed the elastic limit of the system, setting the process of adjustment in motion again.

After the factors responsible for disrupting the initial balance between watershed condition and riparian health have been identified, their causes can be used as guiding principles for formulating specific treatment objectives and remedies (table 3). The large array of possible treatment alternatives can be classified into two general types: those used for (1) improving vegetation cover and reducing surface runoff and erosion from sideslopes; and (2) stabilizing channel networks. Four broad alternative courses of action arise from these two general approaches. One alternative is to do nothing. This alternative would usually not be acceptable to managers where riparian/watershed systems are out of balance. The remaining three alternatives require different levels of action programs. A second alternative may involve only managing, or treating, sideslopes. Sideslope treatment would be feasible on those watersheds where naturally occurring control sections (bedrock) are present. Bedrock exposed by channel erosion

Table 3.—Conditions threatening riparian areas and possible remedies for achieving different treatment objectives.

Condition	Cause	Remedy	Treatment objective
Excess runoff	Major flood events on pristine watersheds.	None on watershed. If riparian areas have been damaged, then some structures, bank stabilization, and revegetation may be necessary.	Rehabilitate changes.
	Areas with depleted cover lacking infiltration capacity and resistance to surface runoff.	Improve livestock, game, or fire management. Revegetate and manage for increased vegetation and litter cover.	Increase resistance to surface flow. Greater infiltration capacity. Eliminate sheet runoff.
Increased frequency and magnitude of flow events.	Rilled and gullied slopes resulting from depleted cover or soil compaction.	Reduce drainage density by constructing contour furrows or trenches and manage for increased ground cover. Restoration of vegetation.	Increase retention of storm flow on-site until infiltrated. Eliminate concentrated flow. Regulate runoff through soil mantle. Increase vegetation cover and improve infiltration.
	Roads and travelways that intercept, collect, and concentrate flows.	Intercept flow paths with waterbar and divert flows to areas with greater infiltration capacity. Rip and reseed compacted surfaces where travelways have been abandoned. Improve forest filter by adding log flow obstructions or detention basins. Eliminate traffic.	Shorten slope length. Infiltrate excess flow into forest floor. Restore on-site infiltration of flow and protect soil. Regulate flows through soil mantle.
Excess discharge	Transbasin diversion that produces the effect of greater drainage area and increased flow.	Provide reservoir storage to regulate transferred flows. Avoid inchannel transport of increased flows. Convey increased flows during low-stage seasons.	Maintain flows within the limits of critical stream power.
	Forest harvest effects on water yield that produce greater runoff.	Schedule harvests in time and space over the watershed to maintain increased runoff within the range of channel capacity and critical power. Consider effects of various silviculture techniques on snow retention and water yield. Minimize road density and drainage of lower slopes by roads.	Maintain flows within critical power threshold. Dissipate peak flows through soil mantle.
Excess stream slope	Channelization of riparian areas by roads, trails, and travelways.	Avoid roads, trails, and travelways in riparian areas. Eliminate old travelways and relocate where necessary. Take special precautions and measures to avoid channelized flow where facilities must be in riparian areas.	Maintain slope, channel length, and configuration that support dynamic equilibrium. Avoid actions that concentrate flows, produce higher velocities, or change energy configuration of channels or meadows.
	Historic channelized riparian caused by arroyos, gullies, and travelways.	Reestablish and construct channel configuration and slope that watershed conditions can sustain (Heede 1968a) or use check dams to control grade while channel adjusts to new equilibrium. Where conditions allow, consider introducing beaver.	Develop slope channel length and configuration that supports a new dynamic equilibrium. Correct conditions that generate unfavorable flows.
	Absence of large organic debris to provide steps and energy dissipation in confined mountain channels.	Add logs or rock structures to regain stability. Manage adjacent areas to provide a desired rate of logs to the system.	Reduce stream slope with log steps or other structures. Slow velocities, reduce flood peaks, and increase channel uptake. Stabilize sediments.
Excess tributary sediment	Sheet and rill erosion from denuded areas.	Apply techniques similar to those used for controlling excess runoff.	Reduce exposure to erosion. Eliminate concentrated flow on slopes. Provide vegetation protection.
Excess bank sediment	Incised, confined channels that cut high banks.	Improve watershed condition. Reduce bank heights by installing check dams. Use flow separation techniques to deposit materials to buttress banks and provide a media for riparian vegetation establishment. Use techniques outlined for excess slope.	Reduce availability of sediment. Restore channel equilibrium that can be sustained.

may be currently limiting future downcutting. Under this alternative, if rilling and gulying have not occurred, then sideslope management alone may allow a dense vegetative cover to become established. Where surface rilling and gulying are severe, channel shaping, contour trenching, and revegetation may all be required. Techniques for channel shaping and revegetation are described by Heede (1968, 1975). The primary objective of these treatments is to enhance the natural healing processes, revegetate channel banks, and reduce sediment contributions from bank erosion. It is unlikely riparian ecosystems would be established in response to this treatment alternative because former water tables necessary for riparian rehabilitation have not been restored.

A third, more complex, alternative might involve channel stabilization. This alternative should be attempted only where watersheds are healing naturally as a result of improved management, but require assistance in stabilizing base control sections. The objective of this treatment could be to stabilize or stop downcutting, reduce erosion, and revegetate channel banks. Channel structures, such as check dams, would be constructed to control base levels. Dam spacing and effective spillway heights would be designed not only to store enough sediment to stabilize the channel but to stabilize sideslopes. Successful revegetation of sideslopes depends upon establishing bank stability, which in turn depends on bank height and angle (Grissinger and Bowie 1984), soil shear strength pore pressure relations (Bradford and Piest 1977), and soil particle cementation (Goss 1973). Approaches to gully treatment (Heede 1968, 1976, 1978), computer procedures for gully control (Heede and Mufich 1973, 1974), methods of construction (Heede 1960, 1965, 1966, 1968), and strategies for determining treatment priorities (Heede 1982) are all available in the literature. Water storage and ground water recharge are minimal with this level of treatment and, consequently, enhancement of riparian ecosystems would be limited to a few structures in the main channel of the watershed (DeBano and Heede 1987).

Finally, the fourth, and most comprehensive, treatment alternative involves both channel stabilization and comprehensive watershed rehabilitation (Heede 1977). The objective of this level of treatment would be to stabilize and aggrade channels, and provide adequate channel and ground water storage to encourage the establishment of riparian ecosystems. Channel deposition and ground water recharge would be increased by increasing dam spacing and effective spillway heights. The resulting channel aggradation would provide water storage behind each structure, and improve soil moisture and channel flow. Riparian establishment could occur naturally or be enhanced by planting species adapted to the area.

Any combination of the last three levels of action plans described above may be implemented within a single watershed, but it remains critical to establish treatment objectives first. Although it is possible to enhance or rehabilitate potential riparian areas with these treatments, it is important that continual management and maintenance be included as an integral part of these

rehabilitation plans in order to maintain the effectiveness of the initial treatments.

Synopsis

There are important and sensitive hydrologic relationships between watershed condition and the health and integrity of associated riparian ecosystems throughout the Southwest. However, extensive management activities and natural events in the past drastically altered the balance between watershed condition and riparian health. Vegetation removal and soil compaction substantially increased surface runoff, produced sediment-laden flows, and increased erosive power in the channel system. This led to the degradation and destruction of many riparian areas. A key factor in improving deteriorated riparian areas is understanding the balance that existed between watershed condition and riparian health in near pristine conditions when watershed slopes and riparian channels could dissipate rainfall and concentrated flow energies produced during a wide range of precipitation events.

Land managers are currently implementing a variety of watershed treatments that are, or have the potential for, rehabilitating riparian ecosystems. In some cases, these treatments were initiated for other reasons than improving riparian areas. These treatments increased both duration and/or amount of streamflow. The most obvious practices benefiting riparian areas are upstream treatments aimed at improving watershed condition, lengthening duration of streamflow, reducing peak flows, and stabilizing channels to reduce erosion. Watershed condition may be improved by better livestock management and more judicious road construction during timber harvesting, although sometimes these improved management practices must be supplemented with specific cultural treatments, such as reseeding and tree planting to increase plant cover and vigor. Extremely disturbed watersheds with substantial amounts of rill erosion and channel incision may require strategically located channel structures, bank stabilization, and mechanical treatment of sideslopes to be successfully restored. However, when developing any rehabilitation plan, it must be kept in mind that not all incised channel networks are candidates for channel structures, because (1) some may heal on their own over time; (2) the value of rehabilitation may not justify the cost; or (3) the systems are too dynamic to allow structures to be safely installed.

Successful rehabilitation programs require having a clear picture of the desired balance between riparian health and watershed condition and what caused the current problems. The basic knowledge for improving both watershed and riparian areas is generally available. However, the key to successful rehabilitation lies in wise and timely application of management principles and technology.

Riparian areas are linear in form and thereby serve as key corridors for transporting water and erodible material derived from the surrounding landscape (Brinson et

al. 1981). Because of this, the management techniques described above for enhancing riparian vegetation has some risk; their limitations must be recognized before implementing different treatments. Of particular concern is the effect of these different management strategies on mitigating the erosive power of streamflow characteristics and associated channel dynamics.

WATER AUGMENTATION AND RIPARIAN ENHANCEMENT

Cover Manipulation and Water Augmentation

Vegetation cover manipulation has been studied as a potential management practice for augmenting water yield throughout the Southwest (Ffolliott and Thorud 1974, Hibbert 1979). These practices are based on the premise that replacing plant species having high water use demands with lower water-demanding plants will decrease total evapotranspiration, thereby making more of the annual precipitation available for streamflow.

Increased water delivery to downslope channels in response to upslope vegetation manipulations have been studied for the four major vegetation types in the Southwest—chaparral (Hibbert et al. 1974), pinyon-juniper (Baker 1984), ponderosa pine (Baker 1986), and mixed conifer (Rich and Thompson 1974). Cover manipulations in mixed conifer and ponderosa pine forests mainly involve timber harvesting. Trees are removed from pinyon-juniper woodlands during both fuelwood harvesting and range improvement programs. Brush-to-grass conversions have been proposed as a technique for increasing water yield in Arizona chaparral, although grass forage production is also increased and fire hazard reduced.

Total annual streamflow is increased in all four vegetation types, although the timing and amount of increased water production varies (Hibbert 1979). Duration of streamflow is also significantly increased by brush-to-grass conversions in chaparral (Hibbert et al. 1974). These increases in duration and amount of streamflow have strong implications both for watershed condition (cover on upland slopes is being altered) and riparian health (because of increased amount and duration of streamflow).

Case Study

The effect of brush-to-grass conversions on water augmentation and enhancement of downstream riparian ecosystems was evaluated on the Three-Bar watersheds in central Arizona (DeBano et al. 1984).

The Three Bar experimental watersheds, near Lake Roosevelt in central Arizona, were established for studying the effect of shrub control on water yield in chaparral. Elevation of the Three Bar watersheds varies from 3,280 to 5,120 feet. Mean annual precipitation ranges from 21 to 28 inches. Soil parent material is a coarse granite. Exposure is northerly. The upper slopes of the

watersheds are steep, often exceeding 60% (Hibbert et al. 1974). Dominant shrubs on the Three Bar watersheds are shrub live oak, birchleaf mountainmahogany, sugar sumac, and Emory oak. Streamflow and rain gages were installed in 1956. At that time, streams draining the watersheds were ephemeral, flowing about one-third of the time during the initial 3-year calibration period and yielding, on the average, less than one surface inch of water annually. In June 1959, a wildfire topkilled the shrubs on all watersheds. Shrub cover, which was 60% to 75% before the fire, was reduced to near zero.

Two of the four experimental watersheds at Three Bar were used for assessing the effect of brush control on streamflow and riparian area enhancement—control watershed (D) and a treated watershed (C). Beginning in 1960, watershed C received a series of herbicide treatments aimed at eliminating a dense stand of shrubs. Watershed C was seeded in May 1960 with lovegrasses. By 1969, shrub crown cover on watershed C had been reduced to less than 3%. However, the reseeded lovegrasses formed a dense cover on Watershed C that was intentionally burned in 1971, 1974, and 1978 to keep the invading shrub cover to less than 10%. After the 1959 wildfire, watershed D (88 acres) was allowed to recover naturally as a control. Sprouting shrubs regained about one-third of their prefire crown cover in 3 years and about 90% in 11 years (Hibbert et al. 1982).

Streamflow increased substantially after brush conversion on all treated watersheds (Hibbert 1971). The increases were largest for watershed C, which yielded about 6 surface inches more water per year than expected without treatment. Runoff represented a larger percentage of precipitation in wet years than during dry years for both treated and control watersheds because more water was available for streamflow.

Not only was streamflow volume increased by treatment, but also duration of streamflow during June, July, and August was lengthened dramatically (DeBano et al. 1984). Before the 1959 wildfire, both watersheds C and D experienced long periods without streamflow. From 1957 to 1959, the average period of no streamflow was 76 and 74 days for watershed C and D, respectively. After the wildfire, streamflow from watershed C became perennial and has remained so to date, because herbicide treatments reduced shrub evapotranspiration losses enough to maintain streamflow. In contrast, streamflow from watershed D varied widely. In some years flow was perennial, while in other years there were up to 91 continuous summer days with no streamflow. Streamflow from watershed D was perennial from June through August only when antecedent precipitation exceeded 22 inches. Watershed C maintained perennial flow regardless of the antecedent precipitation, although less occurred during drier years.

Within 5 years after the wildfire, differences in the number of riparian trees and shrubs in the channel below watersheds C and D reflected the difference in streamflow regimes (fig. 6). Before the fire in 1956, riparian species were absent below the gaging station on watershed C (fig. 7a). Immediately after the fire in 1959, the gaging station was devoid of all vegetation. By 1973, large

cottonwood trees had become established (fig. 7b). By 1983, the stream reach immediately below the gaging station supported a dense stand of willows, cottonwoods, and other species (fig. 7c). In contrast, below the control watershed D few riparian plants were present by 1983. Common riparian species below the gaging station at 3-Bar C were Gooding willow, red willow, and Fremont cottonwood. Smaller numbers of Arizona walnut and broom baccharis were also found in the stream channel below watershed C but not below watershed D.

It might be questioned whether enhancing riparian vegetation reduced the increased water yield sought by the original treatments. Previous research established that about 85% of the increased water yield is produced during the dormant season (November-April), which benefits the delivery of water downstream (Hibbert et al. 1982). Thus, it was concluded that establishing narrow stringers of riparian vegetation at the mouth of watershed C would have little impact on downstream water yield increases produced by upslope shrub control.

The chaparral-to-grass conversion treatment on the 3-Bar C watershed had mixed effects on bird populations (Szaro 1981). Although population density, species richness, and diversity of bird populations increased in the riparian area, these indices were lower for the grasslands compared to the original stand of chaparral.

Recent studies on chaparral conversions have shown similar water yield increases can be obtained by chaparral-to-grass conversions in a mosaic pattern where only about 60% of the brush is treated and replaced with grass (Hibbert and Davis 1986). The remaining 40% of the brush can be left in strategic locations to protect steep slopes from erosion, maintain desirable plant species, and provide habitat diversity for wildlife.

Synopsis

Vegetation cover manipulations, particularly brush-to-grass conversion in chaparral, offer a viable technique for both increasing and lengthening streamflow, thereby

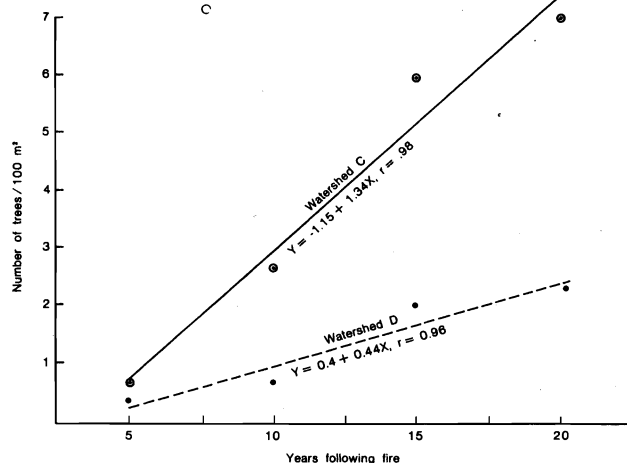

Figure 6.—The number of riparian tree species established below a chaparral watershed treated for shrub control (C) and on a nearby untreated watershed (D) (DeBano et al. 1984).

enhancing the establishment of downstream riparian areas. These conversions, when carefully planned, will probably not produce any long-term change in watershed condition (increase erosion, reduce plant cover, etc.).

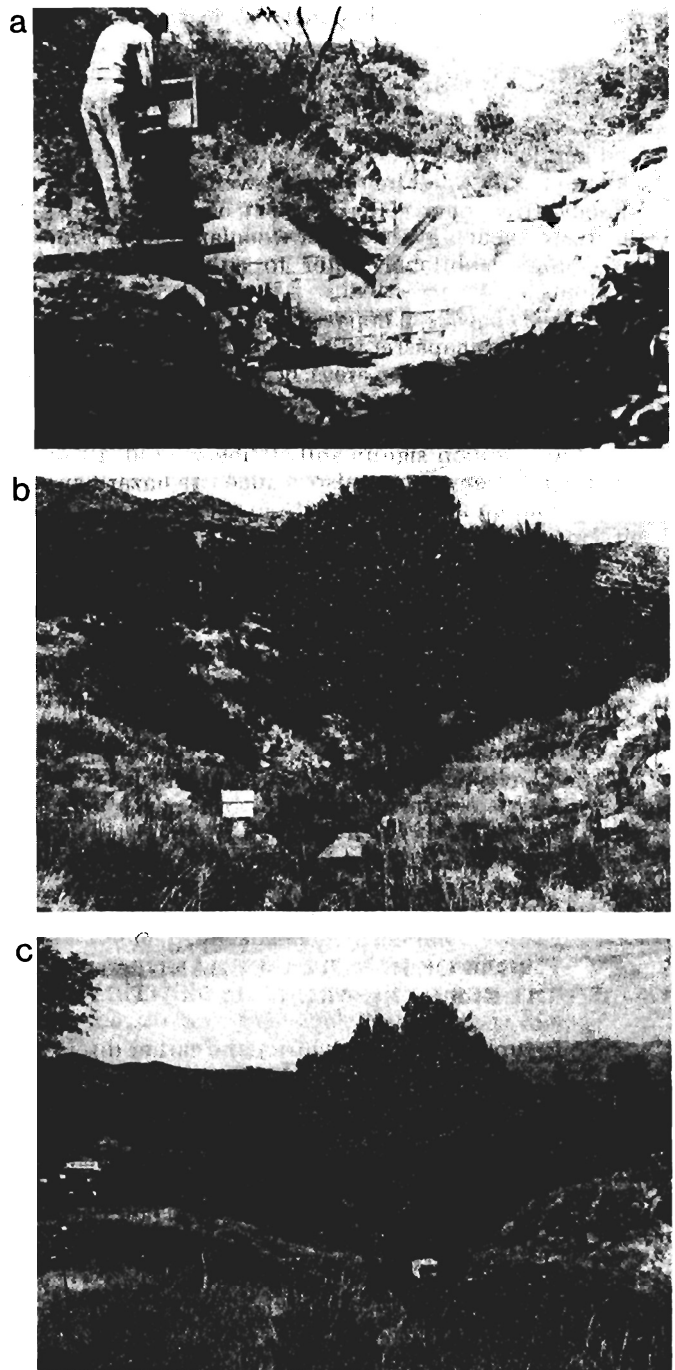

Figure 7.—The appearance of the stream reach immediately above and below the gaging station at Three Bar C: (a) before a wildfire in 1956, (b) in 1972, and (c) in 1983. Riparian invasion was removed regularly above the gaging station to prevent interference of trees and shrubs with streamflow measurements.

The greatest potential increase in annual streamflow per acre treated can be obtained by harvesting timber in mixed conifer because this vegetation type receives the greatest amount of annual precipitation (Hibbert 1979). Substantial increases also occur during timber harvesting in ponderosa pine. In both these commercial forest types, however, water yield increases resulting from the effect of timber harvesting on snowmelt occur mainly during spring when water use by riparian plants is lowest. Duration of streamflow is not changed substantially by timber harvesting in either ponderosa pine or mixed conifer forests. In southwestern pinyon-juniper woodlands, only small increases in water yield can be obtained by tree removal (Baker 1984), making it unlikely the treatment of pinyon-juniper woodlands would produce enough additional water to enhance riparian ecosystems.

In the final analysis, it appears brush-to-grass conversion in Arizona chaparral is a promising management tool for enhancing riparian areas, because it not only produces the second largest increase in water yield per acre treated, following mixed conifer, but also increases streamflow duration significantly (Hibbert et al. 1974). Brush-to-grass conversions also reduce fire hazard and increase wildlife habitat diversity in the riparian area itself. However, care must be exercised so that existing riparian communities in untreated chaparral are not endangered by the treatment (see the case study at Monroe Canyon under intermediate structures presented later). Also, it is important to note that grasslands produced during a brush-to-grass conversion, particularly when reseeded with aggressive exotic grasses, may have lower bird population densities, species richness, and diversity than the former chaparral cover. However, judicious chaparral conversion projects producing a brush-grass mosaic pattern appear to be a viable management strategy for enhancing the hydrology of riparian areas while, at the same time, maintaining water yield increases and habitat diversity.

THE ROLE OF IN-STREAM CHANNEL STRUCTURES IN RIPARIAN HYDROLOGY

Many principles established during the earlier discussion on gully rehabilitation also hold true for larger man-made channel structures and for various-sized natural structures. For example, duration of streamflow can be lengthened with both naturally occurring and man-made channel structures. Natural channel structures consist of fallen logs imbedded in the stream channel (log steps), large boulders, beaver dams, accumulations of large woody debris, and cienegas. Man-made structures include large flood control structures, intermediate-sized erosion control dams, and the small check dams (gully plugs) discussed earlier.

All channel structures capture and immobilize some sediment. However, they may vary in their capacity to regulate flow. Cienegas and large flood control structures both pond ground water and store sediment, whereas small check dams mainly store sediment and reduce flow

energies. Although man-made structures may not necessarily store surface water, they provide temporary channel storage of flood waters, which affects the timing and duration of streamflow through downstream reaches. The improved hydrologic regime created by channel structures not only improves riparian habitat but also has implications for managing in-stream flows (Van Haveren 1986).

Small channel structures are most important on low-order streams in upland watersheds where riparian ecosystems consist of small stringers of trees and brush occupying the channel and banks in the immediate vicinity of the stream. In contrast, downstream riparian ecosystems associated with larger channel structures occupy extensive floodplain areas along larger order rivers passing through lower elevation desert environments.

Naturally Occurring In-Stream Channel Structures

Several types of channel structures created by naturally occurring processes can create environments favoring establishment of riparian ecosystems. The most important natural structures are cienegas, log steps in smaller streams, debris accumulation in larger streams, and beaver dams.

Cienegas

The term cienega was coined by Spanish explorers in the southwestern United States to describe riparian marshlands (Hendrickson and Minckley 1985). Cienegas are mid-elevation (3,300-6,600 feet) wetlands characterized by permanently saturated, highly organic, reducing soils. The flora is dominated by low sedges that are highly adapted to soil characteristics found in these habitats.

Under natural conditions, cienegas evolve after the soils in an area have passed through a series of aggradation and degradation steps following channel obstruction (Hendrickson and Minckley 1985, Melton 1965). Obstructions can occur because of slow uplifting or intrusion of bedrock across a drainage channel, which may span thousands of years, or in other cases, occur quickly as during catastrophic events such as earthquakes (Mackintosh 1984). Very active first- and second-order tributaries may deposit coarse material as alluvial fans and obstruct channels in higher order, steep-walled drainages. These alluvial fans effectively act as channel controls that reduce slope gradients and encourage deposition of materials. Also, sediment deposits and subsequent sinuous channel forms favor riparian ecosystems. Similar channel controls result from mud-rock flows and landslides that add more material to the channel than it has stream power to remove. These geomorphic features provide the macro-controls which, along with input of ground water from regional aquifers (Jackson et al. 1987), initiate cienega formation. Subsequent ponding of alluvial ground water and trapping of sediment initiates riparian plant establishment and succession.

Vegetation establishment on the cienegas, combined with their relatively flat topography, effectively dissipates energy and fosters sediment and organic matter deposition which, in turn, improves infiltration of water. Over time, a diverse riparian ecosystem becomes established and is maintained unless subjected to severe disturbance. Ultimately, these deposits are sustained by the cienega vegetation at slopes that are highly vulnerable to concentrated flows or other small alterations in the form, or cover, of the cienega. Under these conditions, linear perturbation such as trails, or breaks in plant cover, can cause rapid downcutting and eventual destruction of the cienega. Major deposits of sediment from tributaries can also trigger a series of discontinuous headcuts that ultimately lead to dewatering of the cienega.

Streamside Vegetation and Organic Debris Accumulation

Forest and riparian plant communities along small streams act as both erosion buffer strips (Heede 1988) and nutrient filters (Cooper and Gilliam 1987, Lowrance et al. 1984c). In upland areas, these plant communities can affect the streamflow hydraulics and channel dynamics of small mountain streams (Heede 1985a, 1985b; Megahan 1982; Swanson et al. 1984). This occurs when trees and logs fall across the channel and are incorporated into the hydraulic geometry of the stream channel, creating log steps (figs. 8a and 8b) (Heede 1981). When this organic debris accumulates on the streambanks, it improves channel stability by promoting soil development, increasing infiltration, and reducing overland flow and bank erosion. The log steps in the stream channel accumulate sediment, thereby reducing the channel gradient and improving channel stability. Waterfalls then develop over each step which further reduces flow energies substantially (fig. 8c). When log steps are submerged during high flows, they contribute to the channel roughness and further decrease flow velocities. In natural systems, these log steps rot and are eventually replaced by newly fallen limbs and trees in order to maintain dynamic equilibrium. While these log steps are in place, they store sediment which would otherwise be lost downstream. As a result, these log steps and other debris accumulations provide a mechanism for enabling alluvial deposition and the formation of alluvial aquifers, which encourage the establishment of riparian vegetation along these small upland streams in the Southwest.

Large-particulate organic debris accumulations in channels also play an important role in maintaining riparian ecosystems along the larger, low-elevation rivers of the Southwest (Minckley and Rinne 1985). In this desert stream environment, large accumulations of debris function as sources of nutrients and also provide a quasi-stable environment in an otherwise unstable system. However, riparian ecosystems can become so dense that they fully occupy the channels and cause flooding, as has been reported along the lower elevation reaches of the Salt and Gila Rivers in Arizona (Graf 1980).

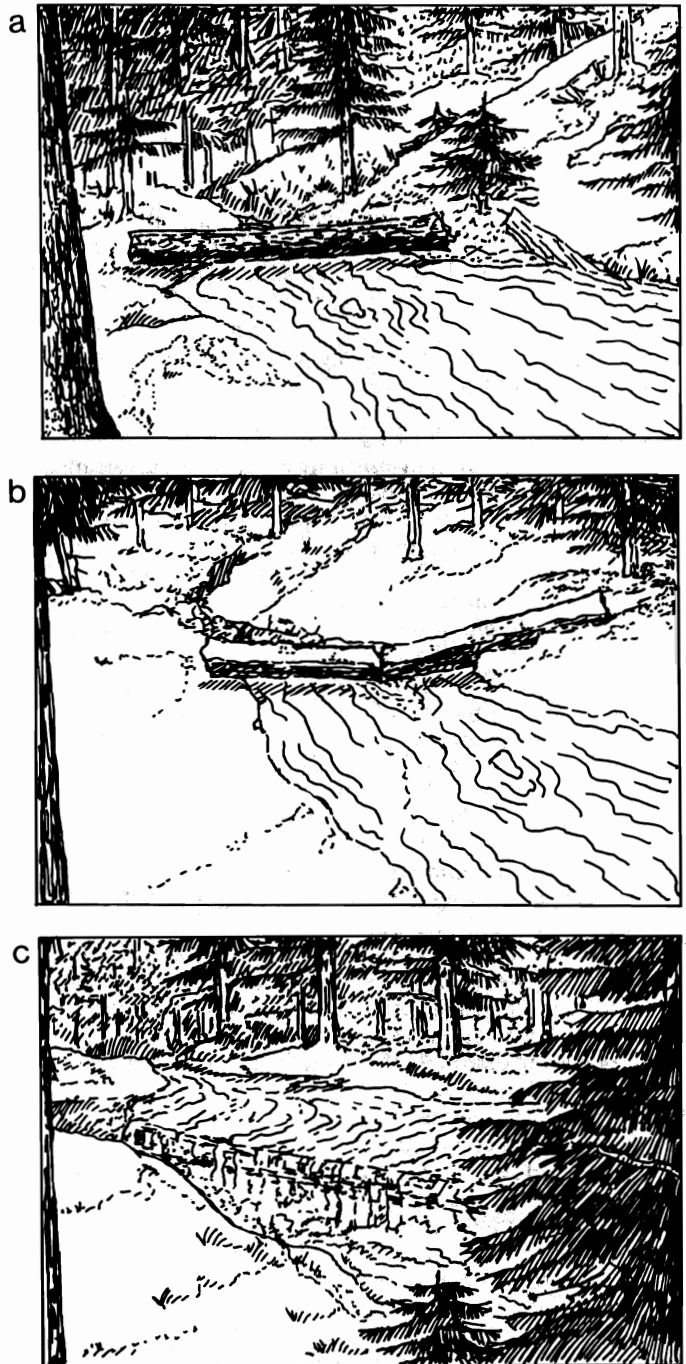

Figure 8.—Log steps form when a log falls across a stream (a) and becomes incorporated into the channel geometry (b) where it effectively acts as an energy dissipator (c) (Heede 1981).

These riparian areas formerly supported stands of willows, cottonwoods, and mesquite bogs, but have recently been replaced with dense stands of saltcedar. The former riparian species were removed for fuel and lumber during settlement of Arizona. Currently, several thousand acres of former riparian areas are covered with saltcedar. Although the establishment of a new habitat

has benefited some wildlife populations, it has caused serious flooding problems that have invoked legal, institutional, and economic concerns (Graf 1980).

Beaver Dams

Beaver dams also create favorable channel environments for riparian ecosystems (Parker et al. 1985, Skinner 1986). These dams usually extend fully across a channel and act as a very wide weir during flood peaks, which affects the hydraulic regime in at least two ways. First, flood waters are spread over a wider area, which reduces the hydraulic head. This changes highly turbulent flow into more tranquil flow, which decreases the erosional energy of flowing water. Secondly, peak discharges during runoff events may be dissipated, because these dams have some water retention capacity. The dams can also improve water quality by reducing the concentrations of suspended solids, total nitrogen, and total phosphorus (Parker et al. 1985). The retention of sediment and nutrients, as well as the level valley geometry, both encourage long-term cienega formation and establishment of riparian ecosystems.

Beaver dams need special consideration because they are built according to different engineering standards than man-made structures, and are dependent upon stable beaver populations (DeBano and Heede 1987). Beavers build level dams simulating very wide weirs which limit flow heads and velocities at high volume flows. As a result, the dams have much less concentrated flow to deal with compared to typical man-made structures that have a single spillway which constricts flow. Beavers also initially tend to build dams in a downstream to upstream direction because they need ponded water to provide a means of transporting material to the next dam site in safety. This often produces a plunge pool immediately below successive upstream dams. These two factors largely eliminate the need for a splash apron and back protection below the structure which are typically required in man-made structures.

The upstream construction pattern captures sediments that render downstream dams less effective for beaver habitat. It also creates a system where previous channels become ambiguous and produce a very sinuous pathway for streamflow. The lower slopes and energies may allow a new channel equilibrium to develop that differs substantially from the previous pattern.

Beaver dams are stable on watersheds in good condition where beaver populations are also stable. When animals are removed from a given stream reach, as occurred during the 1840's (Quaife 1930), the dams are no longer maintained. The removal of the beaver populations coupled with exposure to flashy flows can remove all dams in a domino-fashion because often, when one beaver dam is lost, all downstream dams will also be demolished due to developing water-sediment surges. Flow and sediment surges, fed by extensive water and sediment accumulations in the beaver ponds, can cause extensive channel damage. Failure of dams causes a loss in stored ground water, and riparian ecosystems col-

lapse. As a result, it appears beaver dam upkeep, or replacement by a human version, must be part of effective beaver dam management. Upkeep requires maintenance of a balance between existing structural material for dams, food supply, and animal numbers.

Beavers should be introduced, or reestablished, for improving riparian areas, but only where adequate food sources are available. For example, where there is little or no riparian vegetation and trees are widely scattered, it may be necessary to control beaver populations so that the struggling riparian vegetation can become established and provide an adequate food supply.

Synopsis

Land managers need to be aware of the opportunities for riparian improvement provided by naturally occurring mechanisms. The most common are log steps, cienegas, and beaver dams. Log steps and streamside vegetation on smaller upland streams and watersheds play an important role in regulating both streamflow and nutrient fluxes from these watersheds and, as such, provide an essential moderating link between the watershed and the associated aquatic and riparian ecosystems. Log steps in channels also act as effective natural energy dissipators, and their regular replenishment must be considered when planning timber harvesting or other management activities.

Cienegas created by natural geologic processes pass through several evolutionary stages, some of which are more susceptible to damage than others. As the slopes sustained by cienega vegetation become steeper, they are more vulnerable to linear perturbations such as trails, or breaks in plant cover, which can lead to irreversible damage to these important riparian areas.

Beaver management provides an additional tool for improving riparian areas. Beaver dams, unlike man-made structures, are self-maintaining and are able to accommodate "natural" channel adjustment. However, limited food supplies and increased predation can reduce beaver populations so that dams are no longer maintained and riparian ecosystems are lost.

Although riparian ecosystems usually have beneficial effects, conditions can develop in larger streams at low elevations where excessive plant growth plugs channels and produces unwanted flooding. However, natural structures are in many ways preferable to man-made structures because they are self-maintaining and are capable of adjusting in harmony with channel adjustment and evolution.

Man-Made In-Channel Structures

Channel structures and bank protection structures are examples of man-made devices that can encourage establishment of riparian ecosystems. Channel structures, ranging from large flood control and water storage structures to small check dams (gully plugs), have a similar geomorphic effect as bedrock intrusions during

ciénega formation. Bank protection devices, on the other hand, do not directly obstruct channels but, by deflecting or separating streamflow, can affect nearby riparian areas (DeBano and Heede 1987).

Large Dams

Dams are one of the oldest and most common physical structures used for regulating streamflow. If the structures are designed for water storage, they will retain water until it is needed for downstream use. Flood control structures, on the other hand, only store water temporarily until it can be released safely downstream. Because of their effect on streamflow and sediment transport, large water storage and flood control dams can dramatically influence both upstream and downstream channels and associated riparian ecosystems.

Reservoirs accumulate sediment both at the dam site and in the delta where the stream enters the reservoir because flow velocities are decreased, causing suspended sediment to settle out. As a result, local base levels of the stream rise, causing aggradation in the lower stream reaches. Where bank materials are erodible, this aggradation leads to channel widening and provides excellent habitat for riparian plants. Dense plant cover (especially those consisting of brush and trees) also increases flooding of adjacent floodplains, thereby creating temporary disturbances favoring establishment of riparian ecosystems (Brady et al. 1985, Szaro 1989).

Fine sediments and organic matter deposited upstream from dams are also nutrient-rich. These deposits are not only a fertile medium for plants, but also influence moisture regimes above and below channel structures (Szaro and DeBano 1985). Deposited materials retain water for longer periods, thereby creating a more stable moisture regime for colonizing riparian ecosystems. Unfortunately, these riparian areas in the Southwest are often reoccupied by dense stands of saltcedar, which provide much poorer wildlife habitat than cottonwoods and other native species.

Case study.—A recent study of a flood control dam and reservoir in central Arizona illustrates how a large channel structure can alter streamflow and sediment regimes and enhance the establishment of a riparian ecosystem (Szaro and DeBano 1985). Whitlow Dam was built in 1960 as a flood control structure for temporarily delaying streamflow in Queen Creek by storing about 36,000 acre-feet of floodwater. The structure also stored sediment. By 1975, about 304 million cubic feet of sediment had been stored in the reservoir above the dam. Prior to construction, stream reaches above Whitlow Dam supported mainly Sonoran riparian scrubland (fig. 9a). There were no trees in the streambed, and adjoining banks supported mainly common mesquite, velvet mesquite, and ironwood. Only 7 years after completion, Gooding willow and saltcedar had occupied about 44 acres (fig. 9b). From 1967 to 1980, vegetation increased in both density and size to the 72-acre riparian community present today (figs. 9c and 10).

The rapid development and establishment of a riparian ecosystem above Whitlow Dam was in response to both

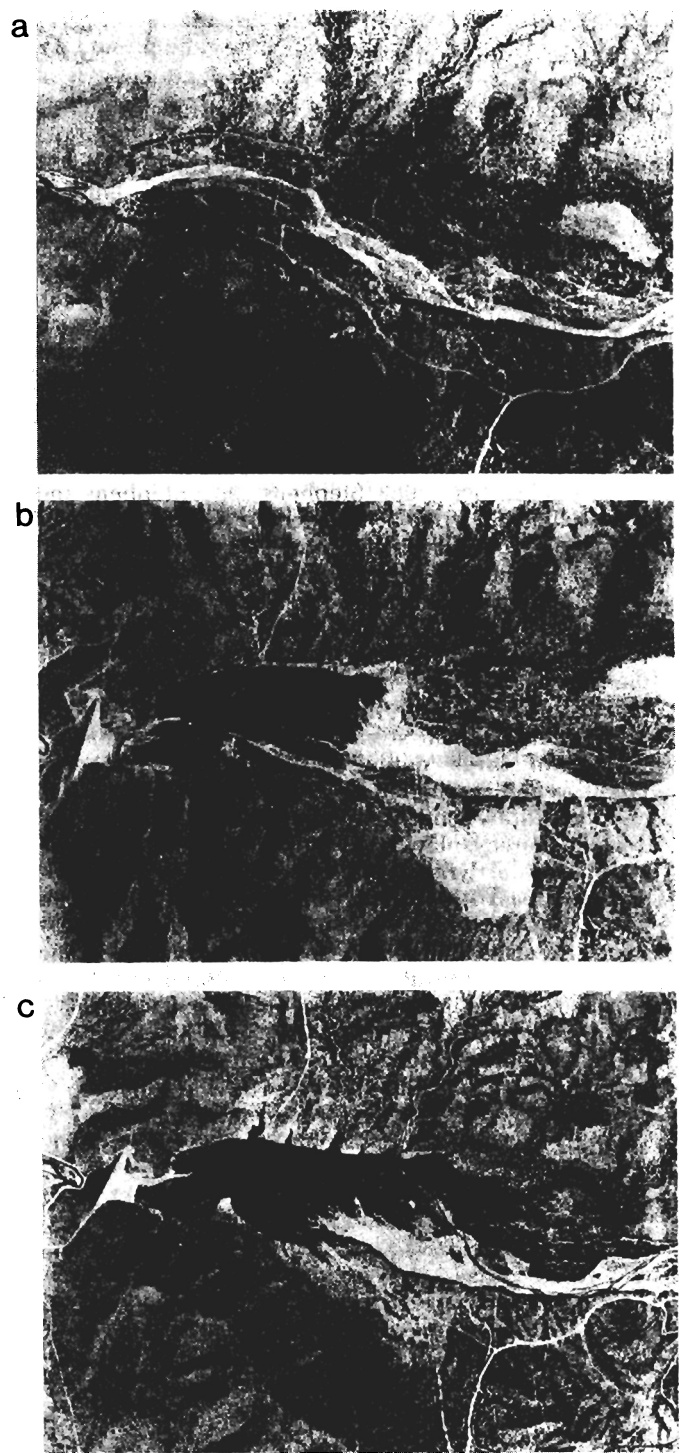

Figure 9.—Aerial photographs showing the development of a riparian plant community above Whitlow Dam in central Arizona between 1960 and 1980: (a) prior to completion of dam in 1960; (b) by June 1967, a 44-acre riparian community had developed above the dam; and (c) by April 1980, a 79-acre riparian plant community was present (Szaro and DeBano 1985).

improved moisture relations and site fertility. Temporary impoundment of water in the reservoir charges both trapped sediment and surrounding reservoir banks with water, which provides nonstorm streamflow for a large part of the year. A hydrologic analysis of the inflow records for the dam over time since its construction in 1960 showed that, had the dam not been present, the channel reach would have only been wetted during stormflows an average of 24 days per year between 1960 and 1983 (fig. 11). In contrast, outflow records indicated that after construction, streamflow occurred about 340 days annually (fig. 11).

Bank recharge may be an important mechanism for enhancing riparian areas in the Southwest. Depending on the nature of bank material, streambank recharge can occur rapidly in semiarid environments along nonperennial streams even in the absence of channel structures (Byers and Stephens 1983, Stephens 1985, Stephens and Knowlton 1986). Up to 26 acre-feet of water per mile of channel has been reported stored in coarse channel alluvium in southern Arizona (Keppel and Renard 1962). Water stored in streambanks may be released slowly over time and significantly extend the duration of streamflow (Cooper and Rorabaugh 1963). Flood control dams or other structures across ephemeral stream channels temporarily impound water, thus allowing more water to be stored in a particular stream reach as bank recharge.

Effect of large dams on downstream channel dynamics and associated riparian ecosystems.—Large dams withdraw both sediment and nutrients from streams, thereby playing an important role in downstream channel dynamics and the welfare of associated riparian areas (Brown and Johnson 1985). Sediment removal by structures produces a stream capable of picking up a fresh sediment load, because the water leaving the dam has excess available energy (DeBano and Heede 1987). Before dam installation, downstream channels are in dynamic equilibrium, supporting a flow carrying a given sediment load. After installation, this equilibrium is lost. A new equilibrium between flow and hydraulic geometry of the channel must develop. It takes time to attain this new equilibrium because stream processes are slow.

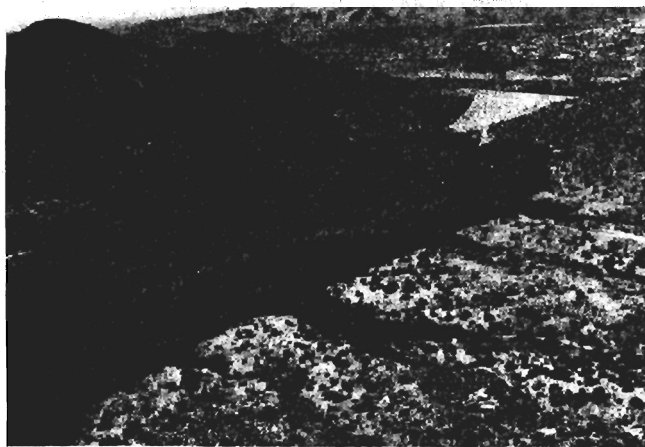

Figure 10.—A 79-acre riparian plant community above Whitlow Dam.

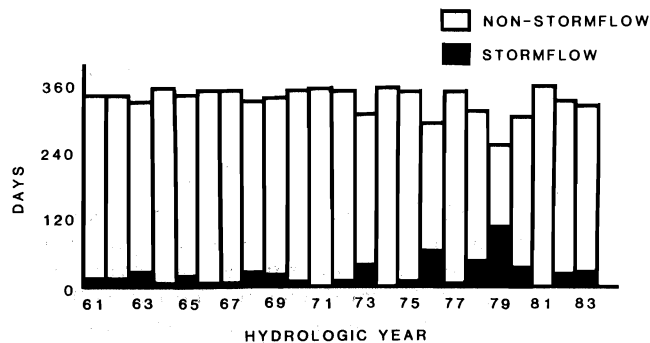

Figure 11.—The number of days per year of storm and nonstorm flow through Whitlow Dam, 1961-1983 (Szaro and DeBano 1985).

One of the most important variables influencing flow energy is channel gradient. A stream carrying less than its potential sediment load requires a gentler gradient (i.e., less free energy) or, theoretically, a rougher bedform. In reality, changes in only bedform or particle size are seldom sufficient for attaining a new equilibrium after sediment load withdrawal. Channel gradients can be decreased by meander formation, or by degradation of the bed. Where banks consist of erosion-resistant materials, or where bank protection measures are installed, lateral stream movement cannot occur. Instead, sediment load will be picked up from the bed, causing degradation and flattening of the gradient over time. Degradation is a long-term, high-energy process. Both degradation and meander formations can destroy existing riparian ecosystems.

A second major effect large dams have on downstream riparian areas is through regulation of streamflow. Although dams are built for different purposes, most decrease peak flows (Williams and Wolman 1984). Large flood control dams may delay storm flows only temporarily, while water storage structures may regulate flow throughout the year except for unexpected "spills" during large flow events that can inundate and damage nearby riparian ecosystems (Stevens and Waring 1985). When flow regulation is substantial, flooding of nearby floodplains may be eliminated. Consequently, aggradation of floodplains does not occur, which is the trigger mechanism for shifting channels. Shifting floodplain channels are required for regeneration of some riparian tree species (Brady et al. 1985, Szaro 1989). Although drastic reductions in flow may harm riparian ecosystems on floodplains removed from the stream channel, the more consistent streamflow favors riparian ecosystems in, or adjacent to, stream channels. Flow regulation may increase low flow and, thereby, be beneficial to riparian ecosystems because it provides a more reliable yearlong source of water (Williams and Wolman 1984).

Substantial decreases in flow discharge can also lead to channel aggradation. When large amounts of sediment are discharged from tributaries, the flow energies in the master stream are not sufficient to transport this material downstream (DeBano and Heede 1987). An alluvial fan then forms at the stream junction, forcing the master stream to create a new channel around the fan by eroding

the opposite bank. This can destroy portions of existing riparian ecosystems. A high frequency of tributaries with large sediment production may throw the stream and its existing riparian ecosystem out of dynamic equilibrium, and only after a new equilibrium has been attained can new riparian ecosystems become established.

The balance between sediment withdrawal and flow regulation on channel dynamics and riparian areas is illustrated by the effect of Glen Canyon Dam on the Colorado River as it flows through the Grand Canyon. The walls and channel bottoms in part of the Grand Canyon are made up of erosion-resistant material, so the most easily available material is not located in the bed but in bars within and alongside the Colorado River (Beus et al. 1985). Because sediment has been removed upstream by Lake Powell, sand on the beaches on this stretch of the Colorado River are being picked up by the relatively sediment-free water. The only depositions occurring at present are during infrequent flooding by the Little Colorado River and other smaller tributaries entering the Grand Canyon below Glenn Canyon Dam, or by unexpected "spills" through Glenn Canyon Dam (Beus et al. 1985). The remaining fluvial deposits have been transformed from barren strips on both sides of the river to dynamic strips of vegetation because large floods capable of destroying riparian areas have been reduced (Turner and Karpiscak 1980).

Synopsis.—In summary, changes in stream dynamics caused by large dams, along with overgrazing and watershed abuse, must be viewed as the prime reasons for changes in riparian ecosystems (Skinner 1986). Generally, riparian areas increase upstream and may either decrease or increase downstream. Streams carrying less than their potential sediment loads are the main reason for damage to downstream riparian areas, although regulated flow may benefit both up- and downstream riparian ecosystems.

Intermediate-Sized In-Stream Structures

Structures of intermediate size, commonly used for stabilizing channel downcutting and degradation, can stabilize stream reaches, store sediment, and enhance establishment of riparian ecosystems. The structures vary in size but are larger than the channel checks used in small gully networks. Design specifications for these types of structures, which can be used for stabilizing coarse alluvium during riparian zone rehabilitation, have been developed by Jackson and Van Haveren (1984). Although multiple structures in a channel are usually the most effective for riparian enhancement, single structures, particularly if combined with upstream cover manipulations, may serve equally well. Intermediate-sized structures have been constructed for erosion control purposes throughout the West (Lusby and Hadley 1967; Ruby 1973, 1974; Van Haveren et al. 1987).

Case study.—An intermediate-sized flood control structure that contributed to the establishment and development of a riparian community was built in Monroe Canyon on the San Dimas Experimental Forest in southern California. Monroe Canyon is a 865-acre

watershed covered with chamise-chaparral and scrub-oak vegetation types (Hill and Rice 1963). Prior to treatment, about 9 acres of the canyon bottom was occupied by obligate riparian species. Another 25 acres was occupied by oak-woodland. The riparian and oak-woodland sites were harvested in 1958 and 1959 to test water yield responses, and in 1960 the entire watershed was burned by a wildfire. After the fire, brush suppression by hand labor and herbicides was used to convert sideslope sites with deep soils to an annual grass cover.

The combination of vegetation conversion, fire, and large storms during 1965, 1966, and 1969 had a tremendous impact on the channel geometry of Monroe Canyon (Orme and Bailey 1971). At the height of storms in January and February 1969, the entire canyon floor became a veritable debris chute. During the storm periods between 1963-1969, Monroe Canyon lost nearly 2,877 yd³ of materials, over eight times the volume lost from a comparable channel reach in Volfe Canyon where erosion was hindered by vegetation, greater energy losses, and less discharge and debris production (Orme and Bailey 1970). With these powerful erosional processes operating in Monroe Canyon, the channel bottom throughout the watershed remained virtually devoid of any permanent vegetation through the late 1960's and early 1970's.

In 1972, a large flood control structure was constructed at the mouth of Monroe Canyon. This structure was a crib design, 32 feet high and 135 feet wide. The structure was rapidly filled to capacity (3,438 yd³) with coarse debris. By 1978 a small stand of willows had become established upstream from the structure. Vegetation reestablishment was rapid, so by the spring of 1985 a substantial riparian area had become established that extended several hundred yards upstream. The present vegetation is primarily willow and *Baccharis*.

A riparian community also developed below the Monroe Canyon Dam due to the stabilization of a badly eroded channel and from more consistent streamflow provided by upstream brush-to-grass conversions (Hill and Rice 1963). Sediment trapped in the structure stored water, which was released slowly over time. The channel stability coupled with perennial streamflow allowed rapid reestablishment of riparian species. Similar observations were made during a comprehensive survey and analysis of thousands of similar intermediate-sized structures throughout Los Angeles County (Ruby 1973). Establishment of vegetation occurred rapidly and trees were observed occupying debris mounds above dams within 2 years (Ruby 1973).

Effect on channel dynamics.—Intermediate-sized structures function more like smaller channel checks than large dams. Substantial sediment can be withdrawn during the first storms following construction until the upstream reservoir is filled. The sediment deposits above these structures continue to aggregate until pre-dam channel gradient is attained if sufficient sediment is supplied (Van Haveren et al. 1987). Upstream deposition also depends on the permeability of the structure, with the permeable structures maintaining steeper surface gradients than the original stream channels (Lusby and

Hadley 1967). After the storage capacity of the reservoir has been satisfied, additional sediment is carried through the structure and reduces the downstream erosion potential of the stream. At this stage, their effects on downstream erosion are similar to those of small gully plugs.

Bank Protection Structures

Bank protection structures can be grouped into (1) armoring banks, (2) deflecting flows, and (3) separating flows. Armors are designed to keep banks in their present location; deflectors are used for eliminating flow impacts on critical banks; separators divide flow into high and low energy segments. The objective of the latter is to allow only low-energy flows along the banks (DeBano and Heede 1987). All three types can protect and enhance riparian plant communities if correctly designed. However, the third type, because it emulates riparian flow separation effects, yields the greatest benefit for riparian ecosystems. Indeed, enlarging a riparian plant area often is an important objective for attaining bank stability. The need for bank protection structures, as with other man-made structures, should be carefully analyzed within the context of natural adjustment mechanisms so that their success is assured. Continued maintenance and repair is also critical for the success of all types of bank protection structures.

Bank armor usually consists of various kinds of riprap, revetments, gabions, and a variety of other structures installed parallel to a bank and can be constructed according to several designs (Lafayette and Pawelek 1989; Schultze and Wilcox 1985; State of California 1970; U.S. Army 1962, 1984) (fig. 12). Design considerations must include alignment of structures relative to the bank. Smooth transitions from structure to bank on both upstream and downstream ends are necessary to prevent flow separation and eddy development which could lead to bank scour and eventually undermine and erode the riparian ecosystem. Several excellent manuals are available describing the proper installation of these types of bank protection structures (State of California 1970, U.S. Army 1962). Vegetation may also be planted on these structures to stabilize them (Schultze and Wilcox 1985).

Flow deflectors are frequently used for protecting banks and areas adjacent to the channel from the stream's impact. These deflectors can be used to save endangered riparian plant communities. However, careful engineering design is essential so deflected flows do not create new critical locations along the banks (DeBano and Heede 1987). Poor design may protect one side of the stream but cause destruction on opposite stream-banks. Long-term stability of deflection structures depends on the angle between deflector and water flow lines.

Deflectors can produce eddies that scour banks and endanger the deflector. Possible solutions are to keep eddy formations at low-energy levels and to install several deflectors at relatively close intervals. Improperly designed deflectors can constrict stream channels, thereby increasing head-velocity relationships and the

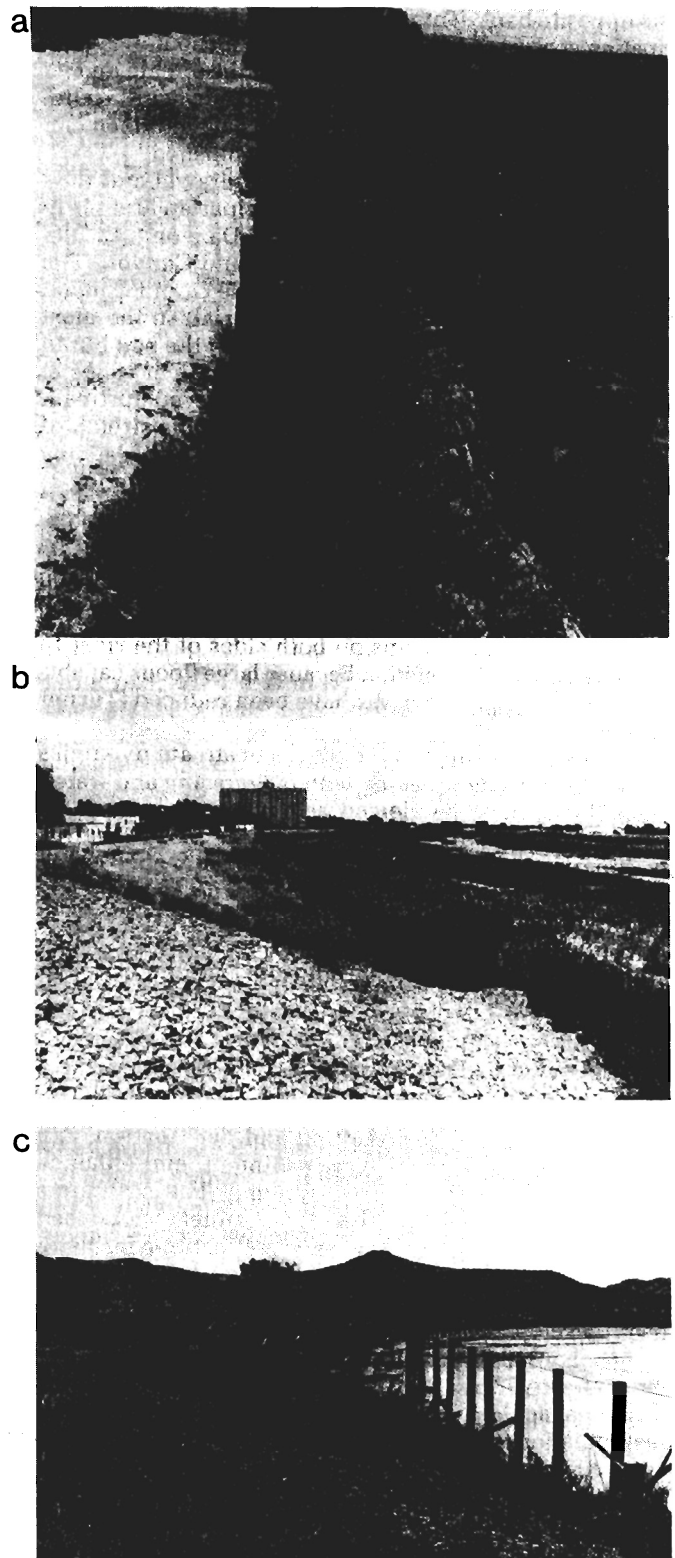

Figure 12.— Commonly used bank armoring and protection devices: (a) revetment posts and gabion near Moab, Utah; (b) jacks and bank armor at Dodge City, Kansas; and (c) jack field behind revetment posts on the Powder River, Wyoming.

potential for erosion. The State of California (1970) and the U.S. Army (1962) have handbooks available describing their proper installation.

Flow separation structures are designed to create low-energy flows along banks. They usually consist of woven wire fences or jack/tetrahedron fields installed at some distance from the bank. One or both banks may be treated because little risk exists for deflected flows. Higher velocities occur outside the fence network (middle of the stream), while reduced flows between fence and bank lead to sediment deposition. Over time, these depositions decrease bank height which, combined with lower flow energies, increase bank stability and may encourage establishment of new riparian ecosystems.

Flow separation structures are practical for increasing bank stability and enhancing riparian plant communities only where channels are wide enough to allow deposition alongside the banks. Best suited are streambeds with high- and low-flow channels. The use of fence revetments is limited to streams having flow magnitudes that will not destroy them. Thus, large rivers may require structures such as jacks or tetrahedrons. These structures increase roughness of flow and produce the same results as fences. However, individual structures must be anchored to each other, in the channel, and to the banks in order to secure their location.

Synopsis

Both naturally occurring and man-made channel structures play an important role in riparian enhancement in select locations throughout the Southwest. As with all other expensive engineering structures, the routine construction of man-made structures is not recommended solely for enhancing riparian areas. However, the potential riparian benefits should be considered when analyzing the costs and benefits associated with structures. Managers need to be aware of, and capitalize on, the wide range opportunities for perpetuating naturally occurring structures such as log steps, large debris accumulations, and beaver dams. Cienega formation involves larger scale long-term geologic processes, thereby limiting the manager's role mainly to that of understanding the processes responsible for their evolution and limiting any disturbances that may endanger them.

WATER USE BY RIPARIAN ECOSYSTEMS

Because water is a scarce resource throughout the Southwest, it is important that managers be able to estimate amounts of water needed for the different uses, including that necessary for sustaining riparian plant communities. This section summarizes the available literature on water use by riparian plants.

Water use by a wide range of riparian ecosystems has been estimated through past research. However, it must be kept in mind that this research was done in two very different environments: (1) downstream floodplains occupied by phreatophytes, and (2) less arid upland sites occupied by forest or chaparral vegetation. It is impor-

tant to distinguish between these two environments when assessing the costs and benefits associated with water use by riparian ecosystems in the Southwest. Although water consumption by riparian species is high in both situations, water use by phreatophytes in desert and semidesert environments is notoriously high. Consequently, past watershed research was concerned mainly with methods of controlling phreatophytes to reduce evapotranspiration and conserve water along large river systems (Bowie and Kam 1968, Campbell 1970, Graf 1980, Horton and Campbell 1974). Some research on water augmentation was also done in upland riparian areas (Baker 1984, 1986; Ffoliott and Throud 1974; Hibbert et al. 1974; Rich and Gottfried 1976; Rowe 1963).

Riparian vegetation in Arizona occupies about 276,000 acres, of which more than 100,000 acres are located at lower elevations along the Gila River (Babcock 1968). The acreage of riparian vegetation occupying upland sites is not precisely known, although the U.S. Forest Service (Southwestern Region) estimates it administers about 240,000 acres of riparian areas in Arizona and New Mexico, most of which are probably classified as upland sites (personal communication, Russell Lafayette, Southwestern Region, USFS).

Lower Elevation Riparian Ecosystems

Lower elevation stream banks are occupied by several riparian species including Gooding willow, Fremont cottonwood, and saltcedar. Saltcedar was introduced into the United States by nurserymen during the early 1800's (Horton 1964) and spread rapidly; it occupied about 890,000 acres of floodplain by 1961 (Horton 1977). Large amounts of water used by phreatophytes, such as saltcedar, have made them attractive species to remove for water augmentation purposes. Sites supporting saltcedar and other riparian species consume 8 to 70 inches of water annually through evapotranspiration (Anderson 1976, Gay 1985, Gay and Hartman 1982, Schumann and Thomsen 1972, Thomsen and Schumann 1968).

Lower elevation riparian ecosystems consume substantial amounts of any additional water gained from treating upstream areas during its conveyance. The fate of this additional water in terms of present, near-future, long-term, and potential evapotranspiration was estimated on 32 intermittent and perennial stream reaches in Arizona (Anderson 1976). Near-future and long-term increases in evapotranspiration were considered negligible for perennial streams, which accounted for about one-half of the streams and two-thirds of the total stream length. Near-future evapotranspiration increased in intermittent stream reaches because shallower water tables were produced when additional water was made available. Long-term future evapotranspiration also increased because riparian vegetation density increased as water became permanently available in areas that were previously intermittent. Estimates of evapotranspiration varied from one reach to another, but usually long-term future consumption is projected at more than double present consumptive use.

The results of a study on conveyance losses were used to estimate potential water use in Tonto Creek above Lake Roosevelt in central Arizona. Tonto Creek is 59 miles long and supports 4,850 acres of riparian vegetation. Estimates of present, near-future, and long-term future evapotranspiration, in millions of cubic feet per year, were 378, 523, and 78, respectively. Thus, it was anticipated that if water yield was increased in Tonto Creek by vegetation from cover manipulations, the first 403 million cubic feet of this increased water could be used along the stream by riparian vegetation unless remedial control were applied to the vegetation. One should not assume from these projections, however, that the first 403 million cubic feet of any annual water yield increase, or even the first 145 million cubic feet (Anderson's near-future losses), would be consumed enroute to Lake Roosevelt. Evapotranspiration occurs largely in the summer, not during the dormant winter season when about 80% of the increase in water yield, resulting from cover manipulations, is produced (Hibbert et al. 1974). Since most of these intermittent streams flow in winter (except for very dry years), any increase in flow, however small, would simply add to the existing flow and little or no additional use should occur enroute to downstream storage. In contrast, increases in summer flow would not fare as well, because when normal streamflow is consumed by riparian vegetation, any extra flow would likely also be consumed. If water yield is increased to create perennial flow in formerly intermittent streams, then further depletion of summer flows will eventually reach a maximum rate (Anderson's long-term future losses), after which use would remain constant. However, in the interim, transitory use of water should be no greater than 2% of the water yield increases unless the stream normally does not flow at least part of each year. In this event, increases might be completely absorbed into dry channels and bank alluvium.

Upland Riparian Zone Water Use

Evapotranspiration from upland riparian zones varies widely, depending on elevation, presence and depth of water in alluvium, and type and density of vegetation. Three studies, two in Arizona and one in southern California, provide estimates of evapotranspiration rates from upland riparian areas.

Rich and Gottfried (1976) found that removal of bigtooth maple, Arizona alder, and Arizona walnut from a narrow riparian zone along the north fork of Workman Creek at 4,300 to 7,000 feet elevation in central Arizona, caused no detectable changes in daily fluctuations or annual or growing season streamflow. Bowie and Kam (1968) studied water use along a 1.5-mile stream reach on Cottonwood Wash in northwestern Arizona at an elevation of 4,000 to 4,300 feet. Treatments were applied to defoliate and eradicate riparian vegetation, mostly cottonwoods and willows, along a 22-acre floodplain about 121 feet wide. Defoliation produced only small and short-lived reductions in water use by riparian vegetation. Eradication, on the other hand, reduced water consump-

tion on the 22 acres from 32 million cubic feet (3.6 feet deep) to 18 million cubic feet (2.0 feet) per growing season for 3 years.

Rowe (1963) reported water was saved when woodland-riparian vegetation was cut along 1.3 miles of Monroe Canyon in the San Gabriel Mountains of southern California. Evapotranspiration in Monroe Canyon was estimated to be between 4 and 5 feet annually in areas at elevations from 2,000 to 2,500 feet. Only about 10% of the area cleared (34 acres) supported riparian plant communities. When the increases in water were prorated over the acreage treated, flow increased more than 1.2 acre feet annually per acre treated.

Synopsis

When evaluating actual or potential water use by riparian vegetation, a clear distinction must be made between small stringers of riparian vegetation along upland streams and extensive riparian ecosystems occupying the lower elevation rivers and floodplains in desert environments. Important differences include season and duration of water flow and use, aridity of environment, and size of individual riparian ecosystems.

In upland environments, the most effective precipitation and streamflow occurs during winter, when riparian plants are dormant and using little water. Therefore, during winter only a small portion of the available water is used by riparian ecosystems located at the higher elevations. During summer, however, these upland riparian communities are using a maximum of water, although the amount used per unit area is probably less than the riparian ecosystems in the more arid desert environment where the evapotranspiration potential is notoriously high. Currently, there are no definitive inventories of the total riparian areas in each environment, although individual ecosystems are much larger along the rivers in the lower elevation deserts (e.g., Gila River in Arizona). However, there are some indications that, by innovatively managing the depth to the water table below floodplains supporting phreatophytes in these desert environments, water may be conserved by reducing evapotranspiration without jeopardizing the integrity of the riparian ecosystem (Ritzi et al. 1985).

RESEARCH NEEDS

Although land managers are implementing numerous watershed practices that improve riparian area hydrology, our present understanding of the effect of specific watershed treatments on the dominant hydrologic processes operating in these riparian areas is incomplete. Research is needed to better clarify: (1) specific sequences of treatments needed for establishing an acceptable balance between watershed condition and riparian health as related to different management objectives; (2) the role of sideslope vegetation on channel processes, such as peak flow generation and sediment transport (Gregory et al. 1985); (3) the role of riparian communities

on nutrient dynamics, sediment transport, and contaminant capture in associated streams (e.g., "nutrient sinks," denitrification in moist stream environments, etc.); (4) the dynamic exchange of water between surface and ground water sources and its effect on associated riparian ecosystems (e.g., streambank and alluvial fan recharge, ground water recharge, etc.); (5) long-term success, proper location, and role of channel structures in riparian enhancement (Platts and Rinne 1985); and (6) evolution of incised channel systems and the long-term role of channel structures in riparian rehabilitation.

Much has been written about the effect of plant cover and general watershed condition on infiltration, runoff, and erosion. Good watershed condition is generally accepted as a prerequisite for maintaining a healthy riparian community. However, the reversibility of degraded watershed condition is poorly defined. Likewise, the dynamic balance between watershed and channel parameters during rehabilitation of badly deteriorated watersheds is not well understood, particularly at any specific point in time. A better quantification of the balance between watershed condition and riparian health is needed for effective management of existing, or potential, riparian ecosystems throughout the Southwest.

Riparian areas act as active sinks for nutrients, organic matter, and contaminants (Lowrance et al. 1984a, 1984b, 1984c). Streamside vegetation traps both sediment and chemicals generated on agricultural uplands before they are transported to nearby stream channels (Hayes et al. 1979; Lowrance et al. 1985, 1986; Peterjohn and Correll 1984; Peverly 1982; Schlusser and Karr 1981a, 1981b). If these nutrient sinks, or buffer strips, are also active in upland riparian areas, they may play a key role in controlling downstream movement of nutrients, sediment, and contaminants released during different watershed treatments. This filtering effect could be an important consideration when managing downstream nitrate contamination produced by converting chaparral to grass (Davis 1985, Riggan et al. 1985). In Arizona, nitrate concentrations of stream water were found to increase from less than 1 part per million, prior to brush control, to as high as 60 to 69 parts per million the third and fourth year following brush control (Davis 1985). The effect of riparian stringers on nitrate concentrations in upland stream environments in Arizona has not been quantified, although riparian forest and wetland ecosystems in the headwater watersheds of Lake Tahoe were found capable of removing 99% of the incoming nitrate nitrogen (Rhodes et al. 1985). If this level of removal was possible during operational scale brush-to-grass conversions in Arizona, then riparian stringers produced, as a result of these conversions, could play an important role in reducing nitrate levels in streamflow before it reached downstream domestic uses.

Although the overall, but not unqualified, beneficial effect of channel structures on hydrologic regimes in riparian areas has been well documented by numerous case studies, criteria have not been developed to identify the incised channels needing treatment and those which will heal naturally. Little is known about the

amounts and rates of water recharge, storage, and release from sediment accumulations and adjoining banks in impoundment areas upstream from structures. Rate and amount of bank and sediment recharge and water storage along with the subsequent release of this water slowly over time needs to be better quantified so the effect of channel structure size on potential riparian areas can be more precisely identified during land management planning.

SUMMARY AND CONCLUSIONS

Management of riparian areas is a critical issue in the southwestern United States. Riparian areas are recognized as unique and valuable habitats whose welfare strongly depends on the health of the surrounding watershed. These riparian areas are found in two distinctly different environments—along small streams in higher elevation uplands, and the large downstream rivers which pass through hot desert environments. Large-scale perturbations (overgrazing, timber harvesting, poor road construction, fuelwood cutting, etc.) of watersheds and associated riparian areas in the 19th century, coupled with emphasis on water yield augmentation in the mid-20th century, led to the degradation of many naturally occurring riparian areas throughout the Southwest.

Land managers are currently implementing a variety of watershed treatments that can improve the structural attributes of riparian ecosystems. In some cases, these treatments may not have been designed for improving riparian areas. However, they have created a more stable environment and favorable hydrologic regime which, in turn, has allowed riparian ecosystems to become established. The most obvious practices benefiting riparian areas are upstream treatments aimed at improving watershed condition, increasing duration of streamflow while moderating flood peaks, and stabilizing channels to reduce erosion.

Improving watershed condition involves improved land use management, which is sometimes supplemented by cultural treatments, to increase plant cover and vigor. Mechanical stabilization of channels may become a necessary part of restoration treatment when significant gully erosion has occurred. Additional water can be obtained for upland ecosystems by reducing evapotranspiration losses through plant cover manipulations and harvesting.

Man-made and naturally occurring channel structures play an important role in riparian management strategies in the Southwest. Large dams for flood control or water storage can both stabilize erodible channels and extend streamflow duration by trapping sediment in upstream deposits, which then store and release water slowly over time. Perennial streamflow may result. Deposited sediments also provide a nutrient-rich substrate favoring plant establishment and growth. Networks of small- and intermediate-sized dams can produce an effect similar to that obtained from large structures. Several naturally occurring processes, operating at different scales, provide the basis for floodplain and associated

riparian development. These include changes in channel slope resulting from landslides, alluvial fans, log-step formation, beaver dam construction, and larger scale geologic changes, such as cienega formation. Managing these naturally occurring and man-made riparian ecosystems requires understanding the hydrologic and hydraulic processes responsible for their formation.

Channel structures for rehabilitating riparian areas cannot be installed without some risk. Channel aggradation induced by structures may be of such magnitude that existing riparian zones are buried. On the other hand, if the structure is large enough to remove most of the sediment load, it may cause erosion in downstream riparian areas because the sediment-free water has sufficient free energy to pick up and transport sediment. Also, if a dense riparian community obstructs the spillway of a small dam, it may divert flood flows around the structure and erode formerly stable areas.

Establishing and maintaining riparian areas require tradeoffs among various uses, including recreation, wildlife and fisheries habitat, grazing, and water yield augmentation. On upland areas, the use of available water by riparian stringers is probably minimal because most water production and streamflow occur mainly during the winter when evapotranspiration is lowest. Establishment and maintenance of these riparian zones appear to depend heavily on the timing of streamflow rather than total increases in water production. This is the reason temporary storage devices such as channel structures are effective for promoting riparian establishment. At lower elevations, evapotranspiration losses are high and the cost of sustaining riparian ecosystems is more expensive in terms of water consumption.

Although many fundamental hydrologic principles are applicable to riparian zone hydrology, the site-specific role of different watershed treatments in successful rehabilitation of deteriorated watersheds has not been well defined. An understanding of the dynamic balance between watershed condition and riparian health for specific sites is also necessary for managing existing or identifying potential riparian areas. Additional research is needed on channel evolution and the role of channel structures in rehabilitation of incised channel systems and riparian areas. Engineered structures that best emulate the natural attributes of riparian areas are not well known. The relationships between nutrient cycling, bank recharge, and streamflow resulting from installation of different sizes of channel structures are other important areas for future research.

In summary, healthy riparian areas reflect sound watershed conditions. Riparian areas provide the final natural treatment of watershed flows to filter sediments, remove nutrients, control water temperatures, and regulate base and flood flows. These areas must be considered in a watershed context, because all tributary effects accumulate to influence riparian health and stability. Upland watersheds in good condition absorb storm energies, regulate storm flows through the soil mantle, and, as a result, provide stability to the entire watershed. This, in turn, provides sustained flows necessary for supporting healthy riparian ecosystems. In contrast, abused

watersheds have developed expanded channel networks in response to increased surface flows. These networks maintain undesirable flashy runoff and available sediment. Watershed and channel treatments are often required in conjunction with improved land use management to rehabilitate these problems.

Successful treatment programs require a clear picture of the desired balance between riparian health and watershed condition; an understanding of departures from this desired balance enables managers to select the best combination of management and treatments needed to improve riparian health. The basic knowledge for improving watershed and riparian areas is generally available. However, the key to successful rehabilitation lies not only in the wise and timely application of management principles and technology, but also requires establishing predictable and quantifiable treatment goals.

LITERATURE CITED

- Anderson, E. W. 1987. Riparian area definition—a viewpoint. *Rangelands*. 9: 70.
- Anderson, T. W. 1976. Evapotranspiration losses from flood plain areas in central Arizona. Open File Rep. 76-864. Washington, DC: U.S. Geological Survey. 60 p.
- Asplund, Kenneth K.; Gooch, Michael T. 1988. Geomorphology and distributional ecology of Fremont cottonwood (*Populus fremontii*) in a desert riparian canyon. *Desert Plants*. 9: 17-27.
- Babcock, H. M. 1968. The phreatophyte problem in Arizona. Arizona Watershed Symposium, Proceedings. 12: 34-36.
- Bailey, Reed W.; Copeland, Otis L. 1961. Vegetation and engineering structures in flood and erosion control. Unnumbered Publication. Ogden, UT: U.S. Department of Agriculture, Forest Service, Intermountain Forest and Range Experiment Station. 23 p.
- Bailey, R. W.; Craddock, G. W.; Croft, A. R. 1947. Watershed management for summer flood control in Utah. Misc. Publ. 630. Washington, DC: U.S. Department of Agriculture. 24 p.
- Baker, Malchus B. 1984. Changes in streamflow in an herbicide-treated pinyon-juniper watershed in Arizona. *Water Resources Research*. 20:1639-1642.
- Baker, Malchus B. 1986. Effects of ponderosa pine treatments on water yield in Arizona. *Water Resources Research*. 22:67-73.
- Barro, S. C.; Conard, S. G. 1987. Use of ryegrass seeding as an emergency revegetation measure in chaparral ecosystems. Gen. Tech. Rep. PSW-102. Berkeley, CA: U.S. Department of Agriculture, Forest Service, Pacific Southwest Forest and Range Experiment Station. 12 p.
- Baurne, Goran. 1984. "Trap-dams": artificial subsurface storage of water. *Water International*. 9:2-9.
- Beus, Stanley S.; Carothers, Steven W.; Avery, Charles C. 1985. Topographic changes in fluvial terrace deposits used in campsite beaches along the Colorado River in the Grand Canyon. *Journal of the Arizona-Nevada Academy of Science*. 20:111-120.

- Bowie, J.E.; Kam, W. 1968. Use of water by riparian vegetation, Cottonwood Wash, Arizona. Water Supply Pap. 1858. Washington, DC: U.S. Geological Survey. 62 p.
- Bradford, J. M.; Piest, R. F. 1977. Gully wall stability in loess-derived alluvium. *Soil Science Society of America Journal*. 41: 115-122.
- Brady, W.; Patton, D. R.; Paxson, J. 1985. The development of southwestern riparian gallery forests. In: Johnson, R. R.; Ziebell, C. D.; Patton, D. R.; Ffolliott, P. F.; Hamre, R. H., tech. coords. Riparian ecosystems and their management: reconciling conflicting uses: first North American riparian conference; 1985 April 16-18; Tucson, AZ. Gen. Tech. Rep. RM-120. Fort Collins, CO: U.S. Department of Agriculture, Forest Service, Rocky Mountain Forest and Range Experiment Station: 39-43.
- Brinson, M. M.; Swift, B. L.; Plantico, R. C.; Barclay, J. S. 1981. Riparian ecosystems: their ecology and status. Biological Services Program FWS/OBS-81/17. Kearneysville, WV: U.S. Department of Interior, Fish and Wildlife Service. 154 p.
- Brown, Bryan T.; Johnson, R. Roy. 1985. Glen Canyon Dam, fluctuating water levels, and riparian breeding birds: the need for management compromise on the Colorado River in Grand Canyon. In: Johnson, R. R.; Ziebell, C. D.; Patton, D. R.; Ffolliott, P. F.; Hamre, R. H., tech. coords. Riparian ecosystems and their management: reconciling conflicting uses: first North American riparian conference; 1985 April 16-18; Tucson, AZ. Gen. Tech. Rep. RM-120. Fort Collins, CO: U.S. Department of Agriculture, Forest Service, Rocky Mountain Forest and Range Experiment Station: 76-80.
- Byers, E.; Stephens, D. B. 1983. Statistical and stochastic analyses of hydraulic conductivity and particle-size in a fluvial sand. *Soil Science Society of America Journal*. 47:1072-1081.
- Campbell, C. J. 1970. Ecological implications of riparian vegetation management. *Journal of Soil and Water Conservation*. 25:49-52.
- Carlston, C. W. 1963. Drainage density and streamflow. Prof. Pap. 422-C. Washington, DC: U.S. Geological Survey. 8 p.
- Conrad, J. Bahre; Hutchinson, Charles F. 1985. Impact of historic fuelwood cutting on the semidesert woodlands of southeastern Arizona. *Journal of Forest History*. 29:175-186.
- Cooke, R. U.; Reeves, R. W. 1976. Arroyos and environmental change in the American Southwest. London: Oxford University Press. 413 p.
- Cooper, H. H., Jr.; Rorabaugh, M. I. 1963. Ground-water movements and bank storage due to flood stages in surface streams. Water Supply Paper 1536-J. Washington, DC: U.S. Geological Survey: 343-366.
- Cooper, J. R.; Gilliam, J. W. 1987. Phosphorus redistribution from cultivated fields into riparian areas. *Soil Science Society of America Journal*. 51:1600-1604.
- Copeland, O. L. 1960. Watershed restoration, a photo-record of conservation practices applied in the Wasatch Mountains of Utah. *Journal of Soil and Water Conservation*. 15:105-120.
- Craddock, George W.; Pearce, C. Kenneth. 1938. Surface runoff and erosion on granitic mountain soils as influenced by range cover, soil disturbance, slope and precipitation intensity. Circular 482. Washington, DC: U.S. Department of Agriculture. 24 p.
- Davis, E. A. 1985. Conversion of Arizona chaparral to grass increases water yield and nitrate loss. *Water Resources Research*. 20:1643-1649.
- DeBano, L. F. 1977. Influence of forest practices on water yield, channel stability, erosion, and sedimentation in the Southwest. In: Proceedings of Society of American Forestry National Convention: 1977 October 2-6; Albuquerque, NM. Washington, DC: Society of American Forestry: 74-78.
- DeBano, L. F.; Brejda, J. J.; Brock, J. H. 1984. Enhancement of riparian vegetation following shrub control in Arizona chaparral. *Journal of Soil and Water Conservation*. 39:317-320.
- DeBano, Leonard F.; Hansen, William R. 1989. Rehabilitating depleted riparian areas using channel structures. In: Gresswell, Robert E.; Barton, Bruce A.; Kershner, Jeffrey L., tech. eds. Practical approaches to riparian resource management: proceedings of an educational workshop; 1989 May 8-11; Billings, MT. Billings, MT: U.S. Bureau of Land Management: 141-148.
- DeBano, L. F.; Heede, B. H. 1987. Enhancement of riparian ecosystems with channel structures. *Water Resources Bulletin*. 23:463-470.
- DeBano, Leonard F.; Schmidt, Larry J. 1989. Interrelationships between watershed condition and riparian health in southwestern United States. In: Gresswell, Robert E.; Barton, Bruce A.; Kershner, Jeffrey L., tech. eds. Practical approaches to riparian resource management: proceedings of an educational workshop; 1989 May 8-11; Billings, MT. Billings, MT: U.S. Bureau of Land Management: 45-52.
- DeByle, Norbert V. 1970a. Do contour trenches reduce wet-mantle flood peaks? Res. Note INT-108. Ogden, UT: U.S. Department of Agriculture, Forest Service, Intermountain Forest and Range Experiment Station. 8 p.
- DeByle, Norbert V. 1970b. Infiltration in contour trenches in the Sierra Nevada. Res. Note INT-115. U.S. Department of Agriculture, Forest Service, Intermountain Forest and Range Experiment Station. 5 p.
- Dobyns, H.F. 1981. From fire to flood: historic human destruction of Sonoran Desert Riverine Oases. Socorro, NM: Ballena Press. 222 p.
- Dortignac, E. J.; Love, L. D. 1960. Relation of plant cover to infiltration and erosion in ponderosa pine forests of Colorado. *Transactions of the American Society of Agricultural Engineering*. 3:58-61.
- Doty, Robert D. 1971. Contour trenching effects on streamflow from a Utah watershed. Res. Pap. INT-95. Ogden, UT: U.S. Department of Agriculture, Forest Service, Intermountain Forest and Range Experiment Station. 19 p.

- Doty, Robert D. 1972. Soil water distribution on a contour-trenched area. Res. Note INT-163. Ogden, UT: U.S. Department of Agriculture, Forest Service, Intermountain Forest and Range Experiment Station. 5 p.
- Ellison, L. 1954. Subalpine vegetation of the Wasatch Plateau, Utah. Ecological Monograph. 24:89-184.
- Elmore, Wayne; Beschta, Robert L. 1987. Riparian areas: perceptions in management. Rangelands. 9:260-265.
- Ffolliott, Peter F.; Thorud, David B. 1974. Vegetation management for increased water yield in Arizona. Tech. Bull. 215. Tucson, AZ: University of Arizona, Agricultural Experiment Station. 38 p.
- Forsling, C. L. 1931. A study of the influence of herbaceous plant cover on surface runoff and soil erosion in relation to grazing on the Wasatch Plateau in Utah. Tech. Bull. 220. Washington, DC: U.S. Department of Agriculture. 71 p.
- Gay, Lloyd W. 1985. Evapotranspiration from saltcedar along the lower Colorado River. In: Johnson, R. R.; Ziebell, C. D.; Patton, D. R.; Ffolliott, P. F.; Hamre, R. H., tech. coords. Riparian ecosystems and their management: reconciling conflicting uses: first North American riparian conference; 1985 April 16-18; Tucson, AZ. Gen. Tech. Rep. RM-120. Fort Collins, CO: U.S. Department of Agriculture, Forest Service, Rocky Mountain Forest and Range Experiment Station: 171-174.
- Gay, L. W.; Hartman, R. K. 1982. ET measurements over riparian saltcedar on the Colorado River. In: Hydrology and water resources in Arizona and the Southwest: proceedings of the 1982 meeting; 1982 April 24; Tempe, AZ. Arizona Section, American Water Resources Association and the Hydrology Section, Arizona-Nevada Academy of Science: 9-15.
- Gifford, Gerald F.; Hancock, Valdon B.; Coltharp, George B. 1978. Effects of gully plugs and contour furrows on the soil moisture regime in the Cisco Basin, Utah. Journal of Range Management. 31: 293-295.
- Goss, D. W. 1973. Relation of physical and mineralogical properties to streambank stability. Water Resources Bulletin. 9:140-144.
- Graf, W. L. 1980. Riparian management: a flood control perspective. Journal of Soil and Water Conservation. 35:158-161.
- Gregory, K. J.; Gurnell, A. M.; Hill, C. T. 1985. The permanence of debris dams related to river channel processes. Hydrological Sciences-des Sciences Hydrologiques. 30:371-381.
- Grissinger, E. H.; Bowie, A. J. 1984. Material and site controls of streambank vegetation. Transactions of the American Society of Agricultural Engineering. 27:1829-1835.
- Groeneveld, David P.; Griepentrog, Thomas E. 1985. Interdependence of groundwater, riparian vegetation and streambank stability: a case study. In: Johnson, R. R.; Ziebell, C. D.; Patton, D. R.; Ffolliott, P. F.; Hamre, R. H., tech. coords. Riparian ecosystems and their management: reconciling conflicting uses: first North American riparian conference; 1985 April 16-18; Tucson, AZ. Gen. Tech. Rep. RM-120. Fort Collins, CO: U.S. Department of Agriculture, Forest Service, Rocky Mountain Forest and Range Experiment Station: 44-48.
- Hanes, William T.; Solomon, Rhey M.; Schmidt, Larry J.; Lafayette, Russell A. 1986. Accelerated erosion risks vs. watershed condition. In: Vol. 2: proceedings, 4th federal interagency sedimentation conference; 1986 March 24-27; Las Vegas, NV: Interagency Advisory Committee on Water Data. Washington, DC: U.S. Government Printing Office: 6-9 to 6-18.
- Hansen, William R.; Kisser, Kenneth. 1988. High Clark Draw Rehabilitation: "a story of success." In: Erosion control: stay in tune: proceedings of conference XIX; 1988 February 25-26; New Orleans, LA. International Erosion Control Association: 255-266.
- Harvey, M. D.; Watson, C. C. 1986. Fluvial processes and morphological thresholds in incised channel restoration. Water Resources Bulletin. 22:359-368.
- Hayes, J. C.; Barfield, B. J.; Barnhisel, A. E. 1979. Filtration of sediment by simulated vegetation II. Unsteady flow with non-homogeneous sediment. Transactions of the American Society of Agricultural Engineering. 22:1063-1067.
- Heede, Burchard H. 1960. A study of early gully-control structures in the Colorado Front Range. Station Paper 55. Fort Collins, CO: U.S. Department of Agriculture, Forest Service, Rocky Mountain Forest and Range Experiment Station. 42 p.
- Heede, Burchard H. 1965. Multipurpose prefabricated concrete check dam. Res. Pap. RM-12. Fort Collins, CO: U.S. Department of Agriculture, Forest Service, Rocky Mountain Forest and Range Experiment Station. 16 p.
- Heede, Burchard H. 1966. Design, construction and cost of rock check dams. Res. Pap. RM-20. Fort Collins, CO: U.S. Department of Agriculture, Forest Service, Rocky Mountain Forest and Range Experiment Station. 24 p.
- Heede, Burchard H. 1968. Conversion of gullies to vegetation-lined waterways on mountain slopes. Res. Pap. RM-40. Fort Collins, CO: U.S. Department of Agriculture, Forest Service, Rocky Mountain Forest and Range Experiment Station. 11 p.
- Heede, Burchard H. 1971. Characteristics and processes of soil piping in gullies. Res. Pap. RM-68. Fort Collins, CO: U.S. Department of Agriculture, Forest Service, Rocky Mountain Forest and Range Experiment Station. 15 p.
- Heede, Burchard H. 1972. Influences of a forest on the hydraulic geometry of two mountain streams. Water Resources Bulletin. 8:523-530.
- Heede, Burchard H. 1975. Submerged burlap strips aided rehabilitation of disturbed semi-arid sites in Colorado and New Mexico. Res. Note RM-302. Fort Collins, CO: U.S. Department of Agriculture, Forest Service, Rocky Mountain Forest and Range Experiment Station. 8 p.
- Heede, Burchard H. 1976. Gully development and control: the status of our knowledge. Res. Pap. RM-169. Fort Collins, CO: U.S. Department of Agriculture, Forest Service, Rocky Mountain Forest and Range Experiment Station. 42 p.
- Heede, Burchard H. 1977. A case study of a watershed rehabilitation project: Alkali Creek, Colo. Res. Pap.

- RM-189. Fort Collins, CO: U.S. Department of Agriculture, Forest Service, Rocky Mountain Forest and Range Experiment Station. 18 p.
- Heede, Burchard H. 1978. Designing gully control systems for eroding watersheds. *Environmental Management*. 2:509-522.
- Heede, Burchard H. 1980. Stream dynamics: an overview for land managers. Gen. Tech. Rep. RM-72. Fort Collins, CO: U.S. Department of Agriculture, Forest Service, Rocky Mountain Forest and Range Experiment Station. 26 p.
- Heede, Burchard H. 1981. Dynamics of selected streams in the Western United States of America. *Zeitschrift für Geomorphologie* 25:17-32.
- Heede, Burchard H. 1982. Gully control: determining treatment priorities for gullies in a network. *Environmental Management*. 6:441-451.
- Heede, Burchard H. 1985a. Interaction between streamside vegetation and stream dynamics. In: Johnson, R. R.; Ziebell, C. D.; Patton, D. R.; Ffolliott, P. F.; Hamre, R. H., tech. coords. Riparian ecosystems and their management: reconciling conflicting uses: first North American riparian conference; 1985 April 16-18; Tucson, AZ. Gen. Tech. Rep. RM-120. Fort Collins, CO: U.S. Department of Agriculture, Forest Service, Rocky Mountain Forest and Range Experiment Station: 54-58.
- Heede, Burchard H. 1985b. Channel adjustments to the removal of log steps: an experiment in a mountain stream. *Environmental Management*. 9:427-432.
- Heede, Burchard H. 1986. Designing for dynamic equilibrium in streams. *Water Resources Bulletin*. 22:351-357.
- Heede, Burchard H. 1988. The influence of vegetation and its spatial distribution on sediment delivery from selected Arizona forests and woodlands. In: Erosion control: stay in tune: proceedings of conference XIX; 1988 February 25-26; New Orleans, LA. International Erosion Control Association: 383-392.
- Heede, Burchard H.; DeBano, Leonard F. 1984. Gully rehabilitation: a three-stage process. *Soil Science Society of America Journal*. 48:1416-1422.
- Heede, Burchard H.; Harvey, Michael D.; Laird, Jeffrey R. 1988. Sediment delivery linkages in a chaparral watershed following a wildfire. *Environmental Management*. 12:349-358.
- Heede, Burchard H.; Mufich, John H. 1973. Functional relationships and a computer program for structural gully control. *Journal of Environmental Management*. 1:321-344.
- Heede, Burchard H.; Mufich, John H. 1974. Field and computer procedures for gully control by check dams. *Journal of Environmental Management*. 2:1-49.
- Hendrickson, D. A.; Minckley, W. L. 1985. Cienegas—vanishing climax communities of the American Southwest. *Desert Plants*. 6:130-175.
- Hewlett, J. D.; Hibbert, A. R. 1963. Moisture and energy conditions within a sloping soil mass during drainage. *Journal of Geophysical Research*. 68:1081-1087.
- Hewlett, J. D.; Troendle, C. A. 1975. Non-point diffused water sources: a variable source area problem. In: Watershed management: proceedings of a symposium; New York, NY. American Society of Civil Engineers: 21-45.
- Hibbert, Alden R. 1971. Increases in streamflow after converting chaparral to grass. *Water Resources Research*. 7:71-80.
- Hibbert, Alden R. 1979. Managing vegetation to increase flow in the Colorado River Basin. Gen. Tech. Rep. RM-66. Fort Collins, CO: U.S. Department of Agriculture, Forest Service, Rocky Mountain Forest and Range Experiment Station. 27 p.
- Hibbert, A. R.; Davis, E. A. 1986. Streamflow response to converting Arizona chaparral in a mosaic pattern. *Hydrology and Water Resources in Arizona and the Southwest*. 16:123-131.
- Hibbert, A. R.; Davis, E. A.; Knipe, O. D. 1982. Water yield changes resulting from treatment of Arizona chaparral. In: Dynamics and management of mediterranean-type ecosystems: proceedings of the symposium; 1982 June 22-26; San Diego, CA. Gen. Tech. Rep. PSW-58. Berkeley, CA: U.S. Department of Agriculture, Forest Service, Pacific Southwest Forest and Range Experiment Station: 382-389.
- Hibbert, Alden R.; Davis, Edwin A.; Scholl, David G. 1974. Chaparral conversion potential in Arizona: part I: water yield response and effects on other resources. Res. Pap. RM-126. Fort Collins, CO: U.S. Department of Agriculture, Forest Service, Rocky Mountain Forest and Range Experiment Station. 36 p.
- Hill, L. W.; Rice, R. M. 1963. Converting from brush to grass increases water yields in southern California. *Journal of Range Management*. 16:300-305.
- Horton, Jerome S. 1964. Notes on the introduction of deciduous tamarisk. Res. Note RM-16. Fort Collins, CO: U.S. Department of Agriculture, Forest Service, Rocky Mountain Forest and Range Experiment Station. 7 p.
- Horton, Jerome S. 1973. Evapotranspiration and water research as related to riparian and phreatophyte management. Misc. Publ. 1234. Washington, DC: U.S. Department of Agriculture, Forest Service. 192 p.
- Horton, Jerome S. 1977. The development and perpetuation of the permanent Tamarisk type in the phreatophyte zone of the Southwest. In: Johnson, R. R.; Jones, D. A., tech coords. Importance, preservation and management of riparian habitat: a symposium. Gen. Tech. Rep. RM-43, Fort Collins, CO: U.S. Department of Agriculture, Forest Service, Rocky Mountain Forest and Range Experiment Station: 124-127.
- Horton, Jerome S.; Campbell, C. J. 1974. Management of phreatophyte and riparian vegetation for maximum multiple use values. Res. Pap. RM-117. Fort Collins, CO: U.S. Department of Agriculture, Forest Service, Rocky Mountain Forest and Range Experiment Station. 23 p.
- Horton, Robert E. 1937. Hydrologic aspects of the problem of stabilizing streamflow. *Journal of Forestry*. 35:1015-1027.
- Hull, A. C., Jr. 1973. Duration of seeded stands on terraced mountain lands, Davis County, Utah. *Journal of Range Management*. 26:133-136.

- Jackson, William; Martinez, Tony; Cuplin, Paul; Minckley, W. L.; Shelby, Bo; Summers, Paul; McGlothlin, Dan; Van Haveren, Bruce. 1987. Assessment of water conditions and management opportunities in support of riparian values: BLM San Pedro River properties, Arizona project completion report BLM/YA/PT 88/004 + 7200. Denver, CO: U.S. Department of Interior, Bureau of Land Management Service Center. 180 p.
- Jackson, W. L.; Van Haveren, B. P. 1984. Design for a stable channel in coarse alluvium for riparian zone restoration. *Water Resources Bulletin*. 20:695-703.
- Johnson, J. R.; Ziebell, C. D.; Patton, D. R.; Ffolliott, P. F.; Hamre, R. H., tech. coords. 1985. Riparian ecosystems and their management: reconciling conflicting uses: first North American riparian conference; 1985 April 16-18; Tucson, AZ. Gen. Tech. Rep. RM-120. Fort Collins, CO: U.S. Department of Agriculture, Forest Service, Rocky Mountain Forest and Range Experiment Station. 523 p.
- Johnson, Roy D.; Carothers, Steven W. 1982. Riparian habitats and recreation: interrelationships and impacts in the Southwest and Rocky Mountain Region. Eisenhower Consortium Bulletin 12. Fort Collins, CO: U.S. Department of Agriculture, Forest Service, Rocky Mountain Forest and Range Experiment Station. 31 p.
- Johnson, R. D.; Carothers, S. W.; Simpson, J. M. 1984. A riparian classification system. In: Warner, R. E.; Hendrix, K. M., eds. *California riparian systems*. Berkeley, CA: University of California Press: 375-382.
- Johnson, Roy D.; Lowe, Charles H. 1985. On the development of riparian ecology. In: Johnson, R. R.; Ziebell, C. D.; Patton, D. R.; Ffolliott, P. F.; Hamre, R. H., tech. coords. Riparian ecosystems and their management: reconciling conflicting uses: first North American riparian conference; 1985 April 16-18; Tucson, AZ. Gen. Tech. Rep. RM-120. Fort Collins, CO: U.S. Department of Agriculture, Forest Service, Rocky Mountain Forest and Range Experiment Station: 112-116.
- Kearney, Thomas H.; Peebles, Robert H. 1951. *Arizona Flora*. Berkeley, CA: University of California Press. 1032 p.
- Keppel, R. V.; Renard, K. G. 1962. Transmission losses in ephemeral stream beds. *Proceedings of the American Society of Civil Engineers, Journal of the Hydraulics Division*. 3:59-68.
- Lafayette, Russell A.; Pawelek, David G. 1989. New revetment design controls streambank erosion. In: *Proceedings of Conference XX, International Erosion Control Association*; Vancouver, British Columbia, Canada.
- Lane, E. W. 1955. The importance of fluvial morphology in hydraulic engineering. *Proceedings of the American Society of Civil Engineering, Journal of the Hydraulics Division*. 81:745-1 to 745-17.
- Leaf, C. F. 1966. Sediment yields from high mountain watersheds, central Colorado. Res. Pap. RM-23. Fort Collins, CO: U.S. Department of Agriculture, Forest Service, Rocky Mountain Forest and Range Experiment Station. 15 p.
- Leopold, Aldo. 1946. Erosion as a menace to the social and economic future of the Southwest. *Journal of Forestry*. 44:627-633.
- Lowe, Charles H.; Johnson, R. Roy; Bennett, Peter S. 1986. Riparian lands are wetlands: the problem of applying Eastern American concepts and criteria to environments in the North American Southwest. *Hydrology and Water Resources in Arizona and the Southwest*. 16:119-122.
- Lowrance, R. Richard; Todd, Robert L.; Asmussen, Loris E. 1984a. Nutrient cycling in an agricultural watershed: I. Phreatic movement. *Journal of Environmental Quality*. 13:27-32.
- Lowrance, R. Richard; Todd, Robert L.; Asmussen, Loris E. 1984b. Nutrient cycling in an agricultural watershed: II. Streamflow and artificial discharge. *Journal of Environmental Quality*. 13:27-32.
- Lowrance, Richard; Todd, Robert; Fuil, Joseph, Jr.; Hendrickson, Ole; Leonard, Ralph; Asmussen, Loris. 1984c. Riparian forest as nutrient filters in agricultural watersheds. *Bioscience*. 34:374-377.
- Lowrance, Richard; Leonard, Ralph; Sheridan, Joseph. 1985. Managing riparian ecosystems to control nonpoint pollution. *Journal of Soil and Water Conservation*. 40:87-91.
- Lowrance, Richard; Sharpe, Julie K.; Sheridan, Joseph M. 1986. Long-term sediment deposition in the riparian zone of a coastal plain watershed. *Journal of Soil and Water Conservation*. 41:266-271.
- Lusby, Gregg C. 1970. Hydrologic and biotic effects of grazing vs. non-grazing near Grand Junction, Colorado. *Journal of Range Management*. 23:256-260.
- Lusby, G. C.; Hadley, R. F. 1967. Deposition behind low dams and barriers in the south-western United States. *Journal of Hydrology (N.Z.)*. 6:89-105.
- Mackintosh, Loraine. 1984. The day the valley shook. *The Cochise Quarterly*. 14:3-8.
- McGlothlin, D.; Jackson, W. J.; Summers, P. 1988. Groundwater, geomorphic processes, and riparian values: San Pedro River, Arizona. In: *Water use data for water resources management: proceedings of the symposium*; Tucson, AZ. American Water Resources Association: 537-545.
- Megahan, W. F. 1981. Effects of silvicultural practices on erosion and sedimentation in the Interior West—a case for sediment budgeting. In: Baumgartner, D. M., ed. *Interior West watershed management: proceedings of a symposium*; 1980 April 8-10; Pullman, WA. Washington State University: 169-181.
- Megahan, W.F. 1982. Channel sediment storage behind obstructions in forested drainage basins draining the granitic bedrock of the Idaho batholith. In: Swanson, F. J.; Janda, R. J.; Dunne, T.; Swanson, D. N., tech. coords. *Sediment budgets and routing in forested drainage basins*. Gen. Tech. Rep. PNW-141. Portland, OR: U.S. Department of Agriculture, Forest Service, Pacific Northwest Forest and Range Experiment Station: 113-121.
- Melton, M. A. 1965. The geomorphic and paleoclimatic significance of alluvial deposits in southern Arizona. *Journal of Geology*. 73:1-38.

- Minckley, W. L.; Rinne, John N. 1985. Large woody debris in hot-desert streams: a historical review. *Desert Plants*. 7:142-153.
- Orme, A. R.; Bailey, R. G. 1970. The effect of vegetation conversion and flood discharge on stream channel geometry: the case of southern California watersheds. *Proceedings of the Association of American Geographers*. 2:101-106.
- Orme, A. R.; Bailey, R. G. 1971. Vegetation conversion and channel geometry in Monroe Canyon, southern California. *Yearbook of the Association of Pacific Coast Geographers*. 33:65-82.
- Packer, Paul E. 1953. Effects of trampling disturbance on watershed condition, runoff, and erosion. *Journal of Forestry*. 51:28-31.
- Parker, M. F.; Wood, F. J., Jr.; Smith, B. H.; Elder, R. G. 1985. Erosional downcutting in lower order riparian ecosystems: have historical changes been caused by removal of beaver? In: Johnson, R. R.; Ziebell, C. D.; Patton, D. R.; Ffolliott, P. F.; Hamre, R. H., tech. coords. *Riparian ecosystems and their management: reconciling conflicting uses: first North American riparian conference; 1985 April 16-18; Tucson, AZ. Gen. Tech. Rep. RM-120. Fort Collins, CO: U.S. Department of Agriculture, Forest Service, Rocky Mountain Forest and Range Experiment Station: 35-38.*
- Peterjohn, W. T.; Correll, D.L. 1984. Nutrient dynamics in an agricultural watershed: observations on the role of a riparian forest. *Ecology*. 65:1466-1475.
- Peverly, J. H. 1982. Stream transport of nutrients through a wetland. *Journal of Environmental Quality*. 11:38-43.
- Platts, William S.; Armour, Carl; Booth, Bordon D., et al. 1987. Methods for evaluating riparian habitats with applications to management. *Gen. Tech. Rep. INT-221. Ogden, UT: U.S. Department of Agriculture, Forest Service, Intermountain Research Station. 177 p.*
- Platts, William S.; Gebhardt, Karl A.; Jackson, William L. 1985. The effects of large storm events on basin-range riparian stream habitats. In: Johnson, R. R.; Ziebell, C. D.; Patton, D. R.; Ffolliott, P. F.; Hamre, R. H., tech. coords. *Riparian ecosystems and their management: reconciling conflicting uses: first North American riparian conference; 1985 April 16-18; Tucson, AZ. Gen. Tech. Rep. RM-120. Fort Collins, CO: U.S. Department of Agriculture, Forest Service, Rocky Mountain Forest and Range Experiment Station: 30-34.*
- Platts, William S.; Raleigh, Robert F. 1984. Impacts of grazing on wetlands and riparian habitat. In: *Developing strategies for rangeland management. A report prepared by the committee on developing strategies for rangeland management. Washington, DC: National Research Council, National Academy of Sciences: 1105-1117.*
- Platts, William S.; Rinne, John N. 1985. Riparian and stream enhancement management and research in the Rocky Mountains. *North American Journal of Fisheries Management*. 5:115-125.
- Quaife, M. M., ed. 1930. *The personal narrative of James O. Pattie of Kentucky. Chicago, IL: Lakeside Press, R. R. Donolley Co. 428 p.*
- Rhodes, Jonathan; Skau, C. M.; Greenlee, Daniel; Brown, David L. 1985. Quantification of nitrate uptake by riparian forests and wetlands in an undisturbed headwaters watershed. In: Johnson, R. R.; Ziebell, C. D.; Patton, D. R.; Ffolliott, P. F.; Hamre, R. H., tech. coords. *Riparian ecosystems and their management: reconciling conflicting uses: first North American riparian conference; 1985 April 16-18; Tucson, AZ. Gen. Tech. Rep. RM-120. Fort Collins, CO: U.S. Department of Agriculture, Forest Service, Rocky Mountain Forest and Range Experiment Station: 175-175.*
- Rice, R. M.; Corbett, E. S.; Bailey, R. G. 1969. Soil slips related to vegetation, topography, and soil in southern California. *Water Resources Research*. 5: 647-659.
- Rice, R. M.; Crouse, R. P.; Corbett, E. S. 1965. Emergency measures to control erosion after a fire on the San Dimas Experimental Forest. In: *Proceedings of the federal inter-agency conference on sedimentation. Misc. Publ. 970: 123-130.*
- Rice, R. M.; Rothacher, J. S.; Megahan, W. F. 1972. Erosional consequences of timber harvesting: an appraisal. In: *Series 14, watershed in transition: proceedings of a national symposium; 1972 June 19-22; Fort Collins, CO. Urbana, IL: American Water Resources Association: 321-329.*
- Rich, L. R.; Gottfried, G. J. 1976. Water yields resulting from treatments on the Workman Creek Experimental Watersheds in central Arizona. *Water Resources Research*. 12: 1053-1060.
- Rich, Lowell, R.; Reynolds, Hudson G. 1963. Grazing in relation to runoff and erosion on some chaparral watersheds in central Arizona. *Journal of Range Management*. 16: 322-326.
- Rich, Lowell R.; Thompson, J. R. 1974. Watershed management in Arizona's mixed conifer forests: the status of our knowledge. *Res. Pap. RM-130. Fort Collins, CO: U.S. Department of Agriculture, Forest Service, Rocky Mountain Forest and Range Experiment Station. 15 p.*
- Riggan, P. J.; Lockwood, R. N.; Lopez, N. 1985. Deposition and processing of airborne nitrogen pollutants in Mediterranean-type ecosystems of southern California. *Environmental Science and Technology*. 19:781-789.
- Rinne, John N. 1988. Grazing effects on stream habitat and fishes: research design considerations. *North American Journal of Fisheries Management* 8:240-247.
- Ritzi, Robert W.; Bouwer, Herman; Sorooshian, Soroosh. 1985. Water resource conservation by reducing phreatophyte transpiration. In: Johnson, R. R.; Ziebell, C. D.; Patton, D. R.; Ffolliott, P. F.; Hamre, R. H., tech. coords. *Riparian ecosystems and their management: reconciling conflicting uses: first North American riparian conference; 1985 April 16-18; Tucson, AZ. Gen. Tech. Rep. RM-120. Fort Collins, CO: U.S. Department of Agriculture, Forest Service, Rocky Mountain Forest and Range Experiment Station: 191-196.*
- Rosgen, David L. 1985. A stream classification system. In: Johnson, R. R.; Ziebell, C. D.; Patton, D. R.; Ffolliott, P. F.; Hamre, R. H., tech. coords. *Riparian ecosystems and their management: reconciling conflicting uses: first North American riparian conference; 1985 April 16-18; Tucson, AZ. Gen. Tech. Rep. RM-120. Fort*

- Collins, CO: U.S. Department of Agriculture, Forest Service, Rocky Mountain Forest and Range Experiment Station: 91-95.
- Rowe, P. B. 1963. Streamflow increases after removing woodland-riparian vegetation from a southern California watershed. *Journal of Forestry*. 61:365-370.
- Ruby, Earl C. 1973. Evaluation of check dams for sediment control. Unnumbered report. Los Angeles River Watershed, Los Angeles, CA: Angeles National Forest, Region 5. 59 p.
- Ruby, Earl C. 1974. Review report of Los Angeles River Flood Prevention Project, mountain and foothill area. Unnumbered report. Los Angeles, CA: U.S. Department of Agriculture, Angeles National Forest, California Region. 82 p.
- Schlusser, I. J.; Karr, J. R. 1981a. Riparian vegetation and channel morphology impact on spatial patterns of water quality in agricultural watersheds. *Environmental Management*. 5:233-243.
- Schlusser, I. J.; Karr, J. R. 1981b. Water quality in agricultural watersheds: impact of riparian vegetation during base flow. *Water Resources Bulletin*. 17:233-240.
- Schultze, Ronald F.; Wilcox, Glenn I. 1985. Emergency measures for streambank stabilization. In: Johnson, R. R.; Ziebell, C. D.; Patton, D. R.; Ffolliott, P. F.; Hamre, R. H., tech. coords. Riparian ecosystems and their management: reconciling conflicting uses: first North American riparian conference; 1985 April 16-18; Tucson, AZ. Gen. Tech. Rep. RM-120. Fort Collins, CO: U.S. Department of Agriculture, Forest Service, Rocky Mountain Forest and Range Experiment Station: 59-61.
- Schumann, H. H.; Thomsen, B. W. 1972. Hydrologic regimen of Lower Tonto Creek Basin, Gila County, Arizona. A reconnaissance study. *Arizona Water Commission Bulletin* 3. U.S. Geological Survey: 391.
- Schumm, S. A.; Harvey, M. D.; Watson, C. C. 1984. Incised channels: morphology, dynamics, and control. Littleton, CO: Water Resources Publications. 200 p.
- Skinner, Q. 1986. Riparian zones then and now. In: Brosz, D. J.; Rodgers, J. D., tech. coords. Proceedings, Wyoming water 1986 and streamside zone conference; 1986 April 28-30; Casper, WY. Laramie, WY: University of Wyoming, Wyoming Water Research Center: 8-22.
- Skovlin, Jon M. 1984. Impacts of grazing on wetlands and riparian habitat: a review of our knowledge. In: Developing strategies for rangeland management. A report prepared by the committee on developing strategies for rangeland management. Washington, DC: National Research Council, National Academy of Sciences: 1001-1103.
- Solomon, Rhey M.; Maxwell, James R.; Schmidt, Larry J. 1982. Determining watershed condition and treatment priorities. In: Proceedings, hydrology and water resources in Arizona and the Southwest; 1982 April 24; Tempe, AZ: 27-36.
- Stabler, D. Frederic. 1985. Increasing summer flow in small streams through management of riparian areas and adjacent vegetation: a synthesis. In: Johnson, R. R.; Ziebell, C. D.; Patton, D. R.; Ffolliott, P. F.; Hamre, R. H., tech. coords. Riparian ecosystems and their management: reconciling conflicting uses: first North American riparian conference; 1985 April 16-18; Tucson, AZ. Gen. Tech. Rep. RM-120. Fort Collins, CO: U.S. Department of Agriculture, Forest Service, Rocky Mountain Forest and Range Experiment Station: 206-210.
- State of California. 1970. Bank and shore protection in California highway practice. Sacramento, CA: Department of Transportation, State of California. 423 p.
- Stephens, D. A. 1985. Physical considerations in groundwater recharge. In: Water and science: proceedings of the symposium; 1985 April; Las Cruces, NM. New Mexico State University, New Mexico Water Resources Research Institute: 92-108.
- Stephens, D. B.; Knowlton, R., Jr. 1986. Soil water movement and recharge through sand at a semiarid site in New Mexico. *Water Resources Research*. 22:881-889.
- Stevens, Lawrence E.; Waring, Gwendolyn L. 1985. The effects of prolonged flooding on the riparian plant community in Grand Canyon. In: Johnson, R. R.; Ziebell, C. D.; Patton, D. R.; Ffolliott, P. F.; Hamre, R. H., tech. coords. Riparian ecosystems and their management: reconciling conflicting uses: first North American riparian conference; 1985 April 16-18; Tucson, AZ. Gen. Tech. Rep. RM-120. Fort Collins, CO: U.S. Department of Agriculture, Forest Service, Rocky Mountain Forest and Range Experiment Station: 81-86.
- Swanson, Frederick J.; Bryant, Mason D.; Lienkaemper, George W.; Sedell, James R. 1984. Organic debris in small streams, Prince of Wales Island, Southeast Alaska. Gen. Tech. Rep. PNW-166. Portland, OR: U.S. Department of Agriculture, Forest Service, Pacific Southwest Forest and Range Experiment Station. 12 p.
- Swanson, F. J.; Gregory, S. V.; Sedell, J. R.; Campbell, A. G. 1982. Land-water interactions: the riparian zone. In: Rovert, L., ed. Analyses of coniferous forest ecosystems in the western United States. US/IBP Synthesis Series 14. Stroudsburg, PA: Hutchinson Ross Publishing Company. 419 p.
- Swanson, Sherman; Miles, Ray; Leonard, Steve; Genz, Kenneth. 1988. Classifying the rangeland riparian areas: the Nevada Task Force approach. *Journal of Soil and Water Conservation*. 43:259-263.
- Szaro, Robert C. 1981. Bird population responses to converting chaparral to grassland and riparian habitats. *The Southwestern Naturalist*. 26(3):251-256.
- Szaro, Robert C. 1989. Riparian forest and scrubland community types of Arizona and New Mexico. *Desert Plants*. 9(3-4):69-138.
- Szaro, Robert C.; DeBano, Leonard F. 1985. The effects of streamflow modification on the development of a riparian ecosystem. In: Johnson, R. R.; Ziebell, C. D.; Patton, D. R.; Ffolliott, P. F.; Hamre, R. H., tech. coords. Riparian ecosystems and their management: reconciling conflicting uses: first North American riparian conference; 1985 April 16-18; Tucson, AZ. Gen. Tech. Rep. RM-120. Fort Collins, CO: U.S. Department of Agriculture, Forest Service, Rocky Mountain Forest and Range Experiment Station: 211-215.

- Thomas, Jack Ward; Masser, Chris; Rodiek, Jon E. 1979. Riparian zones. In: Wildlife habitats in managed forest the Blue Mountains of Oregon and Washington. In: Thomas, J. W., ed. Agric. Handb. 553. Washington, DC: U.S. Department of Agriculture, Forest Service: 40-75.
- Thomsen, B. W.; Schumann, H. H. 1968. Water resources of the Sycamore Creek watershed, Maricopa County, Arizona. Water Supply Paper 1861. Washington, DC: U.S. Geological Survey. 53 p.
- Turner, R. M.; Karpiscak, M. M. 1980. Recent vegetation changes along the Colorado River between Glen Canyon Dam and Lake Mead, Arizona. Prof. Pap. 1132. Washington, DC: U.S. Geological Survey. 125 p.
- United States Army. 1962. Report on measures for bank protection: use of steel jetties on alluvial streams. Albuquerque, NM: U.S. Army, Corp of Engineers. Albuquerque Corps of Engineers. 17 p.
- United States Army. 1984. Stream protection guidelines. Vicksburg, MS: U.S. Army Corps of Engineers. Waterways Experimental Station. 69 p.
- U.S. General Accounting Office. 1988. Public rangelands—some riparian areas restored but widespread improvement will be slow. U.S. General Accounting Office, Report to Congressional Requesters. GAO/RCED-88-105. 85 p.
- U.S. Department of Agriculture, Forest Service. 1986. U.S. Department of Agriculture, Forest Service, Manual Section 2526.05, Definitions. FSM 3/86 Amend 48. 1 p.
- Van Haveren, Bruce P. 1986. Management of instream flows through runoff detention and retention. Water Resources Bulletin. 22:399-404.
- Van Haveren, Bruce P.; Jackson, William L. 1986. Concepts in stream riparian rehabilitation. Presentation at the Wildlife management institute fifty-first North American wildlife and natural resources conference; 1986 March 21-26; Reno, NV. 19 p.
- Van Haveren, Bruce P.; Jackson, William L.; Lusby, Gregg C. 1987. Sediment deposition behind Sheep Creek Barrier Dam, southern Utah. Journal of Hydrology (N.Z.). 26(2):185-196.
- Vines, Robert A. 1960. Trees, shrubs, and woody vines of the Southwest. Austin, TX: University of Texas Press. 1104 p.
- Ward, Timothy J.; Baker, Malchus B., Jr. 1984. Sediment from managed pine watershed in northern central Arizona. In: Irrigation and drainage division: proceedings of the specialty conference; 1984 July 24-26; Flagstaff, AZ. American Society of Civil Engineers: 552-558.
- Williams, Garnett P.; Wolman, M. Gordon. 1984. Downstream effects of dams on alluvial rivers. Professional Paper 1286. Washington, DC: U.S. Geological Survey. 64 p.
- Wolman, M. Gordon. 1977. Changing needs and opportunities in the sediment field. Water Resources Research. 13:50-54.
- Woodward, Lowell; Craddock, George W. 1945. Surface runoff potentials of some Utah range-watershed lands. Journal of Forestry. 43:357-365.
- Zauderer, Jeffrey. 1987. Desert riparian habitats of the Sierrita Mountains south of Tucson, Arizona. In: Multz, K. M.; Lee, L. C., tech. coords. Proceedings of the Society of wetland scientists' eighth annual meeting. Wetlands and Riparian Ecosystems of the American West; 1987 May 26-29; Seattle, WA: 14.

APPENDIX A

Discussion of Riparian Terminology

Riparian areas may be defined in a variety of ways, based on factors such as vegetation type, groundwater and surface water hydrology, topography, and ecosystem function (Swanson et al. 1982). These factors have so many complex interactions that defining the riparian area in one sense integrates elements of several other factors. Riparian areas are viewed as important islands of diversity within extensive forest and rangeland ecosystems throughout the West, and often support complex mosaics of plant communities associated with a unique combination of soil and hydrologic characteristics (Platts et al. 1987).

Riparian areas are generally characterized by environmental processes markedly different from those prevailing on upland sites. For this reason, many western forest and rangeland classification concepts are not useful for describing riparian areas. Riparian areas are geomorphically active, with periodic natural disturbances affecting soil and hydrologic characteristics. Water tables may be subject to fluctuations at relatively frequent intervals (Platts et al. 1987). However, riparian vegetation community types represent more than current floristic units. These types can be fairly well correlated with soil and environmental characteristics so reliable inferences can be drawn regarding environmental gradients and successional relations between types. Therefore, riparian vegetation communities cannot be termed "habitat types." The latter term refers to areas of land capable of supporting long-term stable (climax) communities, a situation seldom realized in riparian areas.

Webster defines riparian as "of relating to, or living on the bank of a river, lake, etc." and is derived from the Latin *riparius* meaning bank or shore, as of a stream or river. This original meaning has been largely retained, and is used to describe terrestrial, moist soil zones immediately landward of aquatic wetlands, other freshwater bodies, both perennial and intermittent watercourses, and many estuaries. Numerous other specific definitions have also been proposed. For example, The Society for Range Management (Anderson 1987) defines "riparian zones, or areas, are the banks and adjacent areas of water bodies, water courses, seeps, and springs whose water provide soil moisture sufficiently in excess of that otherwise available locally so as to provide a more moist habitat than that of contiguous flood plains and uplands." The Bureau of Land Management (Anderson 1987) states "riparian areas are zones of transition from aquatic terrestrial ecosystems, whose presence is dependent upon surface and/or subsurface water, and which the influence of water reveals through their ex-

isting or potential soil-vegetation complex. Riparian areas may be associated with features, such as lakes, reservoirs, estuaries, potholes, springs, bogs, wet meadows, muskegs, and ephemeral, intermittent or perennial streams." A definition suggested by Anderson (1987) is "a riparian area is a distinct ecological site, or combination of sites, in which soil moisture is sufficiently in excess of that otherwise available locally, due to run-on and/or subsurface seepage, so as to result in an existing or potential soil-vegetation complex that depicts the influence of that extra soil moisture." Riparian areas may be associated with lakes, reservoirs, estuaries, potholes, springs, bogs, wet meadows, muskegs, and intermittent or perennial streams. The distinctive soil-vegetation complex is often the differentiating criterion.

Ecologists in the eastern United States tend to be more restrictive than those in the arid West when using the term "riparian" (Johnson and Carothers 1982, Lowe et al. 1986). Many eastern biologists would restrict the definition of riparian areas to the habitats closely paralleling bottomlands, floodplains, or first terraces along flowing streams. In the eastern environment, riparian plant communities may not differ greatly from upland plant communities (Johnson and Lowe 1985). Investigators in arid sections of the West commonly extend the use of the term to include banks of arroyos that may flow only a few days each year, at best, and even to desert oases.

Most water sources, whether surface or ground water near the surface, in desert areas will have associated distinctive riparian vegetative assemblages. In an arid or semiarid environment, the riparian plant communities form linear woodlands that are framed sharply by contrasting deserts, scrublands, and forests of the surrounding uplands. Because water is an overriding factor in western riparian ecology, it has been proposed that streams be divided into three basic types of flow regimes: (a) perennial—associated with permanent water; (b) intermittent—areas where water is available for only a few months of the year, often during one or two seasons; and (c) ephemeral—found along watercourses which flow irregularly for short periods (less than 1 month) after local precipitation (Johnson et al. 1984). Most of the discussions in this paper concerned with the enhancement of riparian areas using watershed practices in the Southwest will be focused on upland areas and, to some extent, the lower elevation desert environments. Many of these areas would be classified as intermittent and ephemeral before treatment, and perennial following rehabilitation or enhancement.

APPENDIX B

Plant species follow Kearney and Peebles (1951) and Vines (1960).

Trees, Shrubs, and Grasslike Plants

Scientific Name and Authority	Common Name
<i>Acer grandidentatum</i> Nutt.	bigtooth maple
<i>Alnus oblongifolia</i> Torr.	Arizona alder
<i>Baccharis</i> sp.	Baccharis
<i>Baccharis sarothroides</i> Gray	broom baccharis
<i>Carex</i> sp.	sedge
<i>Cercocarpus betuloides</i> Nutt.	birchleaf mountainmahogany
<i>Juglans major</i> (Torr.) Heller	Arizona walnut
<i>Quercus emoryi</i> Torr.	Emory oak
<i>Quercus gambelii</i> Nutt.	Gambel oak
<i>Quercus turbinella</i> Greene	shrub live oak
<i>Olneya tesota</i> Gray.	ironwood
<i>Populus</i> sp.	cottonwood
<i>Populus fremontii</i> Wats.	Fremont cottonwood
<i>Prosopis juliflora</i>	common mesquite
<i>Prosopis velutina</i> (Woot.)	velvet mesquite
<i>Rhus ovata</i> Wats.	sugar sumac
<i>Salix</i> sp.	willow
<i>Salix goodingii</i> Ball.	Gooding willow
<i>Salix laevigata</i> Bebb.	red willow
<i>Tamarix pentandra</i> Pall.	saltcedar

ACKNOWLEDGMENTS

The authors acknowledge Dr. Burchard H. Heede, Research Hydrologist, USFS, Tempe, Arizona, for providing photographs of channel structures at Alkali Creek, Colorado, and Mr. William R. Hansen, National Park Service, Fort Collins, Colorado for suggestions and initial drawings for figures 4 and 5 and figures 3a and 3b.

The authors would also like to acknowledge the following reviewers who provided indepth technical comments on the manuscript during various stages of review: Dr. Malchus Baker, Research Hydrologist; Dr. Burchard H. Heede, Hydrologist; Dr. John Rinne, Research Fisheries Scientist; Dr. Robert Szaro, Research Wildlife Scientist (currently with USFS, FER, Washington, DC), USFS, Rocky Mountain Forest and Range Experiment Station, Tempe, Arizona; Dr. John H. Brock, Associate Professor, Arizona State University, Tempe; Mr. Tom Collins, Hydrologist, USFS, Intermountain, Ogden Utah; Mr. Robert D. Doty, Air Resources Management, USFS, Pacific Southwest Region, San Francisco, California; Dr. Lee Edleman, Department of Rangeland Resources, Oregon State University, Corvallis; Mr. William R. Hansen, Hydrologist, USFS, Gila National Forest, Silver City, New Mexico (currently with U.S. Park Service, Fort Collins, Colorado); Ms. Winifred Hodge, Hydrologist, Engineering Division, Department of the Army, Corps of Engineers, Champaign, Illinois; Dr. William Jackson and Dr. Bruce Van Haveren, Hydrologists, USDI Bureau of Land Management, Denver, Colorado (Dr. Jackson is currently with U.S. Park Service, Fort Collins, Colorado); Mr. Martin Jakel, Wildlife Biologist, USDI Bureau of Reclamation, Phoenix, Arizona; Mr. William Kenworthy, Hydrologist, Coconino National Forest, Flagstaff, Arizona; Mr. Russell A. Lafayette, Hydrologist, USFS, Southwestern Region, Albuquerque, New Mexico; Dr. Lyndon Lee, Senior Wetland Ecologist, U.S. EPA, Washington, DC; Ms. Donna Linquist, Hydrologist, Pacific Gas and Electric Company, San Ramon, California; and Dr. Sherman Swanson, Range Scientist, University of Nevada, Reno.

DeBano, Leonard F.; Schmidt, Larry J. 1989. Improving southwestern riparian areas through watershed management. Gen. Tech. Rep. RM-182. Fort Collins, CO: U.S. Department of Agriculture, Forest Service, Rocky Mountain Forest and Range Experiment Station. 33 p.

This paper reviews opportunities and watershed restoration techniques available for rehabilitating and enhancing riparian ecosystems in southwest environments. As such, it is intended to serve as a state-of-the-art report on riparian hydrology and improvement in both naturally occurring and man-made riparian areas throughout the Southwest.

Keywords: Watershed management, riparian enhancement, watershed rehabilitation

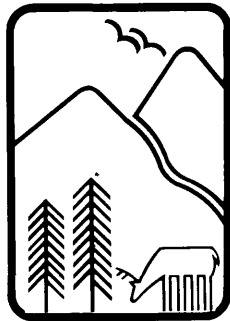

Rocky
Mountains

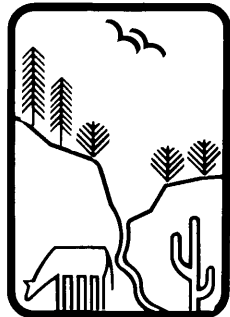

Southwest

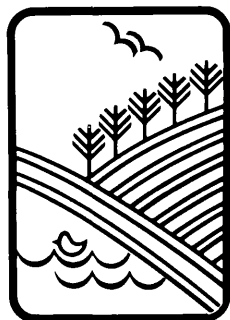

Great
Plains

U.S. Department of Agriculture
Forest Service

Rocky Mountain Forest and Range Experiment Station

The Rocky Mountain Station is one of eight regional experiment stations, plus the Forest Products Laboratory and the Washington Office Staff, that make up the Forest Service research organization.

RESEARCH FOCUS

Research programs at the Rocky Mountain Station are coordinated with area universities and with other institutions. Many studies are conducted on a cooperative basis to accelerate solutions to problems involving range, water, wildlife and fish habitat, human and community development, timber, recreation, protection, and multiresource evaluation.

RESEARCH LOCATIONS

Research Work Units of the Rocky Mountain Station are operated in cooperation with universities in the following cities:

Albuquerque, New Mexico
Flagstaff, Arizona
Fort Collins, Colorado*
Laramie, Wyoming
Lincoln, Nebraska
Rapid City, South Dakota
Tempe, Arizona

*Station Headquarters: 240 W. Prospect Rd., Fort Collins, CO 80526